

## HAEMATOKRIT 200



Ⓓ	<b>Bedienungsanleitung</b> .....	<b>9</b>
Ⓔ	<b>Operating Manual</b> .....	<b>41</b>
Ⓕ	<b>Mode d'emploi</b> .....	<b>73</b>
Ⓘ	<b>Istruzioni per l'uso</b> .....	<b>105</b>

Andreas Hettich GmbH & Co. KG  
Föhrenstraße 12, D-78532 Tuttlingen / Germany  
Phone +49 (0)7461 / 705-0  
Fax +49 (0)7461 / 705-1125  
info@hettichlab.com, service@hettichlab.com  
www.hettichlab.com



Single Registration Number:

DE-MF-000010680

© 2014 by Andreas Hettich GmbH & Co. KG

All rights reserved. No part of this publication may be reproduced without the prior written permission of the copyright owner.

Änderungen vorbehalten! , Modifications reserved! , Sous réserve de modifications ! , Con riserva di modifiche!

AB1801DEENFRIT / Rev. 09

---

**EG-Konformitätserklärung**  
**EC Declaration of conformity**  
**Déclaration de conformité CE**  
**Dichiarazione di conformità CE**

des Herstellers / of the manufacturer / du fabricant / del costruttore  
Andreas Hettich GmbH & Co. KG • Föhrenstraße 12 • D-78532 Tuttlingen • Germany

Hiermit erklären wir in alleiniger Verantwortung, dass das bezeichnete Gerät, inklusive dem mit dem Gerät konformitätsbewertetem Zubehör laut Zubehörliste der technischen Dokumentation dieses Geräts, der Richtlinie über In-vitro-Diagnostika 98/79/EG entspricht.

We hereby declare under our sole responsibility that the designated device and its accessories, which are listed in the technical documentation for this device and whose conformity has been assessed together with the device, conform to the Directive 98/79/EC on in vitro diagnostic medical devices.

Par la présente, nous déclarons sous notre seule responsabilité que l'appareil désigné, incluant ses accessoires attestés conformes d'après la liste des accessoires de la documentation technique du dit-appareil, répond à la directive 98/79/CE sur le diagnostic In-vitro.

Si dichiara nella nostra sola responsabilità, che l'apparecchiatura indicata, comprensiva dei conformi accessori come da elenco della documentazione tecnica di questa apparecchiatura, risponde alle direttive per Diagnostica In-Vitro 98/79/CE.

Geräteart / Type of device / Type d'appareil / Tipo di apparecchio:

**Gerät zur zentrifugalen Trennung von Probenmaterial menschlichen Ursprungs zur Vorbereitung in-vitro diagnostischer Analysen.**

**Device for centrifugal separation of sample material of human origin for preparation of in-vitro diagnostic analyses.**

**Appareil de séparation par force centrifuge de prélèvements humains pour la préparation In-vitro d'analyses de diagnostic.**

**Apparecchiatura per la separazione centrifugale di materiale di campione di origine umana, per la preparazione di analisi diagnostiche in vitro.**

Typenbezeichnung / Type designation / Désignation du type / Denominazione del tipo:

**HAEMATOKRIT 200**

Das Konformitätsbewertungsverfahren wurde nach Anhang III der Richtlinie 98/79/EG durchgeführt.

The conformity evaluation process was performed in accordance with appendix III of Directive 98/79/EC.

La procédure d'évaluation de la conformité a été réalisée conformément à l'annexe III de la directive 98/79/CE.

La procedura di valutazione di conformità è stata eseguita conformemente all'appendice III delle direttive 98/79/CE.

**Folgende weitere europäische Richtlinien und Verordnungen wurden angewandt:**

- Maschinenrichtlinie 2006/42/EG
- EMV-Richtlinie 2014/30/EU
- Niederspannungsrichtlinie 2014/35/EU
- RoHS II Richtlinie 2011/65/EU (ohne Beteiligung einer benannten Stelle)
- Verordnung (EG) Nr. 1907/2006 (REACH) (ohne Beteiligung einer benannten Stelle)

Angewandte Normen:

Gemäß Liste der angewandten Normen, die Teil der Produktakte ist.

---

**The following additional European directives and ordinances have been applied:**

- Machinery Directive 2006/42/EU
- EMC directive 2014/30/EU
- Low voltage directive 2014/35/EU
- RoHS II Directive 2011/65/EU (without involvement of a notified body)
- Ordinance (EC) No. 1907/2006 (REACH) (without involvement of a notified body)

**Applied standards:**

According to the list of applied standards, which is part of the product file.

**Les autres directives et normes européennes suivantes ont été appliquées:**

- Directive 2006/42/UE relative aux machines
- Directive CEM 2014/30/UE
- Directive basse tension 2014/35/UE
- Directive RoHS II 2011/65/UE (sans participation d'un organisme désigné)
- Directive (CE) no. 1907/2006 (REACH) (sans participation d'un organisme désigné)

**Normes appliquées:**

Conformément à la liste des normes appliquées relatives aux cycles du produit.

**Sono state applicate le seguenti direttive e regolamenti europei:**

- Direttive per macchine 2006/42/EU
- Direttive per compatibilità elettromagnetica 2014/30/EU
- Direttive per basse tensioni 2014/35/EU
- RoHS II direttive 2011/65/EU (senza concorso di un citato collaboratore)
- Regolamento (CE) n. 1907/2006 (REACH) (senza concorso di un citato collaboratore)

**Norme applicate:**

Conformemente alla lista delle norme applicate, che sono parte degli atti del prodotto.

Tuttlingen, 2022-08-10



Klaus Günter Ebene  
Geschäftsführer, Manager,  
Directeur, Gerente



## Contents

1	How to use these operating instructions .....	43
2	Symbol meanings .....	43
3	Intended use .....	44
4	Remaining risks .....	44
5	Technical specifications .....	45
6	Notes on safety .....	46
7	Transport and storage .....	47
7.1	Transport .....	47
7.2	Storage .....	47
8	Scope of delivery .....	47
9	Removing the transport securing device .....	48
10	Initial operation .....	48
11	Opening and closing the lid .....	49
11.1	Opening the lid .....	49
11.2	Closing the lid .....	49
12	Installation and removal of the rotor .....	50
13	Loading the rotor .....	50
14	Operating and display elements .....	51
14.1	Displayed symbols .....	51
14.2	Control panel keys .....	51
14.3	Setting options .....	52
15	Entering centrifugation parameters .....	53
15.1	Direct input of the centrifugation parameters .....	53
15.1.1	Speed (RPM) .....	53
15.1.2	Relative centrifugal force (RCF) and centrifugal radius (RAD) .....	53
15.1.3	Runtime .....	53
15.2	Input of the centrifugation parameters with the "SELECT" key .....	54
16	Centrifugation .....	56
16.1	Centrifugation with preset time .....	56
16.2	Continuous run .....	57
16.3	Short-term centrifugation .....	57
17	Emergency Stop .....	58
18	Settings and queries .....	58
18.1	Querying system information .....	59
18.2	Acoustic signal .....	61
18.3	Optical signal after ending the centrifugation run .....	62
18.4	Automatic unlocking of the lid after the centrifugation run .....	63
18.5	Backlighting of the display .....	64
18.6	Querying the hours of operation and the number of centrifugation runs .....	65
19	Relative centrifugal force (RCF) .....	66
20	Centrifugation of materials or mixtures of materials with a density higher than 1.2 kg/dm <sup>3</sup> .....	66
21	Haematocrit measurement .....	66
21.1	Determining the centrifugation time .....	66

21.2	Reading off the hematocrit value .....	66
22	Emergency unlocking .....	67
23	Maintenance and servicing.....	67
23.1	Centrifuge (housing, lid and centrifuging chamber).....	68
23.1.1	Surface cleaning and care .....	68
23.1.2	Surface disinfection .....	68
23.1.3	Removal of radioactive contaminants .....	68
23.2	Cleaning and disinfecting the haematocrit rotor .....	68
23.3	Procedure in case of broken haematocrit capillaries.....	69
23.3.1	Rotors and accessories with limited service lives .....	69
24	Faults .....	70
25	Change mains input fuses.....	71
26	Returning Devices.....	71
27	Disposal .....	72
28	Anhang / Appendix.....	138
28.1	Rotoren und Zubehör / Rotors and accessories.....	138

## 1 How to use these operating instructions

- Before using the centrifuge, read the operating instructions and observe them.
- The operating instructions are a part of the device. They must always be kept readily available.
- If the device is set up at a different location, the operating instructions must be provided with it.

## 2 Symbol meanings



Symbol on the device:  
Attention, general hazard area.



Symbol on the device:  
Observe operating instructions.  
This symbol indicates that the user must observe the operating instructions provided.



Symbol in this document:  
Attention, general hazard area.  
This symbol refers to safety relevant warnings and indicates possibly dangerous situations.  
The non-adherence to these warnings can lead to material damage and injury to personal.



Symbol on the device and in this document:  
Beware of biohazard.



Symbol in this document:  
This symbol refers to important circumstances.



Symbol on the device:  
The symbol is on the housing, near the hinge.  
Direction of rotation of the rotor.



Symbol on the device:  
The symbol is located on the front of the housing, below the borehole.  
The direction of rotation of the Allen key to unlock the lid in an emergency.



Symbol on the device and in this document:  
Symbol for the separate collection of electric and electronic devices according to the guideline 2012/19/EU.



Applies in the countries of the European Union, as well as in Norway and Switzerland.



Symbol on the shipping carton label:  
This way up.



Symbol on the shipping carton label:  
The shipping packaging must be transported and handled within the indicated humidity range (10% - 80%).

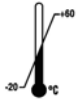

Symbol on the shipping carton label:  
The shipping packaging must be stored, transported and handled within the temperature range shown (-20°C - +60°C).



Symbol on the shipping carton label:  
The shipping packaging must be kept away from rain and kept in a dry environment.



Symbol on the shipping carton label:  
Fragile, handle with care.



Symbol on the shipping carton label:  
Stack limit. Maximum number of identical packages which may be stacked on the bottom package, whereby "n" stands for the number of permissible packages. The bottom package is not included in "n".

### 3 Intended use

This device is a medical product (laboratory centrifuge) within the context of the IVD Directive 98/79/EC.

The centrifuge is used for centrifugal separation of human blood samples in haematocrit capillaries in accordance with EN ISO 12772.

The centrifuge is only meant for this purpose.

Another use or one which goes beyond this, is considered to be non-intended. The company Andreas Hettich GmbH & Co. KG is not liable for damage resulting from this.

Observing all information in the operating instructions and complying with the measures described therein is also a part of the intended use.

If the centrifuge is installed in another device or in a system, the manufacturer of the overall system is responsible for its safety.

### 4 Remaining risks

The device is built according to the state-of-the-art and the recognized safety regulations. If used and handled improperly, there could be life-threatening danger to the user or third parties, or the device could be impaired or there could be other property damage. The device is only to be used for its intended purpose and only when it is in safe working condition.

Malfunctions which could affect safety must be corrected immediately.



## 5 Technical specifications

Manufacturer	Andreas Hettich GmbH & Co. KG D-78532 Tuttlingen	
Model	HAEMATOKRIT 200	
Type	1801	1801-01
Mains voltage ( $\pm 10\%$ )	200 - 240 V 1~	100 - 127 V 1~
Mains frequency	50 - 60 Hz-	50 - 60 Hz-
Connected load	270 VA	270 VA
Current consumption	1.3 A	2.6 A
Max. capacity	24 x 2.2 ml	
Allowed density	1.2 kg/dm <sup>3</sup>	
Speed (RPM)	13000	
Force (RCF)	16060	
Kinetic energy	950 Nm	
Obligatory inspection (DGUV Regel 100 - 500)	no	
Ambient conditions (EN / IEC 61010-1)	<p>Indoors only</p> <p>Up to 2000 m above sea level</p> <p>2°C to 40°C</p> <p>Maximum relative humidity 80% for temperatures up to 31°C, linearly decreasing to 50% relative humidity at 40°C.</p>	
– Set-up site		
– Altitude		
– Ambient temperature		
– Humidity		
– Excess-voltage category (IEC 60364-4-443)	II	
– Pollution degree	2	
Device protection class	I	
Not suitable for use in explosion-endangered areas.		
EMC		
– Emitted interference, Interference immunity	EN / IEC 61326-1, Class B	FCC Class B
Noise level (dependent on rotor)	$\leq 56$ dB(A)	
Dimensions		
– Width	261 mm	
– Depth	353 mm	
– Height	228 mm	
Weight	approx. 10 kg	

## 6 Notes on safety

 **No claim of warranty will be considered by the manufacturer unless ALL instructions in this manual have been followed.**

 **Reports of serious incidents involving the device**

Report any serious incidents involving the device to the manufacturer and, if necessary, to the competent authority.



- **The centrifuge should be installed on a good, stable base.**
- **Before using the centrifuge absolutely check the rotor for firm placement.**
- **When the centrifuge is running, according to EN / IEC 61010-2-020, no persons, dangerous substances or objects may be within the safety margin of 300 mm around the centrifuge.**
- **Rotors, suspensions and accessories that possess traces of corrosion or mechanical damage or if their term of use has expired may not be used any longer.**
- **The centrifuge may no longer be put into operation when the centrifuging chamber has safety-related damages.**
- **For centrifuges without temperature control, when the room temperature is increased and/or if the device is frequently used, the centrifuging chamber could be heated up. Therefore, it can't be ruled out that the sample material might be changed due to the temperature.**

- **Before the initial operation of your centrifuge you should read and pay attention to the operating instructions. Only personnel that has read and understood the operating instructions are allowed to operate the device.**
- Along with the operating instructions and the legal regulations on accident prevention, you should also follow the recognised professional regulations for working in a safe and professional manner. These operating instructions should be read in conjunction with any other instructions concerning accident prevention and environmental protection based on the national regulations of the country where the device is to be used.
- This centrifuge is a state-of-the-art piece of equipment which is extremely safe to operate. However, it can lead to danger for users or others if used by untrained staff, in an inappropriate way or for a purpose other than that it was designed for.
- The centrifuge must not be moved or knocked during operation.
- In case of fault or emergency release, never touch the rotor before it has stopped turning.
- To avoid damage due to condensate, when changing from a cold to a warm room the centrifuge must either heat up for at least 3 hours in the warm room before being connected to the mains, or run hot for 30 minutes in the cold room.
- Only the rotor approved by the manufacturer for this device and the approved accessories may be used (see chapter "Anhang/Appendix, Rotoren und Zubehör/Rotors and accessories"). Before centrifuge vessels are used which are not listed in the chapter "Appendix, Rotors and accessories", the user must make sure they can be used by asking the manufacturer.
- The centrifuge rotor may only be loaded in accordance with the chapter "Loading the rotor".
- When centrifuging with maxim revolutions per minute the density of the materials or the material mixtures may not exceed 1.2 kg/dm<sup>3</sup>.
- The centrifuge may only be operated when the balance is within the bounds of acceptability.
- The centrifuge may not be operated in explosion-endangered areas.
- The centrifuge must not be used with:
  - inflammable or explosive materials
  - materials that react with one another producing a lot of energy.
- If users have to centrifuge hazardous materials or compounds contaminated with toxic, radioactive or pathogenic micro-organisms, they must take appropriate measures.

For hazardous substances centrifuge containers with special screw caps must strictly be used. In addition to the screw cap centrifuge containers, for materials in hazard category 3 and 4 a biosafety system must be used (see the World Health Organisation's "Laboratory Biosafety Manual").

Without the use of a biosafety system the centrifuge is not microbiologically sealed in the sense of the EN / IEC 610101-2-020 standard.

No biosafety systems are available for this centrifuge.

- The centrifuge must not be operated with highly corrosive substances which could impair the mechanical integrity of rotors, hangers and accessories.
- Repairs must only be carried out by personnel authorised to do so by the manufacturer.
- Only original spare parts and original accessories licensed by the Andreas Hettich GmbH & Co. KG company are allowed to be utilised.
- The following safety regulations apply:  
EN / IEC 61010-1 and EN / IEC 61010-2-020 as well as their national deviations.
- The safe operation and reliability of the centrifuge can only be guaranteed if:
  - the centrifuge is operated in accordance with the operating instructions,
  - the electrical installation on the site where the centrifuge is installed conforms to the demands of EN / IEC stipulations.
- Meeting the country-specific requirements concerning occupational safety with regard to the use of laboratory centrifuges at the workplaces provided for this purpose by the user is the responsibility of the user.

## 7 Transport and storage

### 7.1 Transport



Before transporting the device, the transport securing device must be installed.

When the device and accessories are transported, the following ambient conditions must be complied with:

- Ambient temperature: -20°C to +60°C
- Relative humidity: 10% to 80%, non-condensing

### 7.2 Storage



The device and the accessories may only be stored in closed and dry rooms.

When the device and accessories are stored, the following ambient conditions must be complied with:

- Ambient temperature: -20°C to +60°C
- Relative humidity: 10% to 80%, non-condensing

## 8 Scope of delivery

The following accessories are delivered with the centrifuge:

- 1 connecting cable
- 2 fuses
- 1 hex head wrench
- 1 operating manual
- 1 information sheet, transport securing device
- 1 information sheet, emergency unlocking

The rotor(s) and associated accessories are included in the delivery in the quantity.

## 9 Removing the transport securing device



It is imperative that the transport securing device be removed.

Keep the transport securing device in a safe place since it must be installed again before transporting the device.

The device may only be transported with the transport securing device installed.

To protect the device from damage during transport, the motor is fixed in place.  
This transport securing device must be removed when the device is put into operation.

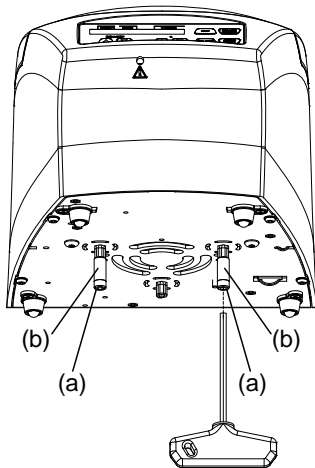

- Remove the two screws (a) and spacer sleeves (b).



The transport securing device is installed in the opposite order.

## 10 Initial operation

- A type B residual current circuit breaker must be used if the device is additionally protected with a residual current circuit breaker in the building installation. When using a different type, the residual current circuit breaker may either not switch off the unit if there is a fault on the unit, or it may switch off the unit even though there is no fault on the unit.
- Remove the transport securing device from the housing floor; see the "Removing the transport securing device" chapter.
- **Position the centrifuge in a stable and level manner in a suitable place. During set-up, the required safety margin of 300 mm around the centrifuge is to be kept according to EN / IEC 61010-2-020.**



**When the centrifuge is running, according to EN / IEC 61010-2-020, no persons, dangerous substances or objects may be within the safety margin of 300 mm around the centrifuge.**

- Ventilation openings may not be blocked.  
A distance of 300 mm must be maintained from the ventilation slots and openings of the centrifuge.
- Check whether the mains voltage tallies with the statement on the type plate.
- Connect the centrifuge with the power cord to a standard mains socket. For connection ratings refer to Chapter "Technical specifications".
- Switch on the mains switch (switch position "I").  
The following displays appear one after the other:
  1. The centrifuge model
  2. The type number and program version
  3. The last used centrifugation data



If the lid is closed, the message "Open the lid" is displayed.  
In this case, open the lid to display the centrifugation data.

## 11 Opening and closing the lid

### 11.1 Opening the lid



The lid can only be opened if the centrifuge is switched on and the rotor is stationary. If this shouldn't be possible, see the "Emergency unlock" chapter.



When the cycle counter is activated, after a centrifugation run, while opening the lid, the remaining number of running cycles (centrifugation runs) is briefly displayed.

Example:



- Press the key.  
The lid is unlocked by the motor.  
🔓 : Lid unlocked.

Example:



### 11.2 Closing the lid



Do not reach with your fingers between the lid and housing.  
Do not slam the lid closed.

- Put the lid on and lightly press the front edge of the lid down.  
The lid is locked by the motor.  
🔒 : Lid locked.

Example:



## 12 Installation and removal of the rotor

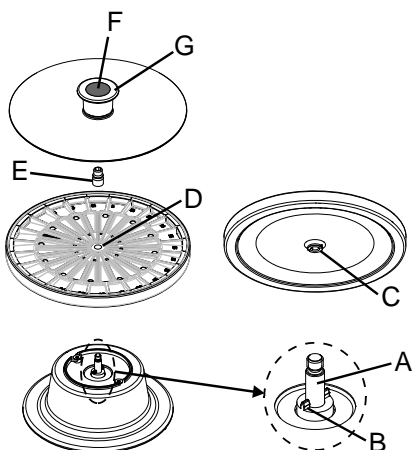

### Installation:

- Place the rotor vertically onto the motor shaft (A) and press it downwards. The motor shaft dog (B) has to fit in the rotor slot (C). The alignment of the groove is labelled on the rotor (D).
- Screw the fixing nut (E) with the supplied hex. pin driver on the motor shaft (A) by turning in a clockwise direction and tighten it.



The fixing nut (E) must always be firmly tightened to the motor shaft (A).

- Check the rotor to make sure it is seated firmly.



To ensure a tight fit of the rotor, the nut of the rotor must be hand-tightened.

- Put the lid onto the rotor and press it down at the handle as far as the lid clicks in.

### Removal:

- Press the knob (F) in the handle of the lid downwards, simultaneously pull the outer ring (G) of the handle and remove the lid from the rotor.
- Unscrew the fixing nut (E) with the supplied hex. pin driver by turning in a counter clockwise direction, and remove it.
- Lift up the rotor from the motor shaft (A).

## 13 Loading the rotor

- Check the rotor for firm seating.
- Remove the cover from the rotor:  
Press the button (F) in the handle of the cover downward, and at the same time, pull the outer ring (G) of the handle upward and remove the cover from the rotor. For figure, see the chapter "Installation and removal of the rotor".
- The rotor may only be loaded symmetrically. The centrifuge containers have to be distributed evenly on all rotor positions. For authorised combinations see Chapter "Anhang/Appendix, Rotoren und Zubehör/Rotors and accessories".

Example:

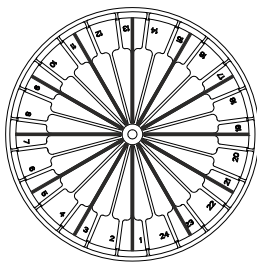

Rotor is evenly loaded

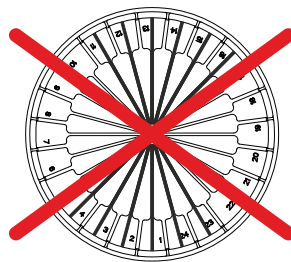

**Not permitted!**

Rotor is not evenly loaded

- For the haematocrit measurement the capillaries are always filled up to  $\approx 75\%$ .
- When loading the rotor, no liquid may enter the rotor or the centrifuging chamber.
- When using standard capillary tubes, insert these in the rotor with the lute side out.  
When using self-sealing capillary tubes, insert these in the rotor with the plug side out.
- After loading the rotor, place the cover on the rotor and press downward on the handle until the cover engages.

## 14 Operating and display elements

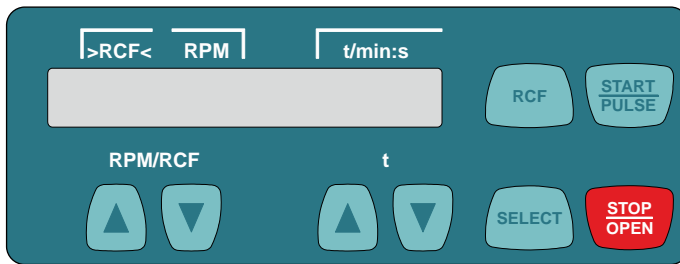

### 14.1 Displayed symbols



Lid unlocked.



Lid locked.



Rotation display. The rotation display lights up, rotating counterclockwise, as long as the rotor is turning.

### 14.2 Control panel keys

#### RPM/RCF



- Input the speed directly.
- If the key is kept pressed, the value changes with increasing speed.

#### t



- Input the runtime directly.
- Adjustable in steps of 1 second up to a minute, and in steps of 1 minute starting from 1 minute.
- Input the centrifuging parameters.
- If the key is kept pressed, the value changes with increasing speed.



- Selection key for activating the individual parameters. Every time the key is pressed, the next parameter is activated.
- Call up the "MACHINE MENU" (keep the key pressed for 8 seconds).
- In the "Machine Menu", select the menus "→ Info", "→ Settings" and "→ Time & Cycles".
- Scroll forward in the menus.



- Switching between the RPM display (RPM) and RCF display (>RCF<). RCF values are displayed in parentheses > <.
- RPM Speed
- RCF : Relative centrifugal acceleration



- Start the centrifugation run.
- Short-term centrifugation. Centrifugation is run as long as the key is kept pressed.
- Call up the menu "→ Info", "→ Settings" and "→ Time & Cycles".



- Finish the centrifugation run. The rotor runs down with a pre-selected brake stage. Pressing the key twice triggers the Emergency Stop.
- Unlock the lid.

### 14.3 Setting options

**t/min** **Runtime.** Adjustable from 1 - 99 min, in steps of 1 minute.

**t/sec** **Runtime.** Adjustable from 1 - 59 s, in steps of 1 second.

**Continuous run** "--:--". Set the parameters **t/min** and **t/sec** to zero.

**RPM** **Speed**

A number value from 200 rpm to the maximum speed of the rotor can be set. Adjustable from 200 RPM to 10000 RPM in steps of 10, and above 10000 RPM, in steps of 100. For the maximum rotor speed, see the chapter "Appendix, Rotors and accessories".

**>RCF<** **Relative centrifugal force**

A number value can be set which results in a speed between 200 rpm and the maximum rotor speed. Adjustable up to 10000 in steps of 1, and above 10000, in steps of 10.



It is only possible to input the relative centrifugal force (RCF) if the RCF display (>RCF<) is activated.

The relative centrifugal force (RCF) depends on the centrifuging radius (RAD). After entering the RCF, check to make sure that the correct centrifuging radius has been set.

**RAD/mm** **Centrifuging radius**

Adjustable from 10 mm to 250 mm, in steps of 1 mm. For the centrifuging radius, see the chapter "Appendix, Rotors and accessories".





It is only possible to input the centrifuging radius if the RCF display (>RCF<) is activated.

**~\DEC** **Brake stage.** **fast** = short run-out time, **slow** = long run-out time.



## 15 Entering centrifugation parameters

### 15.1 Direct input of the centrifugation parameters

The speed (RPM), the relative centrifugal force (RCF), the centrifuging radius (RAD) and the runtime can be input directly with the keys   without previously having to press the  key.

 The set centrifugation parameters are only stored after starting the centrifugation run.

#### 15.1.1 Speed (RPM)



- Press the key to activate the RPM display (RPM) as needed.

Example:



- Set the desired value with the keys.



#### 15.1.2 Relative centrifugal force (RCF) and centrifugal radius (RAD)



- Press the key to activate the RCF display (>RCF<) as needed.

Example:

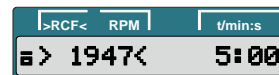

- Set the desired RCF value with the keys.

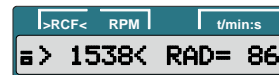

- Set the desired centrifuging radius with the keys as needed.

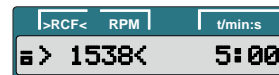
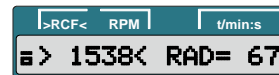

#### 15.1.3 Runtime

 Up to 1 minute, the runtime can be set in steps of 1 second, and starting from 1 minute, it can only be set in steps of 1 minute.

In order to set the continuous run, the parameters **t/min** and **t/sec** must be set to zero. In the time display (t/min:s), "--:--" appears.

Example:

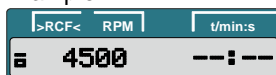

Example:



- Set the desired value with the keys.



15.2 Input of the centrifugation parameters with the "SELECT" key



The runtime can be set in minutes and seconds (parameters **t/min** and **t/sec**).

In order to set the continuous run, the parameters **t/min** and **t/sec** must be set to zero. In the time display (t/min:s), "--:--" appears.

Example:





The relative centrifugal acceleration (RCF) depends on the centrifuging radius (RAD).

During the input of the RCF, the set centrifuging radius is displayed.

If no key is pressed for 8 seconds after selection or during parameter input, the previous values are shown on the display. The parameters must then be input again.







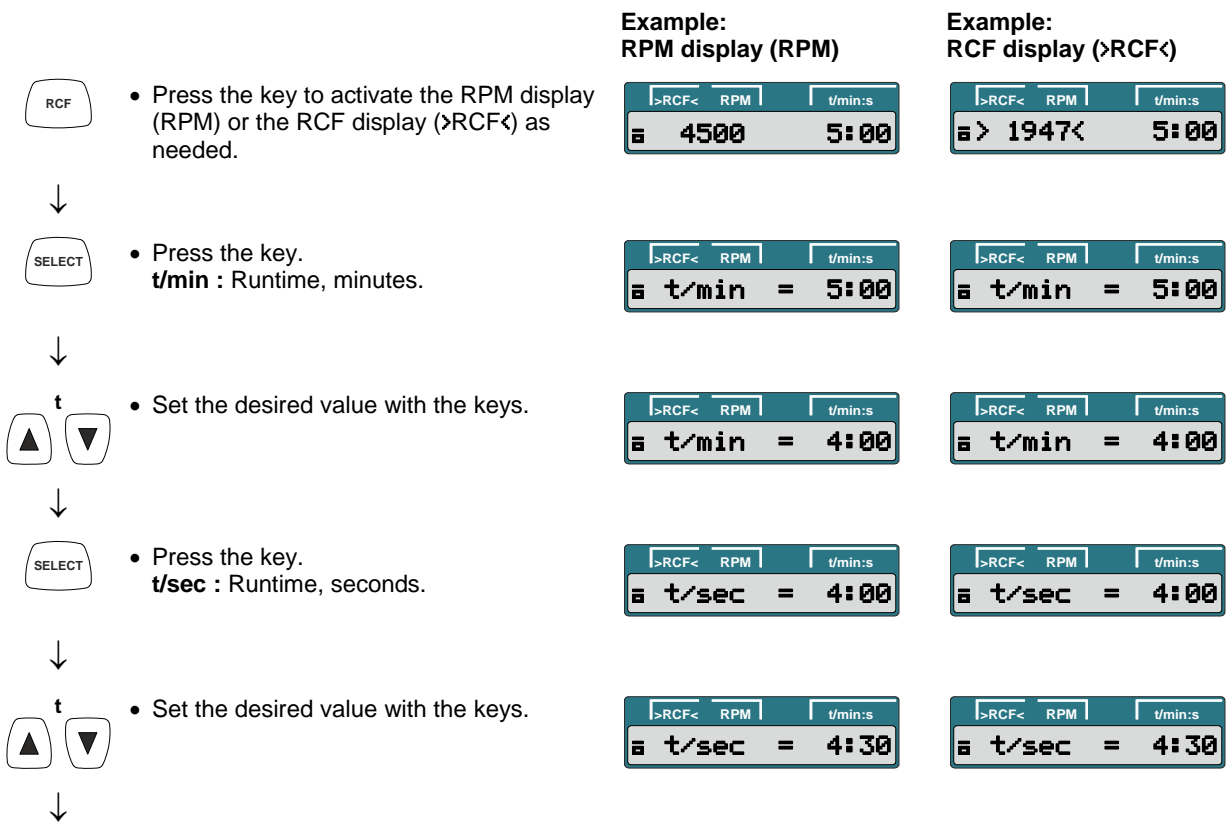



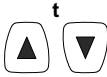
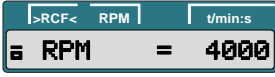

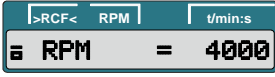

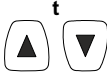

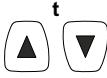

By pressing the  button, the settings will be saved.

If several parameters are input, the  key must be pressed after setting the last parameter.

Entering parameters can be cancelled at any time by pressing the  key. In this case, the settings are not stored.



Continued on next page

	<ul style="list-style-type: none"> <li>• Press the key.  <b>RPM</b> : Speed.  <b>RAD/mm</b> : Centrifuging radius.                      It is only possible to display and input the centrifuging radius if the RCF display (&gt;RCF&lt;) is activated.</li> </ul>	<b>Example: RPM display (RPM)</b>	<b>Example: RCF display (&gt;RCF&lt;)</b>
	<ul style="list-style-type: none"> <li>• Set the desired value with the keys.</li> </ul>		
	<ul style="list-style-type: none"> <li>• Press the key.  <b>R</b> : Centrifuging radius.  <b>RCF</b> : Relative centrifugal force</li> </ul>		
	<ul style="list-style-type: none"> <li>• Set the desired value with the keys.</li> </ul>		
	<ul style="list-style-type: none"> <li>• Press the key.  <math>\sim</math>DEC : Brake stage.  <b>fast</b> : short run-out time.  <b>slow</b> : long run-out time.</li> </ul>		
	<ul style="list-style-type: none"> <li>• Set the desired value with the keys.</li> </ul>		
	<ul style="list-style-type: none"> <li>• Press the button to save the settings.</li> </ul>		
			

## 16 Centrifugation

 In accordance with EN / IEC 61010-2-020, no persons, hazardous substances or objects may be within a safety range 300 mm around the centrifuge during a centrifugation run.

 If the permissible weight difference was exceeded within the rotor load, the centrifugation run is aborted during start-up and the following will appear on the display:



A centrifugation run can be aborted at any time by pressing the  key.

During a centrifugation run, centrifugation parameters can be selected and changed. The changed values, however, only apply to the current centrifugation run and are not saved.

With the  key, you can toggle between the RPM display (RPM) and RCF display (>RCF<) at any time. If the RCF display (>RCF<) is worked with, the centrifuging radius must be input.

The following is displayed:



Further operation of the centrifuge is then only possible after opening the lid.

Operation errors and malfunctions will be shown (see the chapter on "Malfunctions").

- Switch on the mains switch. Switch position I.
- Load the rotor and close the centrifuge lid.

### 16.1 Centrifugation with preset time

- Press the  key to activate the RPM display (RPM) or the RCF display (>RCF<) as needed.

**Example:  
RPM display (RPM)**

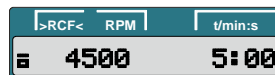

**Example:  
RCF display (>RCF<)**

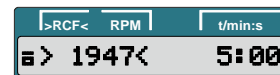

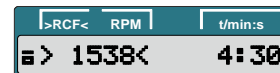
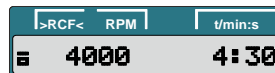

- Enter the desired centrifugation parameters (see the chapter "Entering centrifugation parameters").



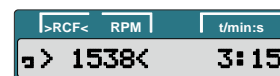
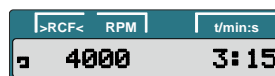





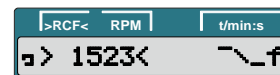
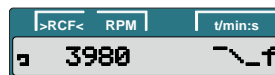



- Press the  key to start the centrifugation run.  
During the centrifugation run, the rotor speed or the resulting RCF value and remaining time are displayed.



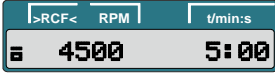

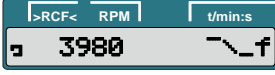

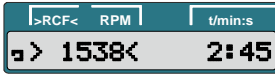





- After the time elapses or if the centrifugation run is aborted by pressing the  key, the run-out occurs with the set brake stage. The brake stage is displayed. Example 

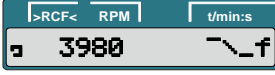

### 16.2 Continuous run

<p></p> <ul style="list-style-type: none"> <li>Press the key to activate the RPM display (RPM) or the RCF display (&gt;RCF&lt;) as needed.</li> </ul> <p>↓</p> <ul style="list-style-type: none"> <li>Input the desired centrifugation parameters. Set the parameters <b>t/min</b> and <b>t/sec</b> to zero (see the chapter "Entering centrifugation parameters").</li> </ul> <p>↓</p> <p></p> <ul style="list-style-type: none"> <li>Press the key to start the centrifugation run. During the centrifugation run, the rotor speed or the resulting RCF value and elapsed time are displayed.</li> </ul> <p>↓</p> <p></p> <ul style="list-style-type: none"> <li>Press the key to end the centrifugation run. The run-out occurs with the set brake stage. The brake stage is displayed. Example </li> </ul>	<p><b>Example: RPM display (RPM)</b></p>    	<p><b>Example: RCF display (&gt;RCF&lt;)</b></p>    
--	---	---

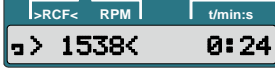
### 16.3 Short-term centrifugation

<p></p> <ul style="list-style-type: none"> <li>Press the key to activate the RPM display (RPM) or the RCF display (&gt;RCF&lt;) as needed.</li> </ul> <p>↓</p> <ul style="list-style-type: none"> <li>Enter the desired centrifugation parameters (see the chapter "Entering centrifugation parameters").</li> </ul> <p>↓</p> <p></p> <ul style="list-style-type: none"> <li>Press the key and keep it pressed. During the centrifugation run, the rotor speed or the resulting RCF value and elapsed time are displayed.</li> </ul> <p>↓</p> <p></p> <ul style="list-style-type: none"> <li>Release the key again to end the centrifugation run. The run-out occurs with the set brake stage. The brake stage is displayed. Example </li> </ul>	<p><b>Example: RPM display (RPM)</b></p>    	<p><b>Example: RCF display (&gt;RCF&lt;)</b></p>    
--	---	---

## 17 Emergency Stop



- Press the key twice.  
During the Emergency Stop, the run-out occurs with the "fast" brake stage (short run-out time). Brake stage `~_f` is displayed.

### Example: RPM display (RPM)



### Example: RCF display (>RCF<)



## 18 Settings and queries

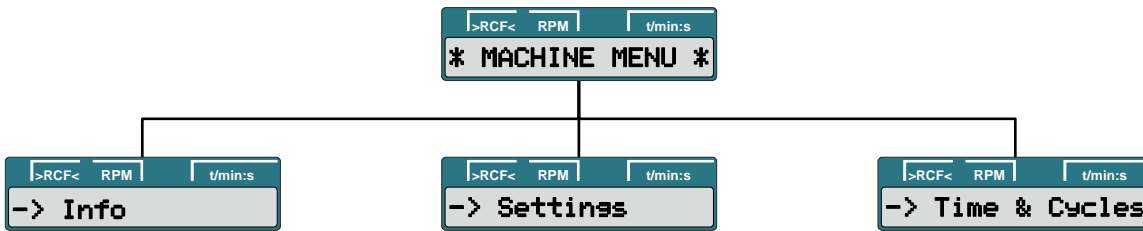

### Query:

- System information

### Setting:

- Acoustic signal
- Automatic unlocking of the lid after the centrifugation run
- Automatic switch-off of the background lighting
- Optical signal after ending the centrifugation run

### Query:



- Hours of operation
- Number of completed centrifugation runs

### 18.1 Querying system information

The following system information can be queried:

- Device model,
- Program version of the device,
- Type number of the device,
- Device date of manufacture,
- Device serial number,
- Frequency converter type
- Frequency converter program version

With the rotor at a standstill, the query can proceed as follows:

 The procedure can be aborted at any time by pressing the  key.



- Press and hold the button for eight seconds.



- Press the key.



- Press the key.  
Device model.



- Press the key.  
Program version of the device.

Example:



- Press the key.  
**Type#1** : Type number of the device.

Example:

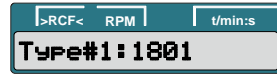

- Press the key.  
**Type#2** : Continuation of the type number if this has more positions than the "Type#1" display field.

Example:



- Press the key.  
Device date of manufacture.

Example:



Continued on next page



- Press the key.  
Device serial number.

Example:



- Press the key.  
Frequency converter type.

Example:



- Press the key.  
Frequency converter program version.

Example:

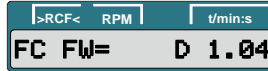

- Press the key twice to exit the "-> Info" menu or press three times to exit the "\* MACHINE MENU \*".



Example:







## 18.2 Acoustic signal

The acoustic signal sounds:

- after a malfunction occurs in a 2-second interval.
- after ending the centrifugation run and the rotor is at a standstill in a 30-second interval.

The acoustic signal is ended by pressing any key.

If the rotor is at a standstill, the acoustic signal can be set as follows:

 The procedure can be aborted at any time by pressing the  key. In this case, the settings are not stored.

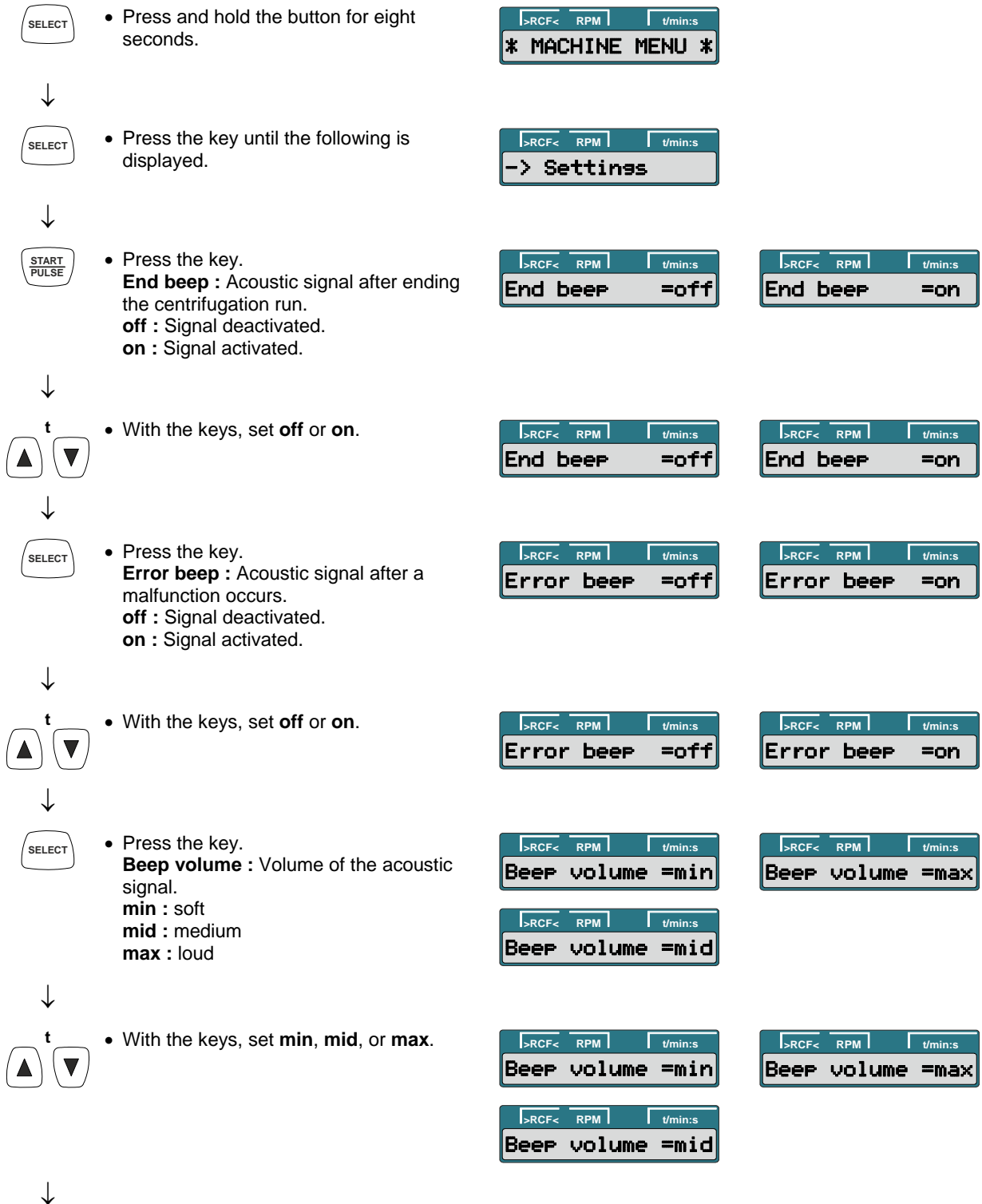

Continued on next page



- Press the button to save the setting.



- Press the key once to exit the "-> Settings" menu or press twice to exit the "\* MACHINE MENU \*".



Example:

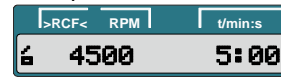

### 18.3 Optical signal after ending the centrifugation run

The backlighting of the display flashes after the centrifugation run to visually signalize that the centrifugation run has finished.

The optical signal can be switched on or off when the rotor is at a standstill:

The procedure can be aborted at any time by pressing the key.



- Press and hold the button for eight seconds.



- Press the key until the following is displayed.



- Press the key.



- Press the key until one of the following is displayed:  
**End blinking** : Backlighting of display flashes after the centrifugation run.  
**off** : Backlighting does not flash.  
**on** : Backlighting flashes.



- With the keys, set **off** or **on**.



- Press the button to save the setting.



- Press the key once to exit the "-> Settings" menu or press twice to exit the "\* MACHINE MENU \*".



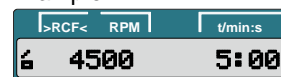

Example:



















### 18.4 Automatic unlocking of the lid after the centrifugation run

It can be set whether the lid should automatically unlock or not after the centrifugation run.

With the rotor at a standstill, this can be set as follows:

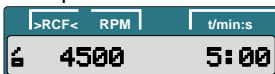

 The procedure can be aborted at any time by pressing the  key. In this case, the settings are not stored.



















	<ul style="list-style-type: none"> <li>Press and hold the button for eight seconds.</li> </ul>		
↓			
	<ul style="list-style-type: none"> <li>Press the key until the following is displayed.</li> </ul>		
↓			
	<ul style="list-style-type: none"> <li>Press the key.</li> </ul>		
↓			
	<ul style="list-style-type: none"> <li>Press the key until one of the following is displayed:  <b>Lid AutoOpen</b> : Automatic unlocking of the lid after the centrifugation run.  <b>off</b> : Lid does not unlock automatically.  <b>on</b> : Lid unlocks automatically.</li> </ul>		
↓			
	<ul style="list-style-type: none"> <li>With the keys, set <b>off</b> or <b>on</b>.</li> </ul>		
↓			
	<ul style="list-style-type: none"> <li>Press the button to save the setting.</li> </ul>		
↓			
	<ul style="list-style-type: none"> <li>Press the key once to exit the "-&gt; Settings" menu or press twice to exit the "* MACHINE MENU *".</li> </ul>		<p>Example:</p> 

### 18.5 Backlighting of the display

To save energy, it can be set that, after a centrifugation run, the backlighting of the display switches off after 2 minutes.

With the rotor at a standstill, this can be set as follows:

 The procedure can be aborted at any time by pressing the  key. In this case, the settings are not stored.

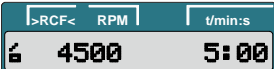
	<ul style="list-style-type: none"> <li>Press and hold the button for eight seconds.</li> </ul>			
↓		<ul style="list-style-type: none"> <li>Press the key until the following is displayed.</li> </ul>		
↓		<ul style="list-style-type: none"> <li>Press the key.</li> </ul>		
↓		<ul style="list-style-type: none"> <li>Press the key until one of the following is displayed:  <b>Power save</b> : Automatic shutdown of the backlighting.  <b>off</b> : Automatic shutdown deactivated.  <b>on</b> : Automatic shutdown activated.</li> </ul>		
↓		<ul style="list-style-type: none"> <li>With the keys, set <b>off</b> or <b>on</b>.</li> </ul>		
↓		<ul style="list-style-type: none"> <li>Press the button to save the setting.</li> </ul>		
↓		<ul style="list-style-type: none"> <li>Press the key once to exit the "-&gt; Settings" menu or press twice to exit the "* MACHINE MENU *".</li> </ul>		<p>Example:</p> 



### 18.6 Querying the hours of operation and the number of centrifugation runs

The hours of operation are divided into internal and external hours of operation.

Internal hours of operation: Total time the device was switched on.

External hours of operation: Total time of the previous centrifugation runs.

With the rotor at a standstill, the query can proceed as follows:

 The procedure can be aborted at any time by pressing the  key.



- Press and hold the button for eight seconds.



- Press the key until the following is displayed.



- Press the key.  
**TimeExt** : External hours of operation.

Example:



- Press the key.  
**TimeInt** : Internal hours of operation.

Example:



- Press the key.  
**Starts** : Number of all centrifugation runs.

Example:



- Press the key twice to exit the "-> Time & Cycles" menu or press three times to exit the "\* MACHINE MENU \*".



Example:



## 19 Relative centrifugal force (RCF)

The relative centrifugal force (RCF) is given as a multiple of the acceleration of gravity (g). It is a unit-free value and serves to compare the separation and sedimentation performance.

These values are calculated using the formula below:

$$\text{RCF} = \left( \frac{\text{RPM}}{1000} \right)^2 \times r \times 1,118 \quad \Rightarrow \quad \text{RPM} = \sqrt{\frac{\text{RCF}}{r \times 1,118}} \times 1000$$

RCF = relative centrifugal force

RPM = rotational speed (revolutions per minute)

r = centrifugal radius in mm = distance from the centre of the turning axis to the bottom of the centrifuge container. For more on the centrifugal radius see the chapter "Anhang/Appendix, Rotoren und Zubehör/Rotors and accessories".



The relative centrifugal force (RCF) stands in relation to the revolutions per minute and the centrifugal radius.

## 20 Centrifugation of materials or mixtures of materials with a density higher than 1.2 kg/dm<sup>3</sup>

When centrifuging with maximum revolutions per minute the density of the materials or the material mixtures may not exceed 1.2 kg/dm<sup>3</sup>.

The speed must be reduced for materials or mixtures of materials with a higher density.

The permissible speed can be calculated using the following formula:

$$\text{Reduced speed (n}_{\text{red}}) = \sqrt{\frac{1.2}{\text{Greater density [kg/dm}^3]}} \times \text{maximum speed [RPM]}$$

e.g.: maximum speed RPM 4000, density 1.6 kg/dm<sup>3</sup>

$$n_{\text{red}} = \sqrt{\frac{1.2 \text{ kg/dm}^3}{1.6 \text{ kg/dm}^3}} \times 4000 \text{ RPM} = 3464 \text{ RPM}$$

If in doubt you should obtain clarification from the manufacturer.

**PRAXISDIENST**  
Medical Supplies since 1953

**Order here!**

## 21 Haematocrit measurement

### 21.1 Determining the centrifugation time

To determine the centrifugation time, the following approximation formula applies:

$$\frac{100000}{\text{RCF}} = \text{centrifugation time in minutes}$$

RCF = Relative centrifugal acceleration

To calculate the RCF, see the chapter "Relative centrifugal acceleration (RCF)".

Example:

$$\text{RCF} = 16060$$

$$\frac{100000}{16060} = 6.23 \text{ minutes} = 6 \text{ minutes and } 14 \text{ seconds}$$

For a RCF of 16060, the centrifugation time is 6 minutes and 14 seconds.

### 21.2 Reading off the hematocrit value

The hematocrit value is read off as follows:

- Hold onto the rotor.
- Turn the evaluation disk (rotor cover) until the 100% line of the evaluation disk is aligned with the top edge of the fluid column in the capillary tube.
- Read off the hematocrit value at the top edge of the erythrocyte column.

Repeat this procedure until all capillary tubes have been evaluated.

## 22 Emergency unlocking

In the event of a power failure, the lid cannot be unlocked with the motor. Emergency unlocking must be done by hand.



To unlock in an emergency, disconnect the centrifuge from the mains.  
Open the lid only when the rotor is at a standstill.



CAUTION! Damage to the lock during emergency unlocking by turning the hexagon Allen key in clockwise direction (to the right).

The Allen key may only be turned counter clockwise (to the left); see figure.

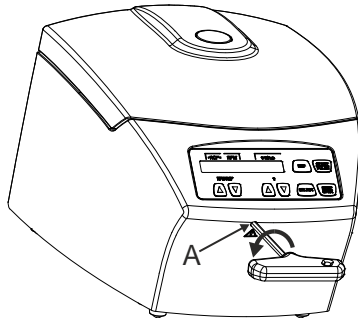

- Switch off the mains switch (switch setting "0").
- Look through the window in the lid to make sure that the rotor is at a standstill.
- Insert the Allen key horizontally in the bore (A) and turn carefully counter clockwise (to the left) until the lid opens.
- Pull the Allen key back out of the bore.

## 23 Maintenance and servicing



The device can be contaminated.



Pull the mains plug before cleaning.

Before any other cleaning or decontamination process other than that recommended by the manufacturer is applied, the user has to check with the manufacturer that the planned process does not damage the device.

- Centrifuges, rotors and accessories must not be cleaned in rinsing machines.
- They may only be cleaned by hand and disinfected with liquids.
- The water temperature must be between 20 – 25°C.
- Only detergents/disinfectants may be used which:
  - have a pH between 5 - 8
  - do not contain caustic alkalis, peroxides, chlorine compounds, acids and alkaline solutions
- In order to prevent appearances of corrosion through cleaning agents or disinfectants, the application guide from the manufacturer of the cleaning agent or disinfectant are absolutely to be heeded.



Haematocrit rotor, rotor lid, padded shells, and sealing rings are not autoclavable.

## 23.1 Centrifuge (housing, lid and centrifuging chamber)

### 23.1.1 Surface cleaning and care

- Clean the centrifuge housing and the centrifuging chamber regularly, using soap or a mild detergent and a damp cloth if required. For one thing, this services purposes of hygiene, and it also prevents corrosion through adhering impurities.
- Ingredients of suitable detergents: soap, anionic tensides, non-ionic tensides.
- After using detergents, remove the detergent residue by wiping with a damp cloth.
- The surfaces must be dried immediately after cleaning.
- In the event of condensation water formation, dry the centrifugal chamber by wiping out with an absorbent cloth.
- Lightly rub the rubber seal of the centrifuge chamber with a rubber care product after each cleaning.
- The centrifuging chamber is to be checked for damage once a year.



If damage is found which is relevant to safety, the centrifuge may no longer be put into operation. In this case, notify Customer Service.

### 23.1.2 Surface disinfection

- If infectious materials penetrates into the centrifugal chamber this is to be disinfected immediately.
- Ingredients of suitable disinfectants: ethanol, n-propanol, ethyl hexanol, anionic tensides, corrosion inhibitors.
- After using disinfectants, remove the disinfectant residue by wiping with a damp cloth.
- The surfaces must be dried immediately after disinfecting.

### 23.1.3 Removal of radioactive contaminants

- The agent must be specifically labelled as being an agent for removing radioactive contaminants.
- Ingredients of suitable agents for removing radioactive contaminants: anionic tensides, non-ionic tensides, polyhydrated ethanol.
- After removing the radioactive contaminants, remove the agent residue by wiping with a damp cloth.
- The surfaces must be dried directly after removing the radioactive contaminants.

## 23.2 Cleaning and disinfecting the haematocrit rotor

If despite all precautions a leakage of haematocrit capillaries during centrifugation should occur, rotor and lid must be cleaned according to the following instructions:

- Carefully remove padded shells or sealing ring from the haematocrit rotor.
- Soak haematocrit rotor, lid and padded shells or sealing ring in cold water, until the blood residues are completely dissolved.
- Perform a suitable disinfection. The application of disinfection substances on the lid is to be avoided as the inscription can dissolve.  
Ingredients of suitable disinfectants: glutaraldehyde, propanol, ethyl hexanol, anionic tensides, corrosion inhibitors.  
Ingredients of suitable agents for removing radioactive contaminants: anionic tensides, non-ionic tensides, polyhydrated ethanol.
- Rinse the components in cold water and dry them.
- They can now be replaced into the centrifuge.



### 23.3 Procedure in case of broken haematocrit capillaries



Risk of injury!

Best work with two pairs of gloves worn on top of each other. Wear safety goggles and mask, as glass splinters could be blown off!

- Carefully remove lid of haematocrit rotor.
- Remove larger pieces of broken capillaries using pincers.
- Remove rotor. Carefully and slowly remove the affected padded shells or the sealing ring with pincers and exchange them.
- Clean and disinfect as described above.

#### 23.3.1 Rotors and accessories with limited service lives

The rotor (order no. 2076) can only be used for a limited time.

The expiration date can be seen on the rotor, e.g.: "einsetzbar bis Ende: IV. Quartal 2019 / usable until end of: IV. Quartal 2019" (4th quarter 2019).



For safety reasons, the rotor may no longer be used once the expiration date marked on it has been reached.

## 24 Faults



If the fault cannot be eliminated with the help of the fault table, please inform Customer Service.

Please specify the type of centrifuge and the serial number. Both numbers can be found on the name plate of the centrifuge.



Perform a MAINS RESET:

- Switch off the mains switch (switch position "0").
- Wait at least 10 seconds and then switch on the mains switch again (switch position "I").

Message / fault		Cause	Remedy
No display		No voltage Mains input fuses defective.	<ul style="list-style-type: none"> <li>- Check distribution voltage.</li> <li>- Check mains power input fuse, refer to Chapter "Change mains input fuse".</li> <li>- Mains switch ON.</li> </ul>
IMBALANCE		The rotor is unevenly loaded.	<ul style="list-style-type: none"> <li>- Open the lid after the rotor is at a standstill.</li> <li>- Check the loading of the rotor, see chapter "Loading the rotor".</li> <li>- Repeat the centrifugation run.</li> </ul>
MAINS INTER	11	Power failure during the centrifugation run. (The centrifugation run was not finished.)	<ul style="list-style-type: none"> <li>- Open the lid after the rotor is at a standstill.</li> <li>- Push  button.</li> <li>- Repeat the centrifugation run if necessary.</li> </ul>
MAINS INTERRUPT			
TACHO ERROR	1, 2	Failure of speed impulses during operation.	<ul style="list-style-type: none"> <li>- Perform a MAINS RESET when the rotor has been stationary.</li> </ul>
LID ERROR	4.1 – 4.127	Error in lid locking or lid closure.	
OVER SPEED	5	Rotation too fast	
VERSION ERROR	12	Incorrect centrifuge model recognized. Error / defect electronics	
UNDER SPEED	13	Rotation too slow	
CTRL ERROR	22.1, 25.2	Error / defect electronics	<ul style="list-style-type: none"> <li>- The device may not be switched off as long as the rotation display  is lit up and rotating. Wait until the symbol  (lid locked) is displayed (after approx. 120 seconds). Afterwards, carry out a MAINS RESET.</li> </ul>
CRC ERROR	27.1		
COM ERROR	31 – 36		
FC ERROR	60, 61.1 – 61.21, 61.64 – 61.142		
FC ERROR	61.23		
TACHO ERR	61.22	Speed measurement error	
FC ERROR	61.153	Error / defect electronics	<ul style="list-style-type: none"> <li>- Perform a MAINS RESET.</li> <li>- Check the loading of the rotor, see chapter "Loading the rotor".</li> <li>- Repeat the centrifugation run.</li> </ul>

## 25 Change mains input fuses



Switch off the mains switch and separate the device from the mains!

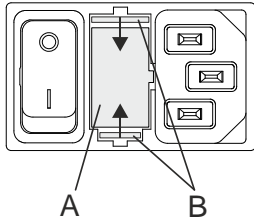

The fuse holder (A) with the mains input fuses is located next to the mains switch.

- Remove the connecting cable from the machine plug socket.
- Press the snap-fit (B) against the fuse holder (A) and remove.
- Exchange defective mains input fuses.



Only use fuses with the rating defined for the type. See the following table.

- Reinsert the fuse holder until the snap-fit clicks shut.
- Reconnect the device to the mains supply.

Model	Type	Fuse	Order no.
HAEMATOKRIT 200	1801	T 3,15 AH/250V	E997
HAEMATOKRIT 200	1801-01	T 6,3 AH/250V	2266

## 26 Returning Devices



Before returning the device, a transport securing device has to be installed.

If the device or its accessories are returned to Andreas Hettich GmbH & Co. KG, in order to provide protection for people, the environment and materials, it has to be decontaminated and cleaned before being shipped.

We reserve the right to refuse contaminated devices or accessories.

Costs incurred for cleaning and disinfection are to be charged to the customer.

We ask for your understanding in this matter.

## 27 Disposal

**The device can be disposed of via the manufacturer.**

A Return Material Authorisation (RMA) form must always be requested for a return.

If necessary, contact the Technical Service Department of the manufacturer:

Andreas Hettich GmbH & Co. KG

Föhrenstrasse 12

78532 Tuttlingen, Germany

Phone: +49 7461 705 1400

Email: [service@hettichlab.com](mailto:service@hettichlab.com)

Disposal costs may be incurred.

**WARNING****Risk of pollution and contamination for people and the environment.**

When disposing of the centrifuge, people and the environment may be polluted or contaminated by incorrect or improper disposal.

- Removal and disposal may be carried out only by a trained and authorized service personnel.

The device is intended for the commercial sector ("Business to Business" - B2B).

According to Directive 2012/19/EU, the devices may no longer be disposed of with household waste.

The appliances are assigned to the following groups according to the Stiftung Elektro-Altgeräte Register (EAR (German foundation under civil law)):

- Group 5 (small appliances)



The crossed-out bin symbol indicates that the device must not be disposed of with household waste.

Regulations governing disposal of such devices may differ in individual countries. If necessary, contact the supplier.

