

NEUATION



iROLL DR24

PRODUCT USER MANUAL

CONTENTS

1. Product Description	1
2. Safety Precautions	2
3. Installation	3
4. Standard Part Listing	4
5. User Interface and Display	5
6. Removing & Installing Disc Plate	5
7. Operation	7
8. Removal of Tubes from Disc Plate	11
9. Maintenance & Cleaning	11
10. Warranty Statement	11
11. Product Disposal	12

1. PRODUCT DESCRIPTION

1.1 INTRODUCTION

This digital disc rotator is equipped with a long life BLDC motor with a small footprint. The rotating motion provides gentle rocking and offers pulse function for thorough mixing. Set up to 9 user-defined programs with the digital display for the accurate and easy setting. The removable disc plate can be set to suit tubes of different diameters. The disc plate can be easily removed and replaced for cleaning.

1.2 INTENDED USE

This disc rotator is used in laboratories for mixing blood samples, viscous samples and for liquid-solid suspensions.

NOTE: Before using the instrument, please read this user manual carefully. This user manual is intended to assist with the operation and care of the unit only and not its repair. For repair please contact the supplier.

1.3 SYMBOL

 Warning	 Waste electrical
--	--

1.4 STANDARD ACCESSORIES

- Power Adaptor
- Product user manual & warranty card

1.5 FEATURES

- Gentle rotating motion for optimum mixing
- Adjustable speed ranging from 10 to 80 RPM
- Timer ranging from 1 min to 99 mins and infinite mode
- Maintenance free brushless DC motor for quiet operation and long life
- Removable disc Plate for proper cleaning & better contamination protection
- Optional disc plates can be chosen to hold different diameter tubes
- Pulse mode function for alternating clockwise and anticlockwise motion with 2 sec stops for better and thorough mixing
- Option for Auto power On in case of power failure - on resumption it will start automatically and run for the remaining time
- Digital display for easy setting of values
- Small footprint with the best use of lab space
- Suitable for mixing blood samples and viscous substances
- Closed loop operation for exact speed control under varied load conditions
- Low voltage instrument of 24VDC
- Works with 80% humidity and 40 °C

1. PRODUCT DESCRIPTION

1.6 TECHNICAL SPECIFICATIONS

Motor Type	Brushless DC
Motion Type	Rotating
Speed Range	10 to 80 RPM
Speed Accuracy	±1 RPM
Speed steps	±1 RPM
Timer range	0 to 99 mins & infinite mode
Disc Angle	Flexible - Can be adjusted 0 to 90°
Max Loading Capacity	2 kg
Removable Disc plate	Yes
Dimensions (mm)	395 x 336 x 326
Protection class	IP 21
Permissible Ambient Temp	5°C to 40 °C
Permissible Relative Humidity	≤80%
Weight	4.5 Kg
Altitude	Use upto an altitude of 2000 m above MSL
Pollution Degree	2
Environment	For indoor use only
Power Adaptor Details	Input: 100 - 240 VAC, 50 / 60 Hz Output: 24V --- 1.5A
Power Consumption	4.5 W

2. SAFETY PRECAUTIONS



Read all safety & usage information provided in this manual carefully before using the device.

- Never use the instrument in any manner not specified in this manual.
- Equipment used in any manner not specified in this manual or by the manufacturer might result in the lapse of warranty.
- Do not try to stop the disc plate by blocking/holding it. Do not attempt to remove disc plate during operation.
- Never move the instrument while the equipment is under operation.
- Repairs must only be performed by an authorized service technician.
- Only use recommended original spare parts for best result & product safety.
- If liquids are spilled on the disc plate, the instrument must be cleaned carefully and properly before being used again.
- Prior to mixing, the tubes should be visually inspected for material damage. Damaged tubes must not be used as this can result in sample loss and the contamination of the product.
- The maximum capacity of 2 kg must not be exceeded.

2. SAFETY PRECAUTIONS

- This product must be used for specified applications only. It must not be operated in a hazardous or flammable environment and must not be used to mix explosive or highly reactive substances.
- Do not place the potentially hazardous material within the clearance area/envelope.
- Wear your personal protective equipment in accordance with the hazards category of the medium to be processed. There is risk of liquid splashing.
- Place the instrument on a flat, leveled and solid surface. Make sure the feet of the instrument are clean and undamaged.
- Load the tubes safely and evenly. Always distribute the samples evenly on the device.
- Do not move the instrument while it is operating or connected to the main power supply.
- Ensure that the knob is firmly tightened before performing any operation.
- Ensure that only closed tubes are used for mixing.
- Do not lean on the equipment. It may damage the equipment or harm the operator.
- Do not fill tubes near the device. Liquid spillage may harm the device.
- In the event of contamination caused by aggressive agents, the device must be cleaned immediately using a natural cleaning liquid. If any damage is seen, contact the service technician.
- The power adaptor given with the unit is designed to be used for this particular unit. Do not use any other power adaptor.
- Only process media which will not react dangerously to the extra energy produced by mixing.
- Do not operate the appliance in the explosive atmosphere with hazardous substance or under water.

3. INSTALLATION

Gently remove the upper packaging and take out the disc rotator by holding it from the bottom. When this equipment is used for the first time, ensure that all the packaging accessories are removed from the product. Please keep all the packaging in safe storage for at least 2 years for warranty purposes.

3.1 LOCATION & MOUNTING

Place the device on a flat and leveled surface and ensure that all four feet stand on the surface firmly. Avoid installing on a slippery surface or surface prone to vibration.

1. Ideal ambient temperature is $20^{\circ}\text{C} \pm 5^{\circ}\text{C}$; avoid placing the device in direct sunlight.
2. Keep clearance of at least 30 cm from all sides to guarantee cooling efficiency.

3. INSTALLATION

3. Keep this away from heat or water to avoid sample temperature issues.
4. Do not place the device in such a place that it becomes difficult to operate.

3.2 CONNECTING THE POWER ADAPTOR

1. Connect one side of the power adaptor to the rear side of device and other to the power supply as shown in the figure below.
2. Ensure the power switch is OFF while connecting the power adaptor.

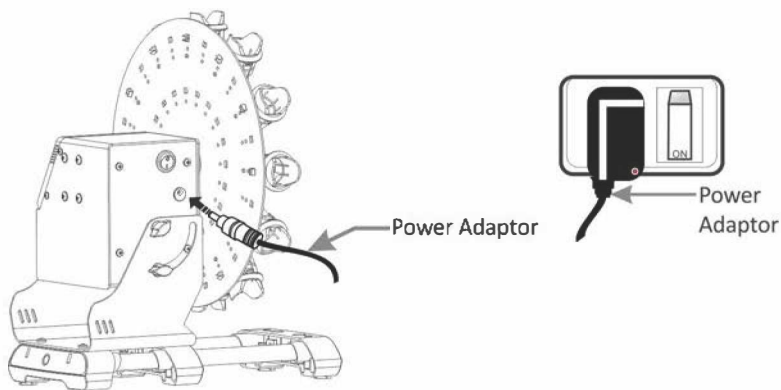

4. STANDARD PART LISTING

Front Side

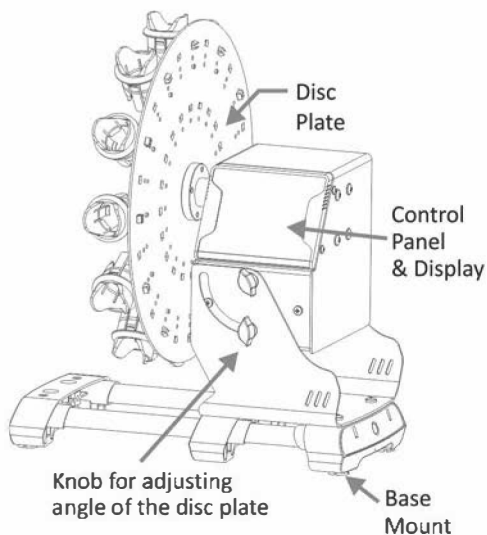

Back Side

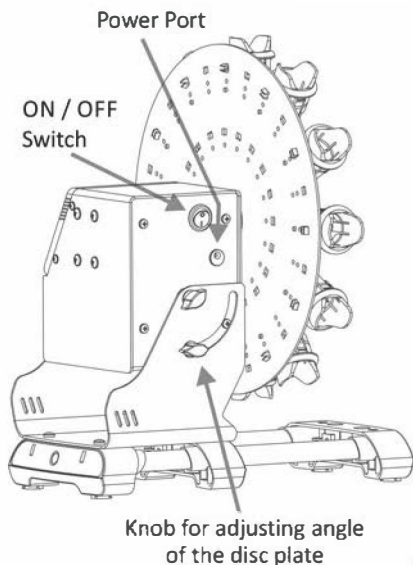

5. USER INTERFACE & DISPLAY

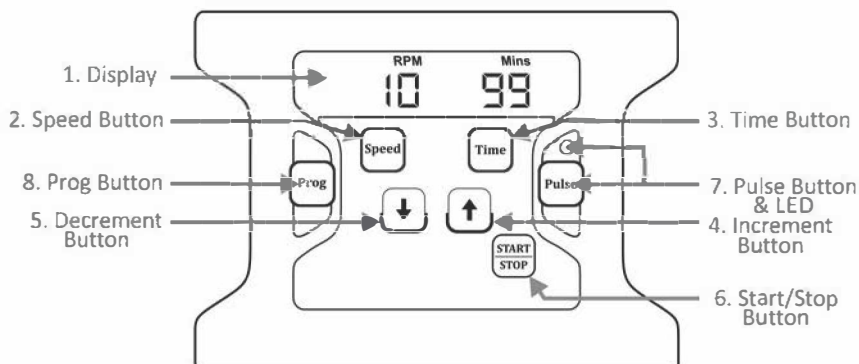

No.	Description
1. Display	The display shows the set speed as well as the time value. It also displays selected Program when in Prog Mode
2. Speed	Press 'Speed' to select speed value and use increment or decrement button to set require speed
3. Time	Press 'Time' to select time value and use increment or decrement button to set require run time
4 / 5. Increment / Decrement	Press ' Increment / Decrement ' to set require value of speed, time or program (Prog Mode)
6. Start/Stop	Press " Start/Stop " to start the operation or to stop the ongoing operation.
7. Pulse & LED	Press 'Pulse' once to start pulse operation and press it again to stop operation. Pulse LED will glow to indicate Pulse is activated.
8. Prog	Hold down 'Prog" to enter in program mode and use other require buttons to set parameter for selected program.

6. REMOVING & INSTALLING DISC PLATE

6.1 REMOVING DISC PLATE

Disc plate can be removed / changed by turning the knob in counter clockwise direction. Turn the knob in counter clockwise direction and then remove the disc plate as shown in the below representational image :

6. REMOVING & INSTALLING DISC PLATE

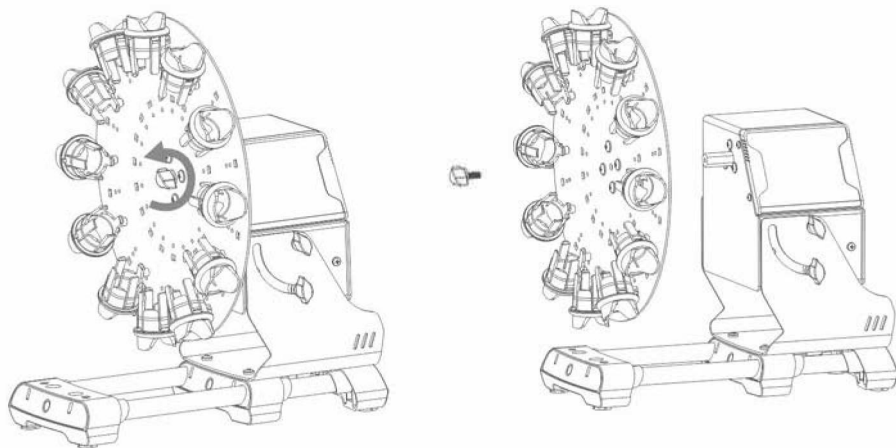

6.2 INSTALLING DISC PLATE

Follow the exact reverse process to insert back the disc plate. Below image shows the step by step procedure to insert the disc plate back into the unit.

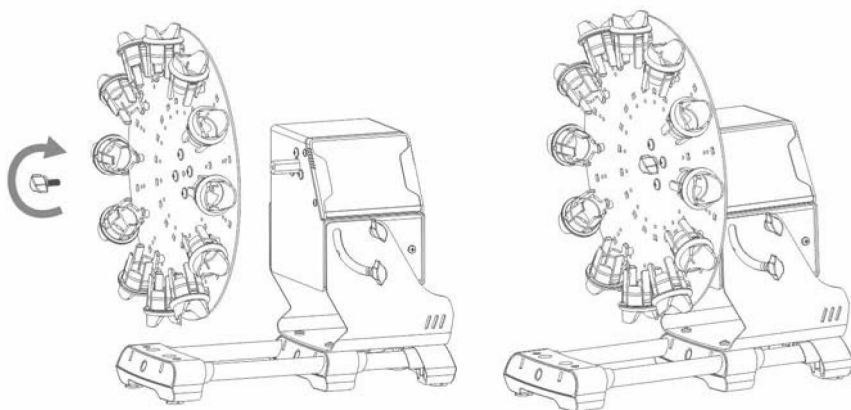

7. OPERATION

7.1 POWERING THE DEVICE ON

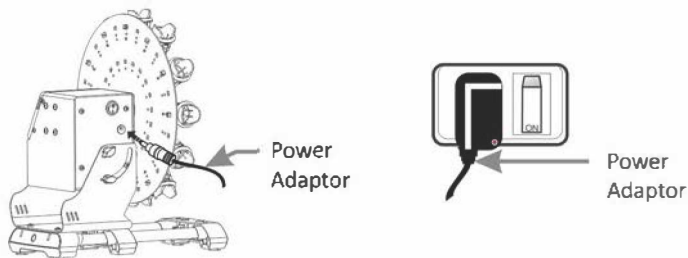

After connecting the power adaptor to back side of the device, switch the main power supply to “ON” & then switch the device on from the rear. Make sure that tubes are loaded properly before use.

7.2 SPEED SETTING

Press ‘Speed’ to select speed value and then press ‘Increment / Decrement ’ to set required speed. The speed for operation ranges from 10 RPM to 80 RPM with incremental/decremental steps of 1 RPM. Speed values are saved after blinking 5 times.

7.3 TIME SETTING

Press “Time” to select time value and use increment or decrement button to set run time. Run time for operation can be set between 1 minute to 99 minutes with an incremental/decremental step of 1 minute. It can also be set for continuous or infinite mode indicated by ‘ ∞ ’ in time display. The value will be saved after 5 blinks. The Countdown timer will get activated as soon as the operation starts. Time cannot be modified when the unit is in operation.

7.4 START / STOP OPERATION

Once the required speed and time are set, press “Start / Stop” to START operation. Speed gradually increases from lower RPM to set RPM and time takes effect as soon as the operation starts.

Press “Start / Stop” again to STOP the ongoing operation at any time. Speed gradually decreases from set RPM to zero (0) and stops in a few seconds.

NOTE: Speed and time cannot be changed/modified during operation.

7.5 DEFAULT PULSE MODE

Pulse mode is used for vigorous mixing of samples by rolling with a momentary clockwise and counter clockwise pause every 30 seconds. Default cycle time set for pulse mode is 30 seconds.

7. OPERATION

Set required speed and total run time before activating pulse mode to guide the device to start pulse mode operation for that particular speed and total run time. Once the speed and total run time are set, press “Pulse Button” to START pulse mode operation for that particular speed and total run time. In pulse mode, pulse LED will glow indicating pulse mode operation is activated.

Example: Speed set to 50 RPM and total run time set to 2 minutes. There will be rotating motion in clockwise direction for 30 seconds (cycle time). After completion of 30 seconds, disc plate will have a 2 cycles of momentary pause in clockwise and counter clockwise direction. Post these 2 cycles, disc plate will have a rotating motion for 30 seconds in counter clockwise direction. This entire process constitutes 1 Pulse cycle.

Press “Pulse” again to stop ongoing pulse mode operation. User can also Press “Start / Stop” to STOP ongoing pulse mode operation.

7.6 PROGRAM MODE

The program mode operation feature allows the user to save 9 programs which can have different speed and time parameters. Users can use any of these programmed parameters by simply turning on the program mode.

To turn the program mode on, hold down “Prog” until “Prog on” displays indicating program mode is activated.

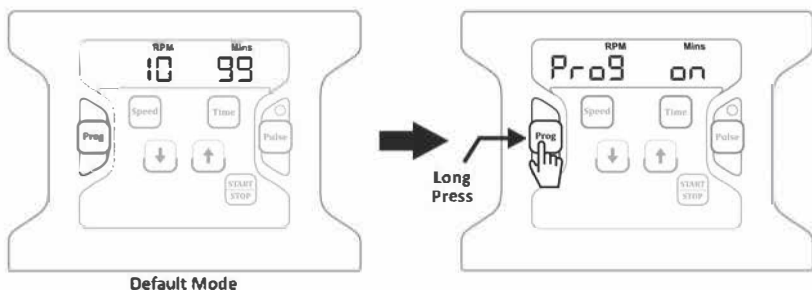

After a few seconds, the display will show “P1” and “speed & time value” alternatively. This shows that the current program is P1 with some RPM and time value.

7. OPERATION

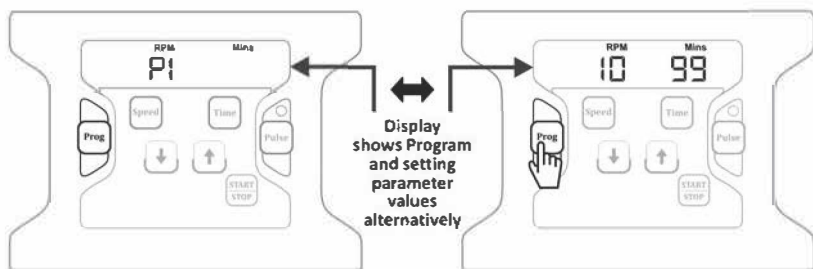

Press the “Program” button to select any program from “P1 to P9”. Programs can also be selected by pressing “increment or decrement” button. Once the desired program is selected, press the “speed button” to select and set speed value. Press “Time” to select and set time value.

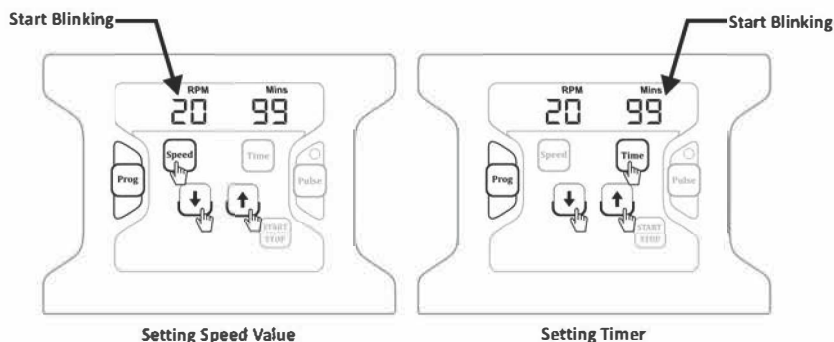
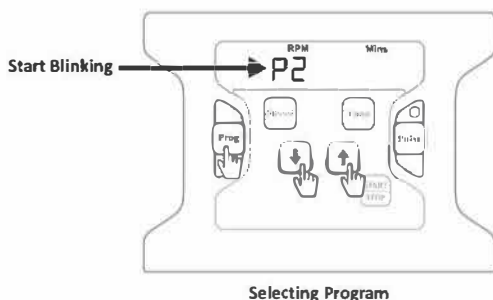

Speed and time value for that particular program is now saved. Press the “Start Button” to start the program mode operation. Once set RPM is reached, the program “Px” (with x = 1 to 9) and its “Speed” & “Time” value will display alternatively.

7. OPERATION

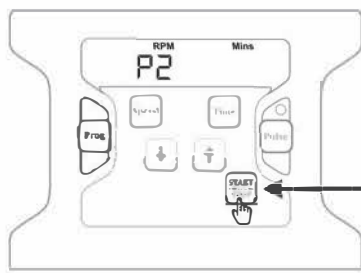

Press "START" button to start Program Mode Operation

To stop operation, press "Stop".

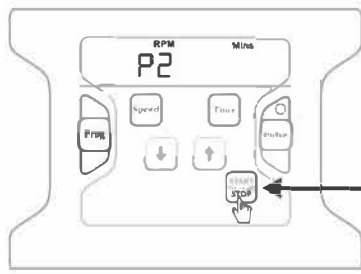

Press "STOP" button to stop Program Mode Operation

To leave Program mode, hold down the "Program" button again to turn OFF the Program mode. It will display "Prog off" indicating program mode is off.

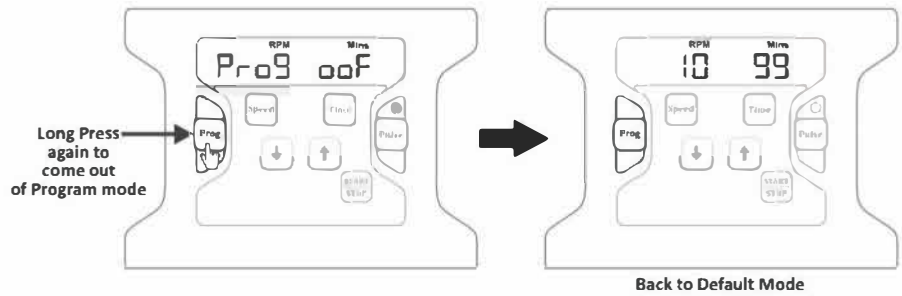

Long Press again to come out of Program mode

Back to Default Mode

NOTE: On every restart, the device automatically comes out of program mode. It shows the last run default speed and time value.

7. OPERATION

POWER MODE

The function of this particular feature is that in case of power failure, equipment saves the SPEED, TIME and other details as set by the user. When the power returns, equipment runs for the remaining time left with cycle time of +/- 5 mins. Equipment saves the run time every 5 minutes of operation.

To select this feature, long press "TIME" button. Unless and until this feature is not switched on, disc rotator will not resume its operation after power failure.

***Example:** User has set RPM of 45, time of 35 mins. After completion of 23 mins, there was power cut and operation comes to a stand still. Just before the power cut, remaining time seen on the display was 23 mins. When the power returns, the will assume its operation from 25 mins with the set RPM and other operational values.*

8. REMOVAL OF TUBES FROM DISC PLATE

In order to remove tubes from the disc plate, do not try to rotate the disc plate by bare hands. Procedure to remove the tubes attached at the bottom of the disc plate is mentioned below :

- 1) Single press PULSE button to rotate the disc plate so that the tubes at the bottom of the disc plate comes at the top.
- 2) Now pull out the tubes from the clamps of the disc plate one by one.
- 3) Similarly, follow the above process to remove the tubes in order to avoid damage to the disc plate & tubes.

9. MAINTENANCE & CLEANING



Warning: Ensure the unit is disconnected from the power supply before attempting maintenance or cleaning.

- Clean the unit by a soft damp cloth or mild non-corrosive (pH≤8) detergent and do not spray the unit.
- Wear clean when cleaning and be sure that the unit completely dry before operation.
- Cleaning is made easier if spillages are attended promptly.
- In any case, spillages of acids and alkali must be removed immediately as these chemicals can attack and damage the casework finish.
- Ensure that the appropriate safety precaution is observed.

10. WARRANTY STATEMENT

This product is warranted to be free from defects in material and workmanship for a period of two (2) years from the date of purchase. Your product will be duly repaired

10. WARRANTY STATEMENT

upon prompt notification in compliance with the following conditions :

This warranty is valid only if the product is used for its intended purpose and within the guidelines specified in this instruction manual. This warranty does not cover damage caused by accident, neglect, misuse, improper service, natural forces or other causes not arising from defects in original material or workmanship. This warranty does not cover any incidental or consequential damages, commercial loss or any other damages from the use of this product.

The warranty is invalidated by any non-factory modification, which will immediately terminate all liabilities on us for the products or damages caused by its use. The customer shall be responsible for the product or use of products as well as any supervision required for safety. If requested the products must be returned to the distributor in well packed and insured manner and all shipping charges must be paid.

NOTE: *Some states do not allow limitation on the length of implied warranties or the exclusion or limitation of incidental or consequential damages. This warranty gives you specific legal rights. This warranty is given expressly in lieu of all other warranties, expressed or implied.*

The purchaser agrees that there is no warranty of merchantability or of fitness for any intended purpose and there are no other remedies or warranties, implied, which extend beyond the description on the face of the agreement. This warranty is only applicable to the original purchaser.

Product received without proper authorization will not be processed for warranty or service. All items returned for service should be sent with postage prepaid in the original packaging or other suitable packaging, padded to avoid damage. We will not be responsible for damage incurred by improper packaging.

NOTE: *This warranty is valid only if the warranty is registered with the supplier within 30 days from the date of purchase.*

For you reference, make a note of serial number, date of purchase and supplier here.	
Serial No.:	Purchase Date:
Supplier:	

11. PRODUCT DISPOSAL

In case the product is to be disposed of, the relevant legal regulations are to be observed.

Information on the disposal of electrical and electronic devices in the European Community

11. PRODUCT DISPOSAL

The disposal of electrical devices is regulated within the European Community by national regulations based on EU Directive 2012/19/EU on waste electrical and electronic equipment (WEEE). According to these regulations, any devices supplied after 13.06.05 in the business to business sphere, to which this product is assigned, may no longer be disposed off in municipal or domestic waste. They are marked with the following symbol to indicate this.

As disposal regulations within the EU may vary from country to country, please contact your supplier if necessary.





Accumax Lab Devices Private Limited

Plot No. 15, 16 & 32 GIDC Electronic Park SEZ, Sector 26, Gandhinagar, Gujarat, India - 382026.

Website: www.neuation.com