



User Manual

Veterinary Monitor

Model: iM 12&iM 15

About the User Manual

This user manual is only used for the operation on this series of equipments. The company will not take any responsibility for consequences caused by misuse of the manual.

This user manual contains proprietary information whose copyright is protected and reserved. Without license from the company, any photocopying, replication or translation of the manual is prohibited.

For technical development and updating of the present product, the company reserves the rights to amend and alter the contents of the manual. If the alternation does not involve the safety of the product having been sold, the customer will not be informed individually.

For reasons of technical updating and customers' special requirements, if the product performance is unaffected, some assembled units may not be in accordance with the standard configurations indicated in the manual.

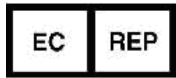

Shanghai International Holding Corp. GmbH (Europe)
Eiffestraße 80
20537 Hamburg
GERMANY



Shenzhen Biocare Bio-Medical Equipment Co., Ltd.
#16-1, Jinhui Road, Jinsha Community, Kengzi Sub-District, Pingshan New
District, 518122 Shenzhen, PEOPLE'S REPUBLIC OF CHINA
Tel: 86-755-33005899 Fax: 86-755-27960643
Website: <http://www.biocare.com.cn>

Content

Preface	1
Customer Required Reading	3
Chapter 1 Operation Safety Information	5
1.1 Safety Information	5
1.2 Influence On the Environment and Energy Sources	7
1.3 Safety Classification.....	7
1.4 Safety Requirements	7
1.5 Device Identifications	9
Chapter 2 Overview.....	11
2.1 Brief Introduction.....	11
2.1.1 Applicability	11
2.1.2 Contraindications.....	11
2.2 Configuration Composition.....	11
2.3 Main Unit	12
2.3.1 Front View.....	12
2.3.2 Side View	15
2.3.3 Back View	17
2.4 Modules.....	17
2.5 Screen Display	18
2.5.1 Main Interface.....	18
2.5.2 Interface Explanation.....	18
2.6 Shortcut Key	22
Chapter 3 Basic Operation	23
3.1 Installation.....	23
3.1.1 Unpacking and Checking.....	23
3.1.2 Environmental Requirements	23
3.1.3 Normal Operation Conditions.....	23
3.2 Operation Preparation	24
3.2.1 A.C. Power Supply Connection.....	24
3.2.2 Turn On	24
3.2.3 Sensor Connection.....	25
3.2.4 Recorder Checking	25
3.3 Monitoring	25
3.4 Turn Off	25
3.5 Input Board	26
3.6 Touch Screen (Optional).....	26
3.7 Interface Setup	26
3.8 Main Menu.....	28
3.9 General Setup.....	28
3.9.1 Monitor Definition.....	28
3.9.2 Screen Type Setup.....	28
3.9.3 Screen Brightness and Panel Backlight Adjustment.....	28

3.9.4 Time and Date Setup	28
3.9.5 Audio Setup	29
3.9.6 Help Menu	29
3.10 Configuration Management	29
3.10.1 Recent Configuration Self-recovery	29
3.10.2 Turning-on Default Configuration Setup.....	29
3.10.3 User Configuration Storage	30
3.10.4 User Configuration Deletion.....	30
3.10.5 Default Configuration Manual Restore.....	31
Chapter 4 Animal Management	33
4.1 Admit Animal	33
4.2 Quick Admit.....	33
4.3 Edit Animal Demographics.....	33
4.4 Discharge Animal.....	33
4.5 Data Management	34
4.6 Central Monitoring System	34
Chapter 5 User Interface.....	35
5.1 Interface Style Setup	35
5.2 Standard Interface	35
5.3 Minitrends Interface	36
5.4 BigNumerics Interface	37
5.5 OxyCRG Interface	37
5.6 View Other Bed Interface	38
5.7 C.O. Measure Screen (Optional)	40
5.8 7 Lead Half Screen.....	41
5.9 7 Lead Full Screen	41
Chapter 6 Parameter Monitoring	43
6.1 ECG.....	43
6.1.1 ECG Measuring Principle.....	43
6.1.2 Definition of ECG Monitoring	44
6.1.3 ECG Intended Use.....	44
6.1.4 Safety Information	44
6.1.5 Monitoring Procedures	45
6.1.6 ECG Display.....	47
6.1.7 ECG Setup.....	47
6.1.8 ST Analysis	49
6.1.9 Arrhythmia Monitoring	50
6.1.10 Arrhythmia Alarm	51
6.1.11 ECG Relearn.....	55
6.2 Resp.....	56
6.2.1 Resp General Description	56
6.2.2 Resp Display.....	56
6.2.3 Placing Respiration Electrodes	57
6.2.4 Resp Setup.....	57

6.3 PR.....	58
6.3.1 PR General Description	58
6.3.2 PR Source	59
6.3.3 Alarm Source Setup.....	59
6.3.4 Pulse Volume Setup.....	59
6.4 SpO ₂	59
6.4.1 SpO ₂ General Description	59
6.4.2 Safety Information.....	61
6.4.3 SpO ₂ Module	62
6.4.4 Monitoring Steps	62
6.4.5 SpO ₂ Setup.....	63
6.4.6 Influencing Factors of Measure	65
6.4.7 Masimo Information	65
6.4.8 Nellcor Information	65
6.5 NIBP	66
6.5.1 NIBP General Description.....	66
6.5.2 Safety Information.....	67
6.5.3 Measure Restriction.....	69
6.5.4 Measure Mode	69
6.5.5 Measure Procedure	69
6.5.6 NIBP Display.....	70
6.5.7 NIBP Setup.....	71
6.5.8 NIBP Leakage Test.....	72
6.5.9 NIBP Accuracy Test.....	73
6.6 Temp	74
6.6.1 General Description.....	74
6.6.2 Safety Information.....	75
6.6.3 Measure Procedure	75
6.6.4 Measure Display	76
6.6.5 Temp Unit Setup.....	76
6.6.6 Alarm Setup.....	76
6.7 IBP (Optional).....	76
6.7.1 General Description.....	76
6.7.2 Safety Information.....	77
6.7.3 Monitoring Steps	77
6.7.4 IBP Display	78
6.7.5 IBP Setup.....	78
6.7.6 Sensor Zero-Calibration	79
6.8 CO ₂ (Optional)	79
6.8.1 General Description.....	79
6.8.2 Side-stream CO ₂ Module.....	81
6.8.3 Main-stream CO ₂ Module	83
6.8.4 CO ₂ Setup	85
6.8.5 Zero.....	86
6.8.6 Calibrate	87
6.8.7 Influencing Factors of Measure	88
6.8.8 Faulty Handling	88

6.8.9 Emissions.....	88
6.9 C.O. (Optional)	89
6.9.1 General Description.....	89
6.9.2 Influencing Factors of Measurement.....	89
6.9.3 Setting Up the C.O. Measurement.....	90
6.9.4 Understanding the C.O. Display.....	92
6.9.5 Changing C.O. Settings.....	92
6.9.6 Measuring the Blood Temperature.....	93
6.10 AG anesthetic gas (optional).....	93
6.10.1 Overview.....	93
6.10.2 AG Display.....	93
6.10.3 MAC Value.....	94
6.10.4 Mainstream AG module.....	94
6.10.5 Sidestream AG module.....	99
6.10.6 AG Setup.....	105
6.10.7 Replacing Anesthetic.....	105
6.10.8 Measurement Influencing Factors.....	106
6.10.9 Emissions.....	106
Chapter 7 Alarm.....	107
7.1 General Description.....	107
7.2 Alarm Type.....	107
7.3 Alarm Level.....	107
7.4 Alarm Mode.....	107
7.5 Alarm Setup.....	108
7.5.1 Global Alarm Interface.....	109
7.5.2 Parameter Alarm Setup.....	109
7.6 Alarm Configuration.....	110
7.7 Alarm Setup.....	111
7.7.1 Alarm Setup Interface.....	111
7.7.2 Parameter Alarm Setup.....	112
7.8 Alarm Pause.....	113
7.9 Alarm Silence.....	113
7.10 Alarm Detection and Counter Measures.....	114
7.11 Other Bed Alarm.....	114
7.11.1 Other Bed Alarm Auto Prompting.....	114
7.11.2 Other Bed Alarm Silence.....	114
Chapter 8 Freeze and Review.....	115
8.1 Enter Freeze.....	115
8.2 Remove Freeze.....	115
8.3 Record Frozen Waveforms.....	115
8.4 Review.....	115
8.4.1 Review Window.....	115
8.4.2 Graphic Trends.....	116
8.4.3 Tabular Trends.....	117
8.4.4 Events.....	118

8.4.5 NIBP List.....	119
8.4.6 Long ECG.....	120
Chapter 9 Calculations.....	123
9.1 General Description	123
9.2 Medication Calculation	123
9.3 Hemodynamic Calculation.....	125
9.3.1 Review.....	125
9.3.2 Output.....	126
9.4 Renal Function Calculation, Oxygenation Calculation, Ventilation Calculation.....	126
Chapter 10 Recording	127
10.1 Recorder.....	127
10.2 Record Setup.....	127
10.3 Start and Stop Recording	128
10.4 Install Recording Paper.....	128
10.5 Cleaning of the Thermal Print Head	129
Chapter 11 Other Functions.....	131
11.1 Power-On	131
11.2 Colors of the Measured Physiological Parameters.....	131
11.3 Analog Output Setup.....	131
11.4 Nurse Call System.....	131
11.5 Defibrillation synchronization.....	132
11.5 Manual Event	133
11.6 Defaults	133
11.7 System State Indicator.....	133
11.8 Standby Mode	134
Chapter 12 Battery	135
12.1 General Description	135
12.2 Battery Installation	136
12.3 Battery Recycling.....	136
Chapter 13 Cleaning and Maintenance	137
13.1 Cleaning of Monitor.....	137
13.2 Disinfecting of Monitor.....	137
13.3 Fan Cleaning	137
13.4 Storage of Monitor	138
13.5 Transport.....	138
13.6 Inspection of Monitor.....	138
Chapter 14 Maintenance.....	139
14.1 Safety Information	139
14.2 NIBP Accuracy Test	139
14.3 NIBP Overpressure Test	139
14.4 NIBP Leakage Test	139
14.5 User Maintain.....	139

14.6 Demo Model	141
14.7 Monitor System Information.....	141
Chapter 15 Troubleshooting and Solutions.....	143
15.1 Check before Use	143
15.2 The Monitor cannot be Turned On.....	143
15.3 The Monitor cannot be Shut Down Normally with ON/OFF Switch.....	143
15.4 No Display on Screen.....	143
15.5 Interference to ECG Signal Too High or Baseline Too Coarse	143
15.6 No Measured Result of NIBP.....	144
15.7 No Measured Result of SpO ₂	144
15.8 Measure Result of EtCO ₂ is Low (Optional).....	144
15.9 The Sound of Sidestream CO ₂ Pump Becomes High (Optional).....	144
15.10 Body Temperature without Numerical Value or Inaccurate Readings.....	144
Appendix A Packaging and Accessories	145
A.1 Packaging	145
A.2 Accessories.....	145
Appendix B Product Specifications.....	147
B.1 Safety Specifications	147
B.1.1 Product Classification	147
B.1.2 Environment Specifications	148
B.1.3 Power Specifications.....	148
B.2 Physical Specifications.....	148
B.3 Hardware Specifications.....	148
B.4 Data Storage	150
B.5 Wireless Network	150
B.6 Measuring Specifications	150
B.6.1 ECG Monitoring	150
B.6.2 Respiration (Resp) Monitoring	152
B.6.3 SpO ₂ Monitoring	153
B.6.4 PR Specifications.....	154
B.6.5 NIBP Monitoring	155
B.6.6 Temperature (Temp) Monitoring	156
B.6.7 IBP Monitoring	156
B.6.8 CO ₂ Monitoring (Optional).....	157
B.6.9 C.O. Specifications(Optional).....	160
B.6.10 AG Specifications (Optional).....	161
B.6.11 Recorder Specifications	162
Appendix C Alarm Information.....	163
Appendix D Factory Default Setup	169
D.1 Animal Demographics.....	169
D.2 Alarm.....	169
D.3 Alarm Limit.....	170
D.3.1 >20kg	170

D.3.2 10~20kg	171
D.3.3 <10 kg	172
D.4 Screen Setup	173
D.5 User Maintain	173
D.6 ECG	173
D.7 NIBP	175
D.8 SpO ₂	175
D.9 Resp	176
D.10 IBP	176
D.11 CO ₂	176
D.12 C.O.	177
D.13 AG	177
D.14 PR	177
D.15 Other Setup	178
Appendix E EMC- Guidance and Manufacture' s Declaration	179
E.1 Guidance and manufacture' s declaration-electromagnetic emissions for all EQUIPMENT and SYSTEMS	179
E.2 Guidance and manufacture' s declaration-electromagnetic immunity for all EQUIPMENT and SYSTEMS	179
E.3 Guidance and manufacture' s declaration-electromagnetic immunity for EQUIPMENT and SYSTEMS those are not LIFE-SUPPORTING	180
E.4 Recommended separation distance between portable and mobile RF communications equipment and the EQUIPMENT or SYSTEM for EQUIPMENT or SYSTEM that are not LIFE-SUPPORTING	181

-- The Blank Page --

Preface

Thank you for using the monitor produced by our company.

In order to help you master the operation on this series of monitors as soon as possible, a user manual (the current manual) has been attached to this series of products. It is strongly recommended you read it before you install and use the product for the first time.

For performance and reliability improvements, some alternations will be made to the equipment (including the hardware and software) by the manufacturer at times. On that occasion, although some information will be altered or added, there is still a possibility of mismatch between the description in the manual and the product. Thank you for understanding. For any error and omission in the manual, your notification is welcomed.

This series of monitors contain iM 12 (Named as 12 inches monitor in the following) and iM 15 (Named as 15 inches monitor in the following).

Manual Abstract

[Main composition and performance]

This series of monitors are mainly composed of a host processor and other corresponding functional accessories (including electrocardiograph (ECG) lead cables, blood pressure cuffs and catheters, invasive pressure monitoring sensors (optional modules), blood oxygen probes, body temperature probes, EtCO₂ measurement components (optional modules), and anesthesia gas measurement components (optional modules).)

[Scope of application]

This series of monitors application is for monitoring animals' electrocardiogram, respiration, pulse rate, heart rate, pulse oxygen saturation, body temperature, non-invasive blood pressure, invasive blood pressure (optional), EtCO₂ (optional), and Anesthetic gas (optional) in a medical therapy unit.

[Cautions, warnings and suggestion]

- 1) This series of monitors do not have components for the customer's self-maintenance. When something is out of order, please don't disassemble on your own.
- 2) This series of monitors do not belong to treatment facilities, and cannot be applied for household use.
- 3) The optional modules involved can be equipped according to the customers' need. The required equipment has been preset by the manufacturer before this series of monitors come from the factory.
- 4) Don't allow contact to the animal, hospital bed or monitor during defibrillation.
- 5) Please turn off the power before cleaning this series of monitors.
- 6) Don't use this series of monitors under the condition of a high temperature, high humidity, high flammability, high dust, or electromagnetic radiation.
- 7) Please keep the mains power source and grounding situations safe and stable.
- 8) (For other information, please refer to the manual.)

-- The Blank Page --

Customer Required Reading

This section will tell you what operative procedures should be paid close attention to, how to avoid abnormal operation, and what possible detrimental risks might occur to this series of monitors or animal when you use this series of monitors.

The company's Imperatives: please read the manual thoroughly before using this series of monitors, and perform the operative procedures according to the instructions described in it; The company won't take any safe, reliable or performance guarantee responsibility for abnormal monitor phenomena or animal body injures caused by violation of the requirements concerning monitor application or maintenance indicated in this section and the user manual, nor offer free maintenance for such breakdowns. Once again, the company reminds you to read the contents of the current section and the manual before use.



- ☛ For < 10 kg animals and > 20 kg animals model is prohibited for blood pressure measurement. Or, the pressure may cause limb injuries, or even limb necrosis.
- ☛ This series of monitors can only be used for one animal at a time.
- ☛ Customer required reading blood pressure monitoring is prohibited for animals with a serious hemorrhage tendency or sickle cells. Or, local hemorrhage may occur.
- ☛ A cuff is prohibited for an infused or intubated limb or an area with local skin injuries. Or, it may lead to limb injuries.
- ☛ Continuous use of the ear-clamping or tongue-clamping pulse oxygen sensor may cause discomfort or a pressure pain, especially for animals with microcirculation disturbance. No more than two-hour clamping for the same finger is recommended.
- ☛ More careful inspection of the pulse oxygen sensor measurement site should be done for animals with special needs. The sensor cannot be placed on edematous or fragile tissues.
- ☛ This series of monitors must be well grounded in order to prevent possible electrical danger as well as to secure a good ECG signal quality.
- ☛ Although all animal contact parts of this series of monitors have been approved by bio-compatibility tests, some individuals may still have allergies to monitors parts. The application of this series of monitors must be stopped for animals that have allergies to monitors.
- ☛ All measurement cords and plastic tubes should be kept away from the animal's neck in order to avoid asphyxia caused by neck winding.
- ☛ Accessories cannot be replaced indiscriminately. When accessory replacement is necessary, an accessory of the same type provided by the manufacturer or approved for this series of monitors should be used. Only the accessories from the same manufacturer and of the same type can be used for accessory replacement. Or, adverse consequences of safety and bio-compatibility may occur.
- ☛ Do not open the pulse oxygen sensor and look directly at the light device (as the infrared light can't be detected by eyes). The warning also applies to maintenance persons. The light may harm to your eyes.
- ☛ If this series of monitors falls accidentally, its use must be stopped. Only after safety and technical index tests prove this series of monitors is still operational, it can go on to being used.
- ☛ When blood pressure is measured, the manual mode is recommended by the manufacturer. If the automated or continuous model is selected, a qualified observer should be present.
- ☛ For animals with pacemakers, heart rate meter may be in asystole or arrhythmia the pacemaker

pulse count. Do not rely solely on heart rate alarm. Should be closely monitoring animals with pacemaker.

- * Do not modify this series of equipments without authorization of the manufacturer. If this series of equipments are modified, appropriate inspection and testing must be conducted to ensure continued safe use of the equipment.
- * Please read clinical limitations and contraindication information carefully.

Chapter 1 Operation Safety Information

1.1 Safety Information

-  Warning: emergencies may be caused which may lead to death, severe bodily injuries or property loss if you do not follow this advice.
-  Explanation: instructions or explanations are provided for better use of this series of product.
-  Attention: important information and prompts are included, which may lead to slight bodily injuries or breakdowns of the product if you do not follow them.



Attention

- For the sake of safety as well as more effective use of this series of monitors, please read the user manual carefully to thoroughly know the correct operative method.

Warning

- This series of monitors must be placed on a smooth and flat worktable. Strong vibration or impact should be avoided when being moved. Please check the device, connection wires and accessories before use to be sure that they work normally and safely.
- Make sure that the frequency and voltage of the A.C. power source satisfies the requirements, and has enough capacity. This series of monitors can only be connected to an outlet with a grounding wire. If the outlet is not connected to a grounding wire, please use the battery for power supply instead of the outlet.
- Make sure that the room has a good power supply system and a good ground circuit, or, injuries may occur to the animal.
- The electrodes and their connectors as well as the accessories should not have contact with other conducting wires including the ground.
- Do not open the outer shell of the device, or, electric shock may occur. The maintenance and upgrading of this series of monitors can only be performed by the maintenance persons trained or authorized by the company.
- When there is a doubt about the integrity of the grounding wire, the battery (DC power) in the machine should be used.
- Do not touch the animal or the hospital bed when this series of monitors and a cardiac defibrillator are being used. All electrodes connected and unconnected to the animal, as well as the animal himself, need not be grounded. For the protection from the defibrillator discharge procedure, please use the cable provided by the company. This series of monitors are not recommended to be concurrently used with other electrical stimulators. If this is necessary, it should be done under direct guidance of specialized technicians.
- Be cautious when the animal is connected with more than one instrument, because the total leak current may be harmful to the animal. Devices in compliance with the standard of IEC60601-1 are allowed to be connected to this instrument, and the total leak current should be measured by the users to determine that if it meets the requirement and can be used after connection.
- The signal input/output ports (when needed to use) are only permitted to be connected with devices which compliance with the standard of IEC 60601-1 when used within the animal environment, and compliance with the standard of other IEC or ISO standard when used outside the animal environment, the composition of the system should comply with the requirements of IEC 60601-1-1.

- In order to prevent burns, a high frequency electrosurgical should be kept far away from the electrodes. The electrical resistance between the electrosurgical and the animal's body should be as small as possible and great caution should be used.
- The alarm sound volume and limits should be set up according to the animal's actual status. Veterinary Monitoring cannot only depend on the sound alarm system. When the sound volume is tuned down to the minimum, it may place the animal in danger. Therefore, close attention should be paid to the animal's actual clinical status.
- The physiological waveform, physiological parameters and alarm information displayed by this series of monitors can only be used as reference by the physician. They cannot be directly used as the basis for clinical treatment.
- If there are any anomalies during use, please turn off this series of monitors immediately for examination.
- Please place the power source and all types of accessory electric cables carefully, in case of they entangle the animal; the winding may even cause the animal's asphyxia, and electrical disturbance between them.
- Handling of the packing materials should follow the associated local regulations, or the hospital waste treatment rules. The packing materials should be placed out of reach of children.

	Do not use where anesthetic gases, oxygen, hydrogen and other combustible gases or chemical are used, or there will be danger of explosion or fire.
	Do not use in hyperbaric oxygen chamber, or there will be danger of explosion or fire.

Explanation

- For the sake of the animal's safety, please use the accessories specified in the user manual.
- When the device and its accessories are nearing the expiration date for use, they should be disposed of according to associated local regulations or hospital rules.
- Electromagnetic fields can influence the performance of this series of monitors. Therefore, any device used nearby should meet the corresponding EMC requirement. A mobile telephone, X rays and MRI equipment are all likely to be an interference source as they can emit high-intensity electromagnetic radiation.
- Before the power source is switched on, please be sure that the voltage and frequency satisfy the requirements indicated on the label attached to the device or in the user manual.
- Please install or carry the device appropriately to avoid device damage caused by falls, collision, strong vibration and other external mechanical forces.
- The device and its accessories should be checked and calibrated regularly, or, the technical specifications in the user manual may not be obtained.

Attention

- Please install the device at a place where the observation, manipulation and maintenance of the device is convenient.
- Please put the user manual near the device for convenient and quick reference when necessary.
- It should not to position the equipment so that it is difficult to operate the disconnection device from the supply mains.
- The software of this device is developed according to the IEC60601-1-4 standards, which has

minimized the possibility of the risks caused by programming errors.

- The user manual introduces the product according to its most complete configurations. Therefore, your purchased product may lack some configurations or corresponding functions.

1.2 Influence On the Environment and Energy Sources

Handling of the packing materials, exhausted battery and scrap materials should be carried out according to local regulations. The user should carry out reasonable handling for the scrap product and materials according to the local laws and regulations, and offer possible help for waste classification and recycling.

1.3 Safety Classification

This series of monitors belong to the following types:

- 1) Based on shockproof types:
Class I, internal power supply.
- 2) Based on shockproof levels:
Type BF (*) applied parts: EtCO₂ measurement module (optional), and anesthetic gas module (optional).
Type CF (*) applied parts: ECG (Respiration) measurement, IBP measurement module (optional), the NIBP measurement module, Temp measurement module, SpO₂ measurement module and C.O. measurement module.
(Attention: * represents an anti-defibrillation function.)
- 3) Based on the levels of protection from noxious liquid infiltration:
A common closed device which cannot prevent noxious liquid infiltration.
- 4) Based on safety levels in an atmosphere of easily flammable anesthetic gas mixed with air or with oxygen or nitrous oxide:
This series of monitors cannot be used in an atmosphere of easily flammable anesthetic gas mixed with air or with oxygen or nitrous oxide.
- 5) Based on duty:
A continuously-running equipment.

1.4 Safety Requirements

◆ Animal Number

This series of monitors can only monitor one animal at a time.

◆ Interference

Do not use a mobile telephone near this series of monitors as the high-intensity electromagnetic interference emitted from it may strongly influence the normal operation of this series of monitors.

◆ Water Exposure Prevention

This series of monitors must be protected from water exposure in order to prevent electrical shock and to reduce equipment breakdown. If water enters accidentally, the use of this series of monitors should be stopped immediately. It can only be used again after maintenance by specialized technicians.

◆ Accuracy

When there is a doubt about any parameter displayed or printed, please adopt another method to determine the animal's physiological parameter. Insure that your monitor works accurately.

◆ Alarm

The monitoring process cannot only depend upon the sound alarm. Tuning-down or turning-off of the alarm sound volume may place the animal in danger. Caution: the most reliable monitoring can only be done with close monitoring of the animal combined with correct use of the monitoring device.

Attention: the alarm function of monitoring devices should be checked regularly.

◆ **Before Use**

All connection cables should be carefully checked before use. Any damaged cable or connector should be replaced immediately.

◆ **Cable**

The cables should be kept away from the animal's neck in case of entanglement.

◆ **Data Clearing**

When this series of monitors are used for another animal, the preceding animal's data should be cleared. You can clear the data by selecting [Main Menu], [Animal Management] and [Data Clearing], sequentially, and then pressing Confirmation.

◆ **Packing Materials Handling**

Packing materials handling should observe local rules on waste management. They should be kept out of reach of children.

◆ **Explosion Hazard**

Do not use this series of monitors under the condition of flammable gas, vapor or liquid.

◆ **Leakage Current Test**

When this series of monitors monitor are concurrently used with other devices, the leakage current should be tested by specialized technicians. Only after safety is secured, can it be used for the animal.

◆ **Battery**

This series of monitors have been equipped with batteries, which lose electricity even after the monitor has been turned off. Therefore, the battery should be fully charged and then taken out before the monitor is stored so that the service life of the battery is not shortened.

◆ **Accessory and Equipment Handling**

Disposable accessories can only be used once. Repeated use can lead to performance reduction and cross-contamination.

◆ **Service Life**

The service life for this series of monitors is five years. After the service life, this series of monitors and its accessories should be disposed of according to the associated laws and regulations. If you have any question about their handling, please contact the manufacturer or the agency.

◆ **Operation Instructions**

For the sake of continuously safe use of this series of monitors, please operate this series of monitors according to the instructions. However, these operation instructions can by no means substitute for the accepted medical practical experience in animal nursing.

◆ **Data Loss**

This series of monitors have the possibility of data loss at any time. Before this series of monitors return to normal, please monitor the animal closely, or use other equipment. If the monitor cannot return to normal within 60 seconds, please turn off the power and restart the monitor. After the monitor returns to normal, please check its monitoring status and alarm functions.

1.5 Device Identifications

◆ Safety Associated Identification



Type CF applied part, defibrillation-proof protection against electric shock, represents that type CF applied parts have a higher protection against electric shock (especially on permissive leakage current) compared to type BF applied parts.



Type BF applied part, defibrillation-proof protection against electric shock, represents that type BF applied parts have a higher protection against electric shock (especially on permissive leakage current) compared to type B applied parts.

◆ Other Identifications

Table 1.1 Identification Explanations

	Attention: please refer to the attached device files.		Turn on/Shut down
	AC POWER		Battery In Use
	Battery Charging		Waveform Freezing
	Screen Switching		Recording
	NIBP		Main Menu
	Alarm Silencing		Alarm Pausing
	Alarm Sound Off		Some Parameters Alarm Off
	USB Interface		Add-in Display Interface
	Isoelectric Terminal		Non-ionizing Radiation
	Network Interface		Dangerous Voltage
	Nurse call system interface and defibrillation synchronization interface		Analog Output Interface
	Separate handling markers for un used electrical and electronic devices (Please observe the local associated laws and regulations)		

-- The Blank Page --

Chapter 2 Overview

2.1 Brief Introduction

2.1.1 Applicability

This series of monitors can be used in monitoring or measuring the electrocardiogram (ECG), non-invasive blood pressure (NIBP), body temperature (Temp), respiration (Resp), EtCO₂ (optional), invasive blood pressure (IBP) (optional), cardiac output (C.O.)(optional) and Anesthetic gas module (AG) (optional) for a single vet. The monitoring data can be displayed, reviewed, stored and sent to another device.

This series of monitors are expected to be used in a highly-efficient sensitive nursing environment, including (but not restricted to) operating room monitoring, post- recovery, critical care, operative intensive care, respiratory intensive care, cardiac care, pharmacodynamic intensive care, etc.



Warning

- This series of monitors require use by specialized clinicians or under their guidance. The monitor user must have received sufficient associated training. Any unauthorized or untrained person is prohibited from operating the monitor.
- C.O. monitoring is restricted to animals > 20 kg only.

This series of monitors have the following monitoring functions:

- ◇ ECG: the heart rate, three- and seven-channel ECG waveforms, ST segment analysis, and arrhythmia analysis.
- ◇ Resp: respiratory rate and wave.
- ◇ Temp: dual-channel Temp data.
- ◇ SpO₂: oxygen saturation, pulse rate and pulse wave.
- ◇ Pulse rate (PR): pulse rate in one minute.
- ◇ NIBP: contractive pressure, diastolic pressure and mean blood pressure.
- ◇ IBP (optional): contractive pressure, diastolic pressure and mean blood pressure.
- ◇ C.O. (optional): the cardiac output and blood temperature.
- ◇ CO₂ (optional): the CO₂ concentration in the respiratory paths and airway respiratory rate.
- ◇ Anesthetic gas (AG) (optional): CO₂[AG], N₂O, AA, O₂;
- ◇ A central monitoring network system can be constructed as needed.

2.1.2 Contraindications

None

2.2 Configuration Composition

1. This series of monitors are composed of a mainframe and corresponding functional accessories (including ECG lead cables, blood pressure cuffs, IBP monitoring sensors (optional), blood oxygen probes, body temperature probes (optional), C.O. cables(optional), CO₂ measurement assemblies (optional), and Anesthetic gas measurement assemblies (optional) etc).

- 2. This series of monitors have four output channels for network communication, nurse call, defibrillation synchronization, VGA interface.
- 3. Basic Parameters
Heart rate, body temperature, pulse oxygen saturation, non-invasive blood pressure (contractive, diastolic and mean blood pressures), invasive blood pressure (Art, PA, LAP, RAP, ICP, CVP and P1/P2, optional), end expiration CO₂ (EtCO₂)/airway respiratory rate (awRR) (optional) and Anesthetic gas (CO₂[AG], N₂O, AA, O₂) (optional).

2.3 Main Unit

2.3.1 Front View

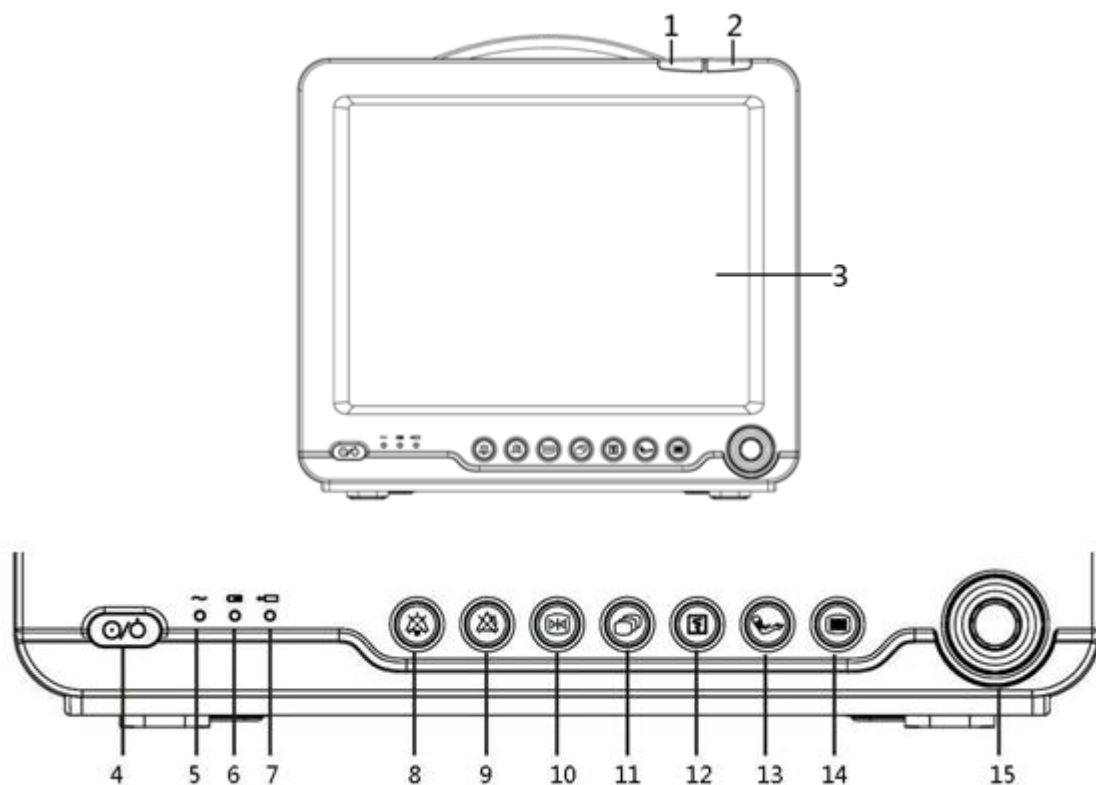

Figure 2.1 Front View of iM 12

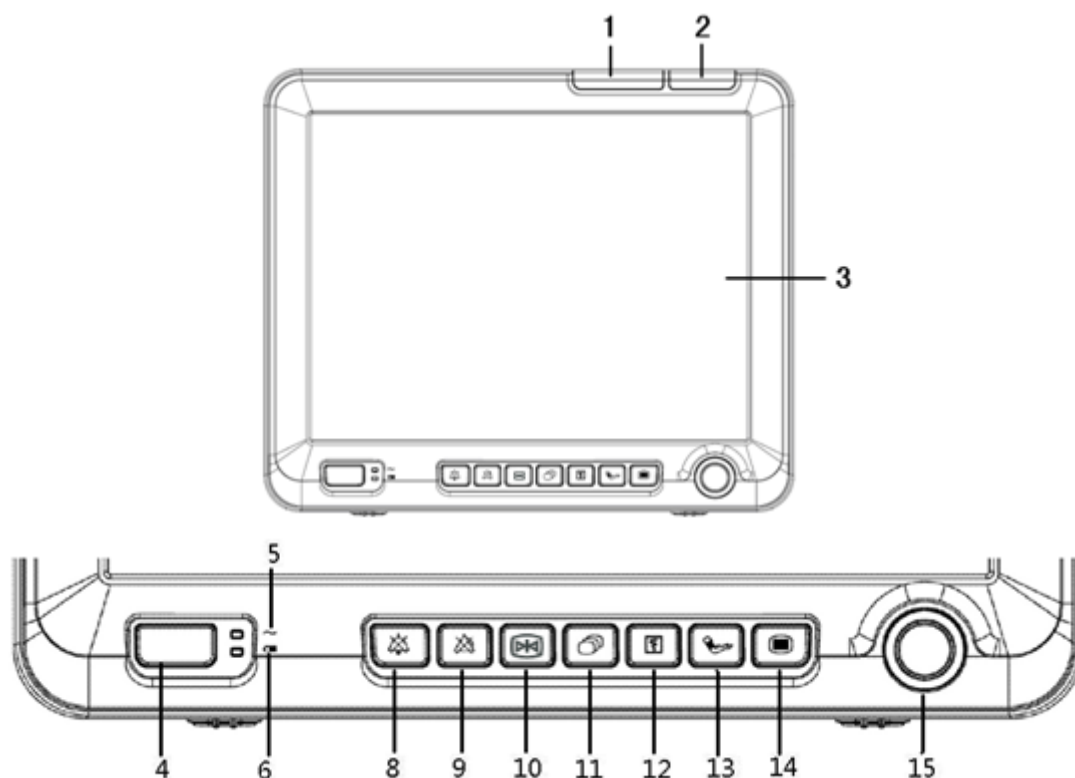

Figure 2.2 Front View of iM 15

1. Physiological Alarm Indicator Lamp

- Red with a high flicker frequency: a high-level alarm.
- Yellow with a low flicker frequency: a middle-level alarm.
- Constantly yellow without flicker: a low-level alarm.
- Blind: no physiological alarm.

2. Technical Alarm Indicator Lamp

This lamp lights blue, and it indicates two possibilities:

- Constantly: a technical alarm.
- Blind: no technical alarm.

3. Display Screen (12.1 inches or 15 inches)

4. Power Switch

- Turn on: press this button to start the monitor after A.C. power connection.
- Shut down: press this button to shut down the working monitor (the shut-down time lag depends upon the manufacturer's preset).

An indicator light has been mounted inside the switch. It turns on when the monitor is on, and turns off when the monitor is off.

5. A.C. Power Indicator Lamp

- On: power has been connected to the monitor.
- Off: power has been discontinued.

6. Battery Power Indicator Lamp (Only for 12 inches monitor)

- On: power is supplied by the battery.
- Off: battery is not in use.

Battery or Battery Charging Indicator Lamp (Only for 15 inches monitor)

- Battery is charged: Lights flickers;
- The charge is finished: Lights steadily;
- Power is supplied by the battery: Light is on (The monitor is on).
- Battery is absent: Light is off (The monitor is on).

7. Battery Charging Indicator Lamp (Only for 12 inches monitor)

- Battery is charged: Lights flickers;
- The charge is finished: Lights steadily;
- Power is supplied by the battery: Light is off.
- Battery is absent: Light is off.

8.  Alarm Silencing Button

Press this button to silence an alarm.  will be displayed in the information region. Other sounds (such as button pressing and ORS tones) will not be affected.

9.  Alarm Pausing Button

Press this button to pause an alarm.  will be displayed in the information region. Press it again to restore the alarm.

10.  Freezing Button

Press this button to freeze the waveform on the screen under a failure-free operation mode. Press it again to release the frozen waveform.

11.  Screen Switching Button

Press this button to switch the screen interface layout.

12.  Recording Button

If the monitor is equipped with a recorder, press this button to record the real-time waveforms. Press it again to stop the recording.

13.  NIBP Button

Press this button to start or stop NIBP measurement.

14.  Main Menu Button

If the main menu has not been displayed on the screen, press this button to show the main menu; if the main menu has already been displayed on the screen, you can return to the home screen by pressing this button.

15. Shuttle

- Rotating: the cursor can be moved by rotating the shuttle clockwise or counter-clockwise.
- Pressing: some menus can be entered or some functions can be chosen by pressing the pushbutton.

2.3.2 Side View

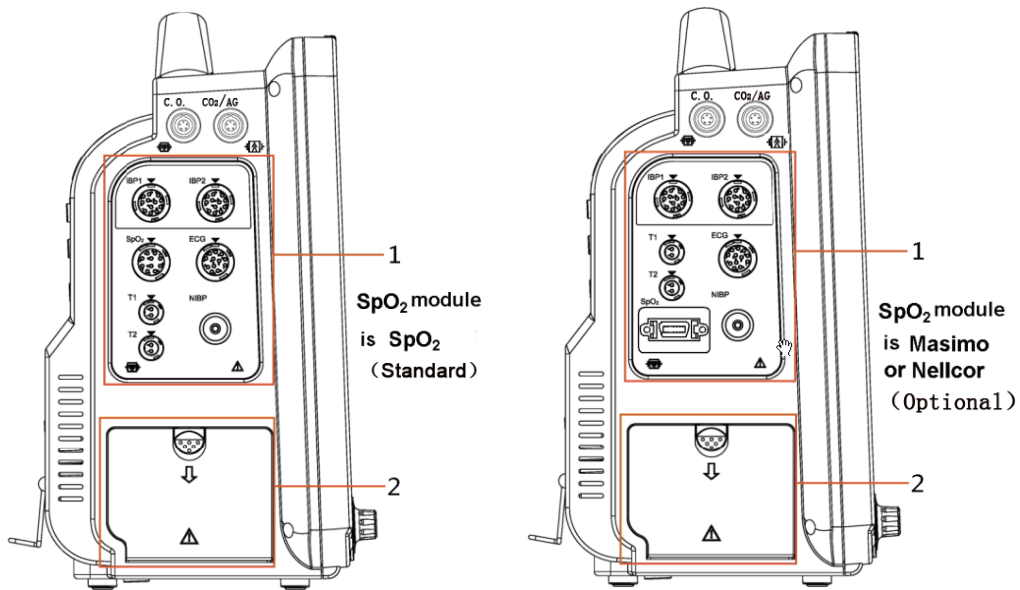

Figure 2.3 Left Side View of 12 Inches Monitor

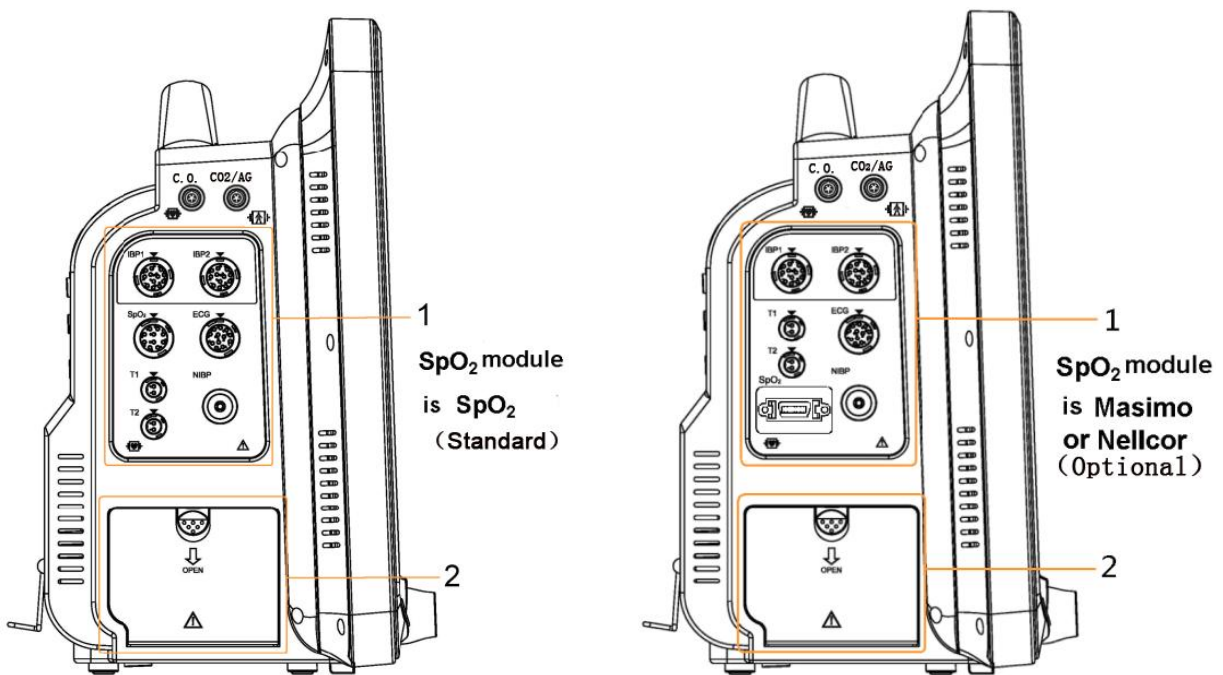

Figure 2.4 Left Side View of 15 Inches Monitor

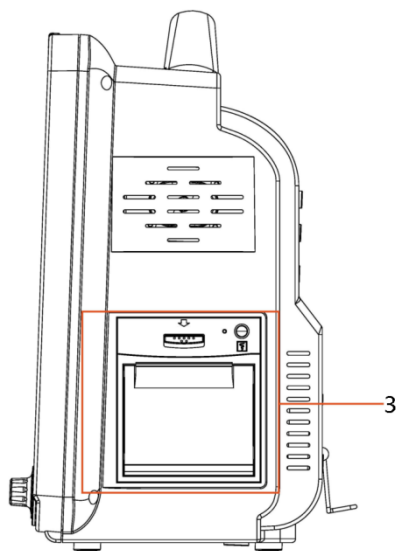

Figure 2.5 Right Side View of 12 Inches Monitor

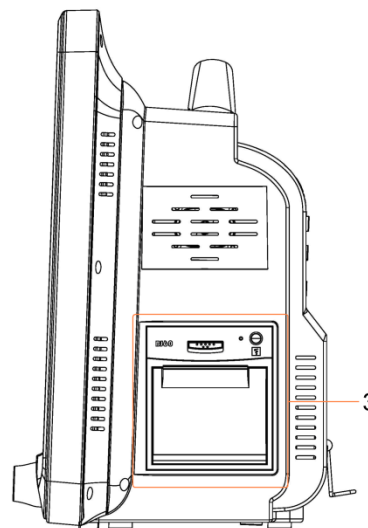

Figure 2.6 Right Side View of 15 Inches Monitor

For the convenience of operation, different interfaces are placed on different sections of the monitor. The cable and probe insertion points are placed on the left side of the monitor, as shown in Figure 2.3 (12 inches monitor) /2.4 (15 inches monitor).

The recorder is installed internally on the right side of the monitor, as shown in Figure 2.5 (12 inches monitor) /2.6 (15 inches monitor).

 **Explanation**

- All the side view structure below, please take the left picture in Figure 2.3/2.4 as example.

1. Parameter Interfaces

- IBP1, IBP2—invasive blood pressure interface.
- T1, T2—body temperature probe interface.
- NIBP— non-invasive blood pressure interface.
- SpO₂— blood oxygen saturation probe interface.
- ECG— electrocardiograph lead interface.

2. Battery Door

Two high-performance rechargeable lithium batteries can be installed.

3. Recorder

2.3.3 Back View

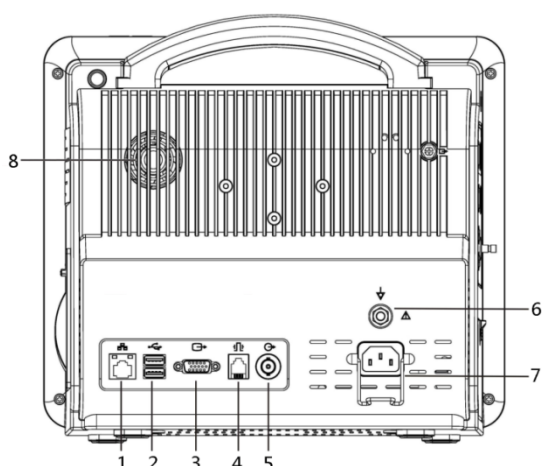

Figure 2.7 Back View of 12 Inches Monitor

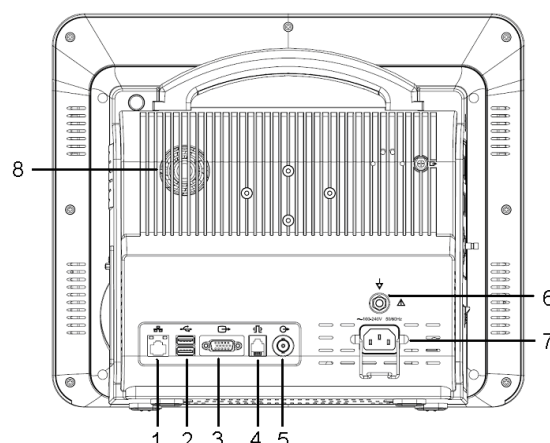

Figure 2.8 Back View of 15 Inches Monitor

The back faceplate contains the following insertions (as shown in Figure 2.7 (12 inches monitor) /2.8 (15 inches monitor)):

1	—Network interface	A standard RJ45 interface through which the monitor and a central monitoring system can be connected using a standard cable.
2	—USB interface	For online software upgrading, and export data through USB connection.
3	—VGA interface	For connection to an add-in display.
4	—Nurse call system interface and defibrillation synchronization interface	For connection to the call system of the hospital, through which to initiate nurse call signals when an alarm occurs, or to call nurse's attention. For connection to the defibrillator to carry on synchronized defibrillation.
5	—Analog output interface	For connection to devices such as an oscilloscope to put out analog signals.
6	—Isoelectric terminal	For synchronized use of the monitor and other devices; through which to overcome the potential differences between the monitor and another device, and to guarantee safety.
7	Power outlet	/
8	Ventilator	/

2.4 Modules

This series of monitors support the following modules:

Standard parameter modules: ECG, Resp, SpO₂, Temp and NIBP.

IBP modules (optional): the monitor supports two-channel IBP measurement.

CO₂ modules (optional): the monitor supports the products of Respironics, Phasein and Kingst.

Measurement methods include primary flow (outlayed) and by flow (inlayed or outlayed).

Anesthetic gas module (optional): Phasein (IRMA), Phasein (ISA).

2.5 Screen Display

2.5.1 Main Interface

This series of monitors use a colorful high-resolution TFT liquid crystal display screen, which can show the animal's physical parameters and waveform information. Figure 2.9 shows its standard interface under a normal monitoring condition.

Attention

- 12 inches monitor and 15 inches monitor have different layouts, this section 12 inches monitor screen display as an example.

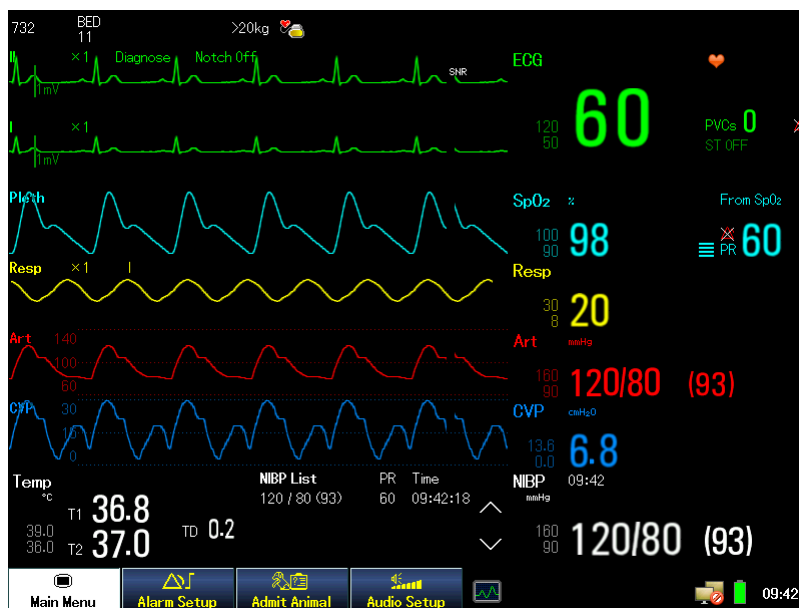



Figure 2.9 The Main Interface

2.5.2 Interface Explanation

◆ Animal's Informational Region

The information region lies at the top of the screen, which shows the department, bed number, Animal's name, animal type and pacemaker status in that order.

- Department: this can be set up in [User Maintain>>] - [Hospital Inf.>>]; without input, no information will be shown at this site.
- Bed number: it refers to the animal's hospital bed number, which can be set up at [Net Setup >>] in [User Maintain>>].
- Animal's name: it can be set up in [Animal Demographics]; without input, no information will be shown at the site.
- Animal type: it can be set up in [Animal Demographics]; without input, the animal will be defaulted as > 20 kg.
- Pacemaker status: it can be set up in [Animal Demographics]; if [Yes] is selected, the information will be shown ; if [No] is selected, the information will not show; [No] is defaulted by this series of monitors.

◆ Alarm State Graphical Presentation Region

-  Alarm pausing,  alarm silencing,  alarm sound off,  some parameter alarm off.

◆ Technical Alarm Region

Technical alarms and prompt information are shown in this region. When there are several pieces of information, they will be displayed in a cycle. When this region is selected, the menu of [Technical Alarm View] can be opened for checking information.

◆ Physiological Alarm Region

When the animal's parameters go beyond the range of the alarm limits preset in the monitor, alarm and prompt information will be displayed in this region. Several pieces of information will be displayed in a cycle. When this region is selected, the menu of [Review] can be entered.

◆ Waveform Region

Physiological parameter waveforms are displayed in this region.

The lead names are displayed at the left top of their corresponding waveforms. An electrocardio-wave displays the waveform gain and the electrocardio-wave filtering mode in its channel. To the right of the lead name, the gain rule strip is displayed. The respiratory waveform gain is displayed on the right of the respiration lead name. A window can pop up from the waveform region for menu operation.

◆ Data Region



Figure 2.10 Heart Rate and Temperature Data Region

- ✧ **ECG**: shows the current heart rate, e.g., 60 represents the current captured heart rate.
- ✧ **120/50**: the upper and lower heart rate alarm limits.
- ✧ **ST 0.08 I/ST 0.10 II**: the numerical value obtained from ST measure.
- ✧ **T1/T2**: body temperature identifications, e.g., “36.8, 37.0” are T1 and T2 body temperatures, respectively.
- ✧ **39.0/36.0**: the upper and lower limits of a body temperature alarm.
- ✧ **TD 0.2**: the gap between T1 and T2.



Figure 2.11 Respiration Data Region

- ✧ **Resp**: the respiration rate identification, e.g., “20” is the value of the respiration rate at the time of monitoring.
- ✧ **30/8**: the upper and lower limits of a respiration rate alarm.



Figure 2.12 Pulse oxygen Data Region

- ✧ **SpO₂**: the pulse oxygen identification, e.g., “98” is the value of the pulse oxygen saturation at the time of monitoring.
- ✧ **PR**: the pulse rate identification, e.g., “60” is the value of the pulse rate at the time of monitoring.
- ✧ **100/90**: the upper and lower limits of a blood oxygen alarm.



Figure 2.13 Non-Invasive Blood Pressure Data Region

- ✧ **NIBP**: blood pressure type identification.
- ✧ **Manual**: NIBP measure mode.
- ✧ **120/80/93**: values of measured NIBP contractive, diastolic and mean blood pressures.
- ✧ **160/90**: the upper and lower limits of an NIBP alarm.
- ✧ **16:35**: measure time.
- ✧ **▲ ▼**: up and down buttons for more NIBP information.

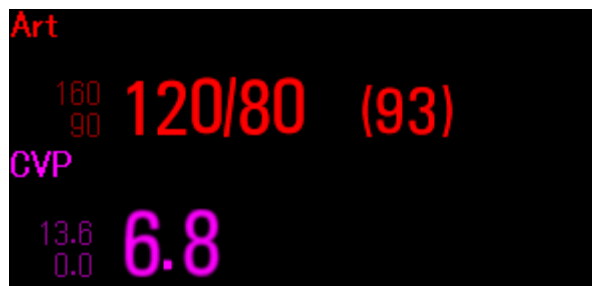

Figure 2.14 Invasive Blood Pressure Data Region

- ✧ **Art**: a blood pressure type identification
- ✧ **120/80/93**: the values of measured IBP contracture, diastolic and mean blood pressures.
- ✧ **160/90**: the upper and lower limits of an IBP alarm.
- ✧ **CVP**: blood pressure type identification.
- ✧ **6.8**: a measured value.
- ✧ **13.6/0.0**: the upper and lower limits of an IBP alarm.



Figure 2.15 CO₂ Data Region

- ✧ **CO₂**: end expiration carbon dioxide.
- ✧ **awRR**: the airway respiration rate.
- ✧ **Fi**: CO₂ intake.
- ✧ **Et**: the end expiration CO₂ concentration.
- ✧ **6.6/2.0**: the upper and lower limits of an end expiration CO₂ alarm.
- ✧ **5.0**: the measure value of end expiration CO₂.



Figure 2.16 Anesthetic Gas Data Area

- ◇ **MAC**: minimum alveolar concentration.
- ◇ **5.0/19.2/45/1.3/(0.3/1.6/21.2/50)**: CO₂, O₂, N₂O and AA end-tidal (Et) and respiratory (Fi) values.

◆ Prompt Information Region

The prompt information, network state icon, power supply state icon, and date and time are displayed in this region.

	A successful wired network connection		A successful wireless network connection
	An unsuccessful wired network connection		An unsuccessful wireless network connection
	Interface setup menu		Identification
	Battery identification		System time

◆ Menu region

Four shortcut keys are defaulted at the bottom of the screen: [Main Menu], [Alarm Setup], [Admit Animal] and [Audio Setup] (User can define the other 3 shortcut buttons in the shortcut region, in reference to the content of shortcut key in Section 2.6).

2.6 Shortcut Key

The following shortcut keys are defaulted on the screen:



User can customize the shortcut keys.

1. Select [Main Menu] – [System] – [Screen Setup] – [Screen Config], as shown in Figure 2. 17:

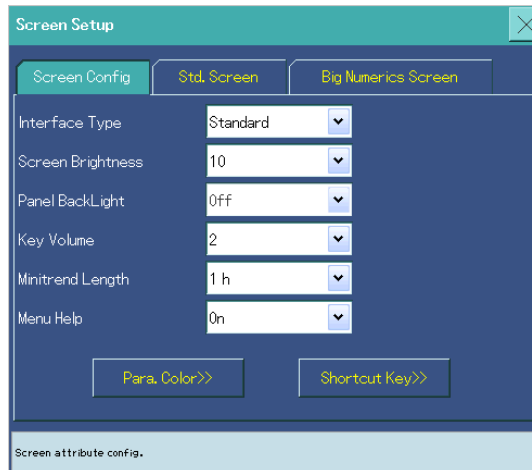

Figure 2.17 Screen Setup

2. Select [Shortcut Key>>]. You can select the displayed shortcut keys as well as arrange their order according to need in the current interface, as shown in Figure 2. 18:

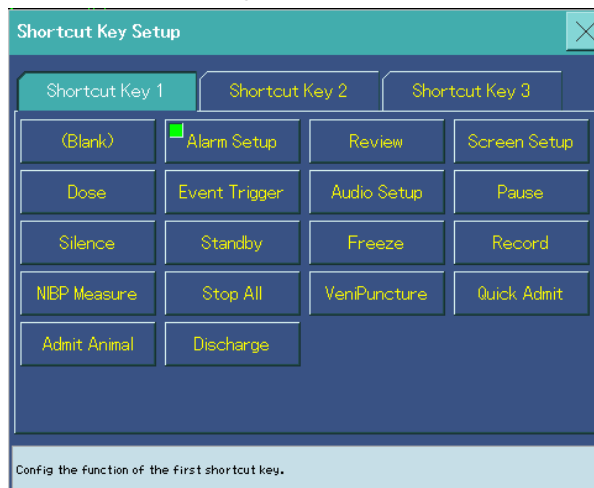

Figure 2.18 Shortcut Key Setup

Chapter 3 Basic Operation

3.1 Installation



Warning

- When this series of monitors are connected with other electric equipment for specific functional combinations, if safety cannot be assured based on their separate specifications, please contact the manufacturer or specialized experts in the hospital to secure that the necessary safety of any equipment in the combination won't be damaged.

3.1.1 Unpacking and Checking

1. Unpack the packing box, take out the monitor and accessories carefully, and put or install the monitor in a safe, stable and easily observable place.
2. Open the attached packing list, and count the accessories according to the inventory listed on it:
 - Check whether there is any mechanical damage.
 - Check all the leads, and insert some of them into accessories.



Attention

- Please keep the packing box and materials in case later transportation or storage is needed.
- If you find any problem, please contact the vendor or the company.



Warning

- Please keep the packing box and materials out of reach of children in case of asphyxia. In handling of the packing materials, you must observe the local laws and regulations or the hospital's stipulations on waste management.

3.1.2 Environmental Requirements

1. Avoid exposing the monitor to direct sunlight: avoid excessive temperature in the machine.
2. The monitor should not be operated in the atmosphere of noxious or easily flammable gas.
3. The monitor should be installed on a table stand in case of vibration.
4. The monitor should not be concurrently used with other equipment that is not included in the user manual.
5. Avoid water contact; avoid using the monitor at places with excessive air pressure, humidity or temperature beyond the stipulated standard, poor ventilation, excessive dust content, sulfur-, salt- or alkali-containing air, or chemicals.
6. Avoid keeping the monitor at chemical-storage places or places with a gas leakage risk.
7. The voltage and frequency of the supplied power source must satisfy the identifications indicated in the manual, and the power source must have sufficient electric capacity.
8. Place the monitor in a room with good facilities (such as the grounding facility).

3.1.3 Normal Operation Conditions

1. Operating temperature: 0 °C ~ 40 °C (32 °F ~ 104 °F). (If the machine includes CO₂ module, the operating temperature is 5 °C ~ 40 °C (41 °F ~ 104 °F)).

2. Operating humidity: 15%~80%, non-refrigerated.
3. Atmospheric pressure: 442.5 mmHg~805.5 mmHg (59 kPa~107.4 kPa).
4. Power source: AC 100 V~240 V, 50 Hz/60 Hz, frequency allowance ± 1 Hz; DC 14.8 V, 4.4 Ah.



Attention

- Transfer of the monitor from one environment into another may lead to condensation due to a temperature difference. Under such conditions, the monitor can be used again only after the condensation disappears.



Warning

- Please insure that the monitor is operated in a stable environment. Or, the technical specifications described in the manual may not be reached, or unanticipated consequences such as monitor damage may be caused.

3.2 Operation Preparation

3.2.1 A.C. Power Supply Connection

Please check the monitor and associated module states before A.C. power connection.

A.C. power connection procedures:

- Be sure that the current A.C. power satisfies the following specifications: AC 100V~240V, 50 Hz/60 Hz.
Use the power cord supplied with the monitor; insert one end of the cord into the power interface on the monitor, and the other end into a single-phase outlet with protective grounding.
- Use the specialized grounding wire supplied with the monitor to connect the monitor to the protective ground terminals.

Special attention: insure that the monitor has normal grounding.



Attention

- In order to use battery power, the batteries have to be charged after monitor transportation or storage. To turn on the monitor without an A.C. power connection, the monitor may not work normally due to insufficient power supplied by the batteries.
- This series of monitors are not suitable for connecting to CISPR11 provisions of public power.

3.2.2 Turn On

After the power source is switched on, after system self-examination the monitor enters the original monitoring interface. Then, the user can perform operations.

- Check all monitoring functions to be sure that they are normal.
- If batteries are equipped, charge the batteries after each time of use to insure that it has sufficient electric charge.



Attention

- If the monitor displays evidence of damage or an error prompt, stop using the monitor for Veterinary Monitoring. Please contact the vendor or the company.
- The interval between restarts should be more than 1 minute. Or, abnormal operation may be caused.

3.2.3 Sensor Connection

Connect the needed sensor to the monitor and the monitored body part of the animal.

Please refer to the associated sections in Chapter IV for more detailed information on sensor connection methods and requirements.

3.2.4 Recorder Checking

If this series of monitors have an internal recorder on the right side, check whether there is paper in the outlet. Please refer to Chapter 10 for recording information.

3.3 Monitoring

1. Decide what functions should be monitored or measured.
2. Install the required modules, animal cables and sensors.
3. Check whether the animal cables and sensors are the correct ones or not.
4. Check whether the monitor has been accurately set up.
5. Please refer to corresponding chapters and sections for various function measurements and monitoring.

3.4 Turn Off

Please shut down the monitor by following the following procedures:

1. Make sure that the monitoring for the animal has completed.
2. Disconnect the cables and associated sensors connected to the animal.
3. Make sure that Veterinary Monitoring and care data have been stored.
4. Press the power switch to turn off the monitor (shutdown time lag depends upon the preset by the manufacturer).



Attention

- A forced shutdown when normal shutdown cannot work or equipment power fails under special conditions may lead to monitoring data loss. Therefore, a forced shutdown is not recommended in normal circumstances.

3.5 Input Board

This series of monitors provide a input board for information input such as animal data.

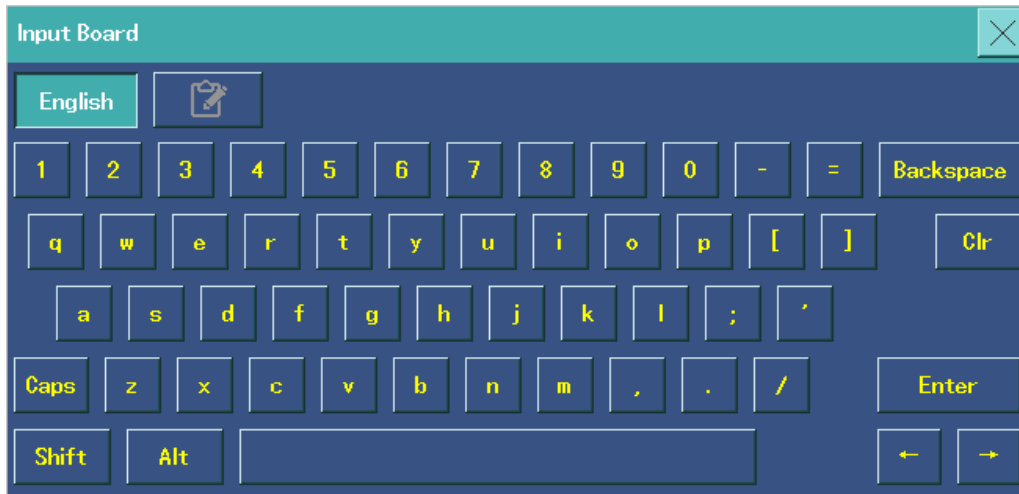

Figure 3.1 Input Board

[English]: Chinese-English switching.

[Backspace]: the preceding character delete.

[Caps]: uppercase and lowercase letter switching.

[Clr]: a clear key.

[Enter]: the confirmation key. Select this key to exit the user input faceplate interface.

[← →] the cursor left and right shift key.

3.6 Touch Screen (Optional)

If you select the optional touch screen function for your equipment, you may click the touch screen directly to accomplish some operations conveniently and quickly.

You can cancel or restore the touch screen feature as you need. To lock the screen, press the shuttle knob for 3 seconds, and  will appear at the bottom. To unlock, press the shuttle knob for 3 seconds again.

3.7 Interface Setup

Select the prompt information region  on the screen to enter [Screen Setup] as shown in Figure 3.2:

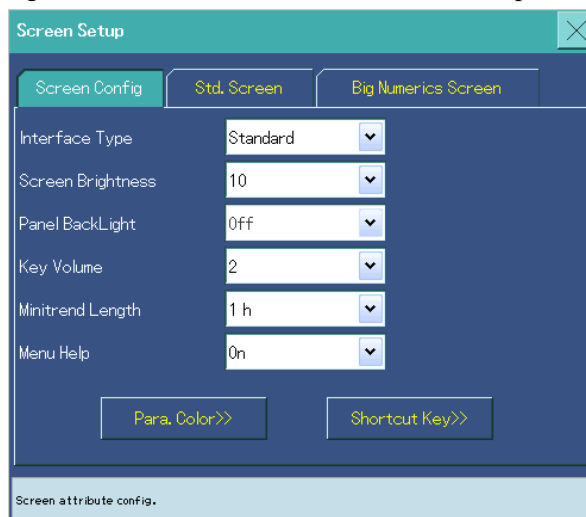

Figure 3.2 Screen Setup

In the standard interface layout window, the user can allocate positions to different parameters and waveforms. Those parameters and waveforms without allocated positions won't be displayed on the standard interface.

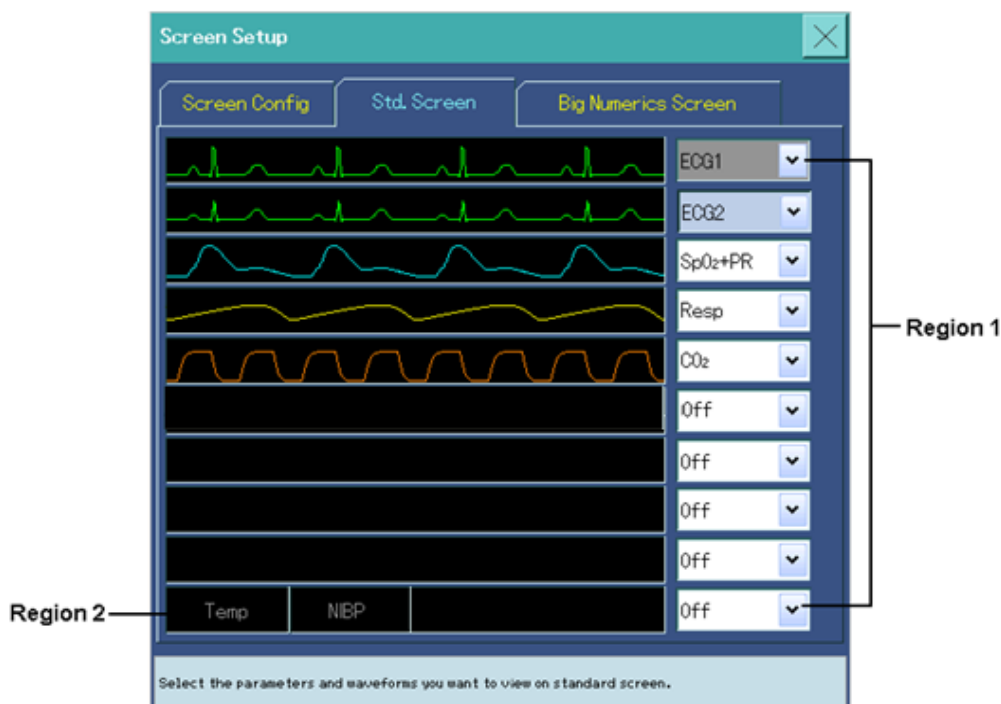

Figure 3.3 Standard Screen Layout Setup

Functions with displayed waveforms and their corresponding waveforms can be set up in Region 1. The corresponding waveform will be displayed on the left in the same row.

The last setup item in Region 1 shares the same position with Region 2 (i.e., Temp, NIBP list, NIBP, and Gas) on the main screen; the digital display module will be free layout On the bottom of the main screen. When the last item in Region 1 is not set as off, and Temp, NIBP parameter lists and gas will not be displayed on the main screen.

The system will arrange the current displayed waveforms automatically to achieve an optimal display effect.

When associated parameters or waveforms are not displayed on the interface after a module is added, please check:

- Whether the lead cable, cable, sensor or external add-in equipment has been well connected to the module.
- Whether there is the prompt that the associated parameter has not been turned on in the prompt region at the bottom of the screen. If there is such a prompt, please enter [Screen Setup] for the associated parameter and waveform setup.



Attention

- The most waveform of Standard Screen Layout Setup for 12 inches monitor is ten and the most waveform of Standard Screen Layout Setup for 15 inches monitor is eight. The Standard Screen Layout Setup in this chapter is as 15 inches monitor for example.

3.8 Main Menu

Select the Main Menu Shortcut key  on the screen, or press the Main Menu pushbutton on the monitor to open the main menu, as shown in Figure 3.4:

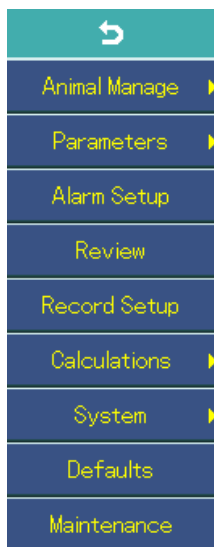

Figure 3.4 Main Menu

Most operations and setup of the monitor can be accomplished by operating in this menu.

3.9 General Setup

3.9.1 Monitor Definition

Select [Main Menu] – [Maintenance] – [User Maintain>>], and input the user maintenance password to set-up the monitor. Set up the hospital information, unit, time, alarm, network, default administration, touch screen calibration, CO₂ module maintenance and other information. Please refer to User Maintain in section 14.6 for detailed explanation.

3.9.2 Screen Type Setup

Select [Main Menu] – [System] – [Screen Setup], or press  directly to enter the screen setup. Select [Interface Type]: Standard, Minitrends, BigNumerics, OxyCRG, View Other Bed, 7 lead half, and 7 lead full. Please refer to User Interface in Chapter 5 for detailed information.

3.9.3 Screen Brightness and Panel Backlight Adjustment

Select [Main Menu] – [System] – [Screen Setup], or press  to enter the screen setup directly. Select [Screen Brightness]: 1 – 10.

Select [Main Menu] – [System] – [Screen Setup], or press  to enter the screen setup directly. Select [Panel Back Light]: On/Off.

3.9.4 Time and Date Setup

Select [Main Menu] – [Maintenance] – [User Maintain>>] – [Time Setup] to set up the year, month, day, hour, minute and second. After setup, press [Storage Time] to store the set time.

**Attention**

- Alterations in date and time may lead to animal data and events data lost.

3.9.5 Audio Setup**◆ Alarm Volume**

Select the [Audio Setup] Shortcut key, or [Main Menu] – [Alarm Setup] – [Global] to set [Alarm volume]: X – 10. X is the minimal volume (it depends on the preset minimal sound volume in the alarm configuration), and 10 is the maximum sound volume.

◆ Key Set Sound Volume

Select the [Audio Setup] shortcut key, or [Main Menu] – [System] – [Screen Setup], or press the screen to enter the screen setup interface. Select [Key Volume]: 0 ~ 10. Select 0 to turn-off the volume, and select 10 to turn up the volume to the maximum.

◆ Pulse Sound Volume

Select the [Audio Setup] shortcut key, or [Main Menu] – [Parameters] – [SpO₂ Setup] – [Pulse Volume]: 0 – 10. Select 0 to turn-off the volume, and select 10 to turn it up to the maximum.

◆ Key Set Tone

Select the [Audio Setup] Shortcut key to set the [Key Volume]: Default, Tone 1, Tone 2, and Tone 3.

◆ QRS Prompt Sound Volume

The QRS prompt sound volume is decided by the menu [Alm Source] in [ECG Setup] or [SpO₂ Setup]. When a parameter in [Alm Source] is set up, the QRS prompt sound volume will sound according to the rhythm of that parameter. During SpO₂ monitoring, the system also adjust the QRS pulse sound frequency according to SpO₂.

Select the [Audio Setup] shortcut key, and then select [Pulse Volume]: 0 – 10, or select [Main Menu] – [Parameters] – [ECG Setup] – [Others>>] – [QRS Volume]: 0 – 10. Select 0 to turn-off the volume, and 10 to turn it up to the maximum.

3.9.6 Help Menu

Select [Main Menu] – [System] – [Screen Setup] – [Screen Config] – [Menu Help]: On/Off. If On is selected, an explanation dialogue will be displayed; below the menu if off is selected, explanation will not be displayed.

3.10 Configuration Management**3.10.1 Recent Configuration Self-recovery**

The monitor carries out real-time configuration storage, which is the most recent configuration. When the device is off time does not exceed the user settings restore recently configuration time, after starting the apparatus automatically recover recently configuration.

**Warning**

- Accidental power failure may lead to the loss of settings.

3.10.2 Turning-on Default Configuration Setup

When the device is off time exceeds the user settings restore recently configuration time, after starting the apparatus will restore the configuration selected by a user.

Select [Main Menu] – [Maintenance] – [User Maintain>>], input the user maintain password, and then select [Defaults Manage>>] – [Select] to set up the valid time for recent configuration recovery and turning-on default configuration, as shown in Figure 3.5:



Figure 3.5 Defaults Manage



Attention

- To know the recovered start configuration, please look up the prompt information at the bottom of the screen after entering the main screen.

3.10.3 User Configuration Storage

The user can adjust this series of monitors configurations according to need, and store them as the user configurations. The monitor can store four user-defined configurations at most. The configuration names and types can be self-defined.

Select [Main Menu] – [Maintenance] – [User Maintain>>], input the user maintain password, select [Defaults Manage>>] – [Add] to fill in the configuration information (including the self-defined configuration name and type, in which the configuration type is identical to the animal type). After filling in the information, select [Save] to store the self-defined configuration.

The stored configuration name in the system is presented as Name + Animal Type + Configuration. For example, if the self-defined configuration name is ICU, and the animal type is “>20 kg”, the stored configuration name is ICU >20 kg Configuration.

3.10.4 User Configuration Deletion

The user can delete the self-defined configurations according to actual need.

Select [Main Menu] – [Maintenance] – [User Maintain>>], input the password, and select [Defaults Manage>>] – [Delete] to select the configuration you want to delete; or select [Select All] – [Delete], and then select the button [OK] after a dialog is displayed to delete the user self-defined configuration. The function of the button [Reset] is to restore the selected configuration to an unselected state and then to reset the configuration the user wants to delete.



Attention

- The system default configuration cannot be deleted.

3.10.5 Default Configuration Manual Restore

Restore some default configurations according to the following procedures:

Select [Main Menu] – [Defaults], select the company configuration or user configuration according to the animal type, select [Resume], and then select [OK] after the window is displayed to restore the selected default configuration model.



Attention

- Default configuration recovery may change all the current setups and layout.

-- The Blank Page --

Chapter 4 Animal Management

4.1 Admit Animal

1. Select [Main Menu] – [Animal Manage] – [Admit Animal].
2. If the monitor displays a warning screen, press [Yes] to continue.
3. Input and select all information into the menu [Animal Demographics].
4. Select [OK] to complete the animal information input.



Attention

- [Animal Cat.]: > 20 kg, 10~20 kg, and < 10 kg Different animal types determine different calculation methods of the monitor as well as safety and alarm limits of some measures.
- [Paced]: If select [Yes], and the monitor detects pacing signals, the pacing pulse marker will be displayed above the ECG waveform.



Warning

- No matter whether the animal is accepted or not, the system will give [Animal Cat.] and [Paced] a default value for each. The user must make sure whether the value is applicable to the animal or not.
- For animals wearing a pacemaker, [Paced] must be set to [Yes]. Or, the pulse may be treated as routine QRS groups. As a consequence, the system cannot detect when to alarm when ECG signals are too weak.
- For non-pacemaker animals, [Paced] should be set to [No]. Or, the system cannot detect ventricular premature associated arrhythmias (including PVCs counts).

4.2 Quick Admit

When you have no time to fill in the animal's detailed information in a special or urgent situation, adopt the quick animal acceptance model. The complete detailed information can be filled in later.

1. Select [Main Menu] – [Animal Manage] – [Quick Admit].
2. If the monitor displays a warning screen, follow-up the on-screen information, press [OK] to continue.
3. Set up [Animal Cat.] and [Paced], and then select [OK].

4.3 Edit Animal Demographics

When the animal's information needs to be altered:

1. Select [Main Menu] – [Animal Manage] – [Animal Demographics].
2. Fill in or set up the animal's detailed information in the [Animal Demographics] menu.
3. Select [OK] to finish the animal information input.

4.4 Discharge Animal

1. Select [Main Menu] – [Animal Manage] – [Discharge Animal].
2. After [Discharge Animal] is selected, you can operate as follows in the selected menu:
 - Select [OK] rather than [Standby], and the monitor will carry out animal removal operation. After removal, it returns to the main screen.

- Select [Standby] – [OK], the monitor will carry out animal removal operation, and then enter a standby mode. Exit the standby mode by pressing any key.
- Select [Cancel], the monitor may exit from the animal removal operation, and then return to the main screen.



Attention

- The operation of animal removal will clear all the historical data in the monitor.

4.5 Data Management

1. Select [Main Menu] – [Animal Manage] – [Data Management].
2. After [Data Management] is selected, you can operate as follows in the selected menu:
 - Data Export: after you select the file type, the animal data can be exported to the U disk memory. The file types are data files and Config Files, users can select anyone of them or select all to export.



Note

- Do not power off when data importing/exporting, or it may cause the data disorder even lost.
- Because the system time is different between monitors and monitors, Import animal data may be interleaved with native data on time.

4.6 Central Monitoring System

This series of monitors can be connected to a central monitoring system. Through the network:

- The monitor can send the animal information, monitoring or measure data, alarm limits, alarm levels, alarm information, prompt information, and various setups to the central monitoring system.
- The central monitoring system and monitor can display the information in both places, and control some functions bidirectional.

For more detailed information, please refer to the user manual of the central monitoring system.

Chapter 5 User Interface

5.1 Interface Style Setup

The user can set up the interface style according to need, including waveform tracing methods, parameter color, monitor parameter setup, screen setup, interface layout, etc.

◆ Waveform Tracing Methods

Select [Main Menu] – [Maintenance] – [User Maintain>>] – password input – [Other Setup>>] – [Curve Draw] to set up the tracing method for waveforms displayed on the screen. The tracing methods include ladder and color steps. You may select the thickness of the line in this interface.

◆ Screen Setup

Select [Main Menu] – [System] – [Screen Setup], or press the screen setup Shortcut key to enter the interface [Screen Setup].

In this window [Screen Config], you can set interface type, screen brightness, panel backlight, etc.

In the window [Std. Screen], you can set the content in the parameter and waveform regions. For more detailed information about screen setup, please refer to the Interface Setup section in 3.7.

In the window [Big Numerics Screen], you can select the large font interface to highlight the needed parameters and waveforms.

◆ Parameter Color

Select [Main Menu] – [System] – [Screen Setup], or press the screen setup shortcut key to enter the interface [Screen Setup]. In this window, select [Para. Color>>]. Then, select the color box on the right side of the waveform and parameter, and select your needed color in the pop-up menu.

◆ Shortcut Key

Select [Main Menu] – [System] – [Screen Setup], or press the screen setup shortcut key to enter the interface [Screen Setup]. Select [Shortcut Key>>] in the current window, and you may then set up the three shortcut keys displayed at the bottom of the screen according to need.

5.2 Standard Interface

Select the [Screen Setup] – [Screen Config] – [Interface Type] – [Standard]. Parameter-labeled waveforms are displayed on the left of the screen, and parameter data regions are displayed on the right, as shown in Figure 5.1:

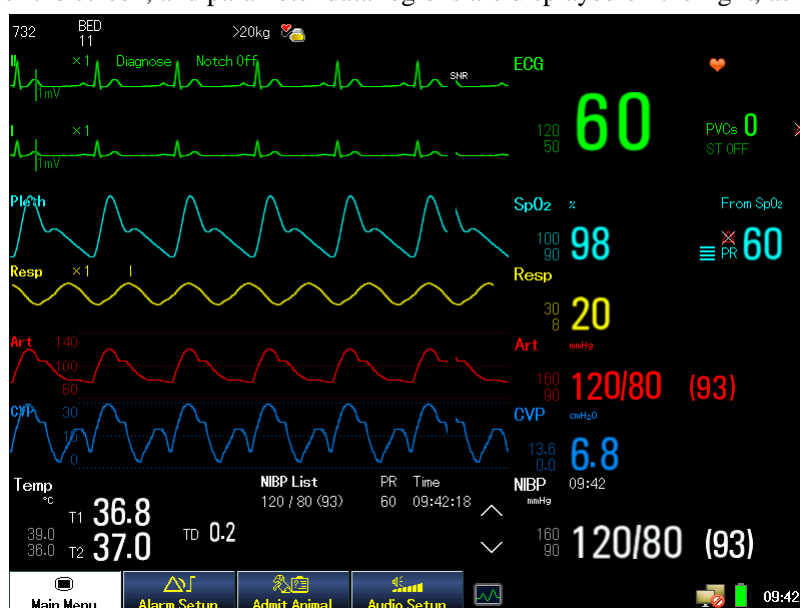

Figure 5.1 Standard Interface

The user can select the needed parameter labels according to need in the [Std. Screen] menu.

5.3 Minitrends Interface

Select [Screen Setup] – [Screen Config] – [Interface Type] – [Minitrends]. The short trend is displayed on the left of the waveform region, and shows the trend of the parameter in the recent time period, as shown in Figure 5.2:

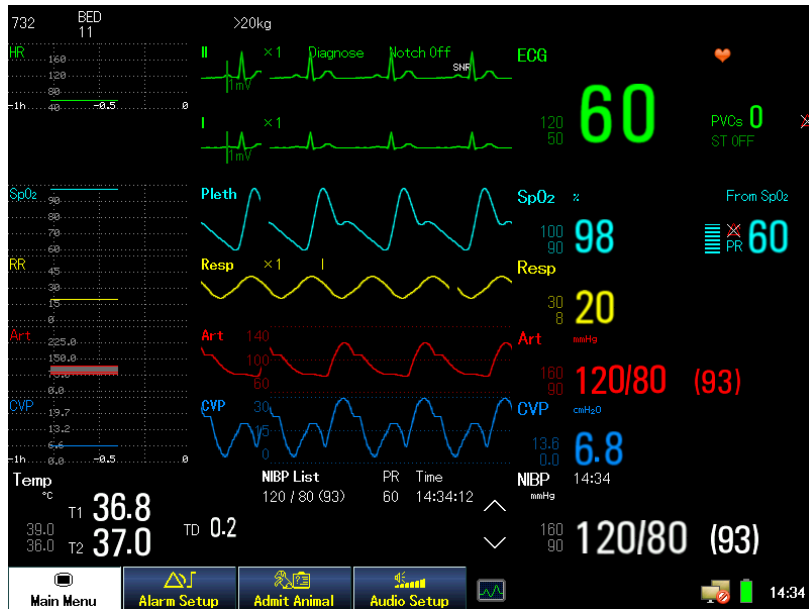

Figure 5.2 Minitrends Interface

In each minitrends, the parameter label is shown at the top, the scale is shown on the left, and the timescale is shown at the bottom, as shown in Figure 5.3:

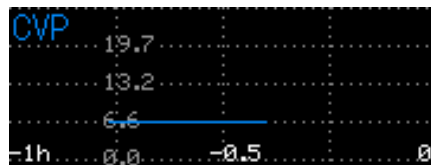

Figure 5.3 Minitrends of Parameter

5.4 BigNumerics Interface

Select [Screen Setup] – [Screen Config] – [Interface Type] – [BigNumerics]. The big numerics interface is shown in Figure 5.4:

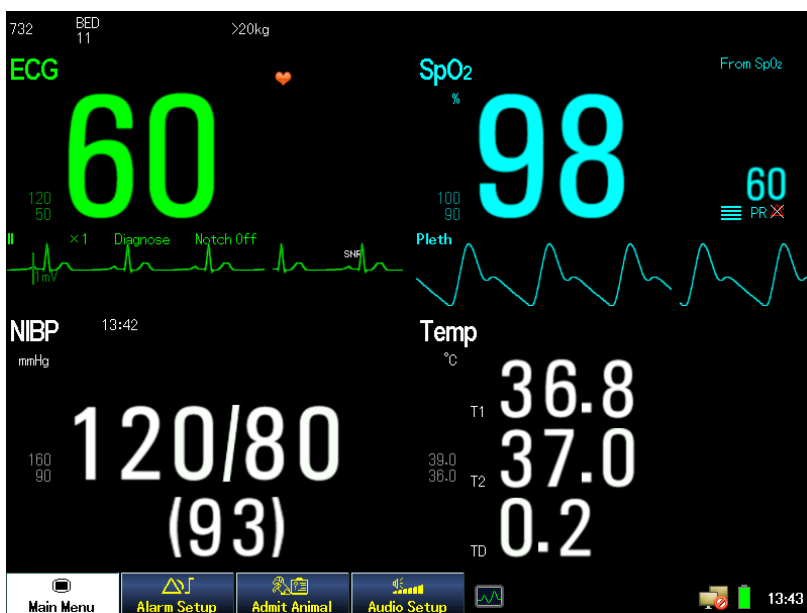

Figure 5.4 BigNumerics Interface

5.5 OxyCRG Interface

Select [Screen Setup] – [Screen Config] – [Interface Type] – [OxyCRG], which is shown in Figure 5.5:

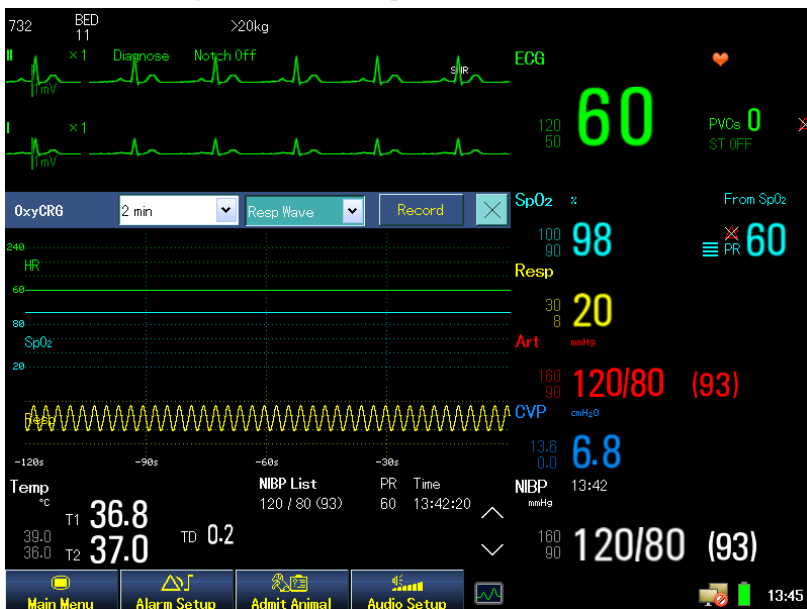

Figure 5.5 OxyCRG Interface

In this interface, you may select the time range and RR Trend /Resp Wave gram of the respiratory oxygenation graph, as shown in Figure 5.6:

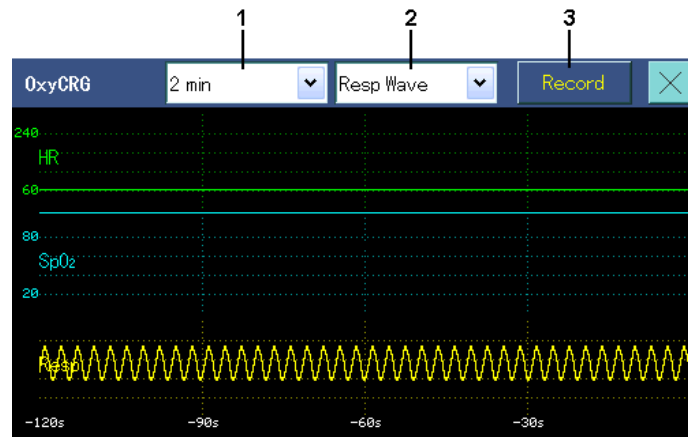

Figure 5.6 OxyCRG Setup

1. Trend time length: [1 min], [2 min], [4 min], or [8 min].
2. Resp Wave/RR Trend: the Resp wave or RR trend can be displayed.
3. Record: the current respiratory oxygenation gram can be printed through a recorder.

5.6 View Other Bed Interface

Select [Screen Setup] – [Screen Config] – [Interface Type] – [View Other Bed], which is shown in Figure 5.7:

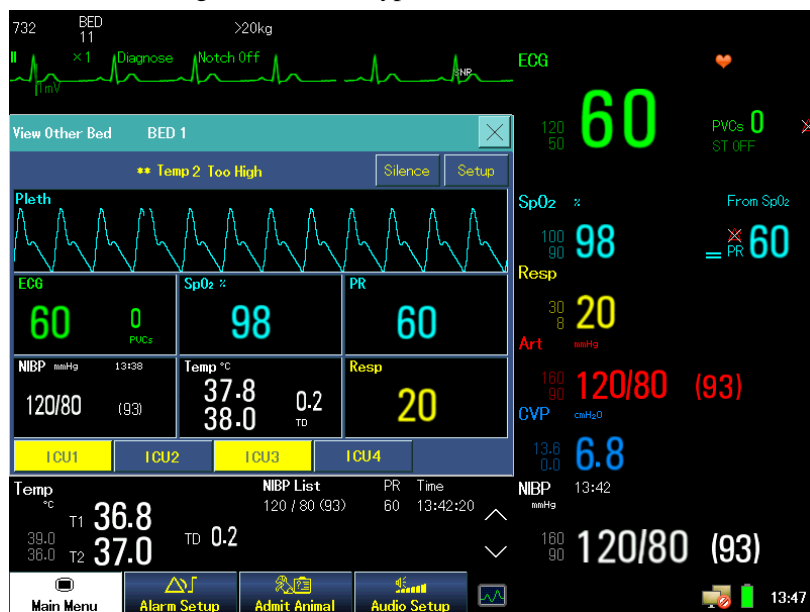

Figure 5.7 View Other Bed Interface

◆ Other Bed Set

This series of monitors can select five monitors at most in the same network to form an ‘Other Bed Set’. The realization of the set depends on that the monitor and other monitors that have the same group field in [Local IP] of [Net Setup>>]. Select [Setup] in the [View Other Bed] window, and an [Other Bed Setup] window will pop up, as shown in Figure 5.8. Select the needed connected monitors from the lists in the window, and then select [Exit] to start the function of other bed observation.



Figure 5.8 Other Bed Setup Window

◆ View Other Bed Window

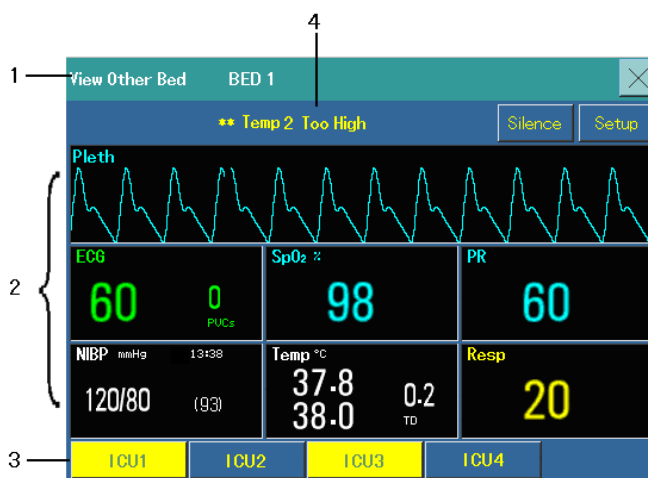

Figure 5.9 View Other Bed Window

When the View Other Bed window is opened for the first time, the monitor will select other bed monitors automatically for observation. The window occupies the region below the waveform region, and is composed of:

- 1 Information row: including the divisions, bed numbers, animals' names and animal types of the other beds.
- 2 Observation region: showing some of the physiological waveforms and parameter data of the other bed monitors.
- 3 Other bed set column.
- 4 Other bed information region: displaying physiological and technical alarms. Select this region to open [Other Bed Alarm Information] for observation of all alarm information of the other beds.

In addition, you may select waveforms and parameters for observation according to need:

- Select some waveform region, and then select the needed waveform label in the pop-up menu [Waveform Region Selection].
- Select some parameter region, and then select the needed parameter label in the pop-up menu [Parameter Region Selection]. You may also select [Waveform Region Switching] for waveform region observation.

 Attention

- When a parameter in the parameter region has no waveform display, the item Waveform Region Switching will not be available in Parameter Region Selection.

 Warning

- As the data display in the other bed observation window has some time delay, don't depend on this window to acquire real-time data.

◆ Other Bed Set Column



Figure 5.10 Other Bed Set Column

The column is located at the bottom of the [Other Bed Observation] window, displaying the divisions and bed numbers of the other bed monitors. Its state is indicated by different colors.

- Red: indicating a high-level physiological or technical alarm for this series of monitors.
- Yellow: indicating a moderate- or low-level physiological or technical alarm for the monitor.
- Blue: indicating a low-level technical alarm for the monitor.
- Gray: indicating an unsuccessful network connection or a standby state for the monitor.

By selecting a monitor in the other bed set column, you can:

- Observe the current alarm of the monitor.
- Observe the monitor.

For more detailed content about other bed alarms, please refer to the Other Bed Alarm section in 7.11.

5.7 C.O. Measure Screen (Optional)

Select [Screen Setup] – [Screen Config] – [Interface Type] – [C.O. Measure], as shown in Figure 5.11:

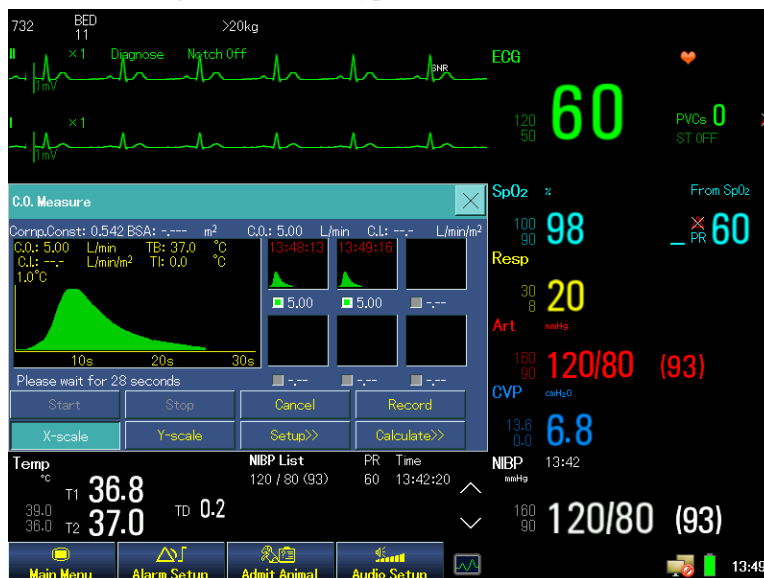

Figure 5.11 C.O. Measure Interface

For more detailed content about C.O. Measure, please refer to the C.O. section in 6.9.

5.8 7 Lead Half Screen

Select [Screen Setup] – [Screen Config] – [Interface Type] – [7 Lead Half], as shown in Figure 5.12:

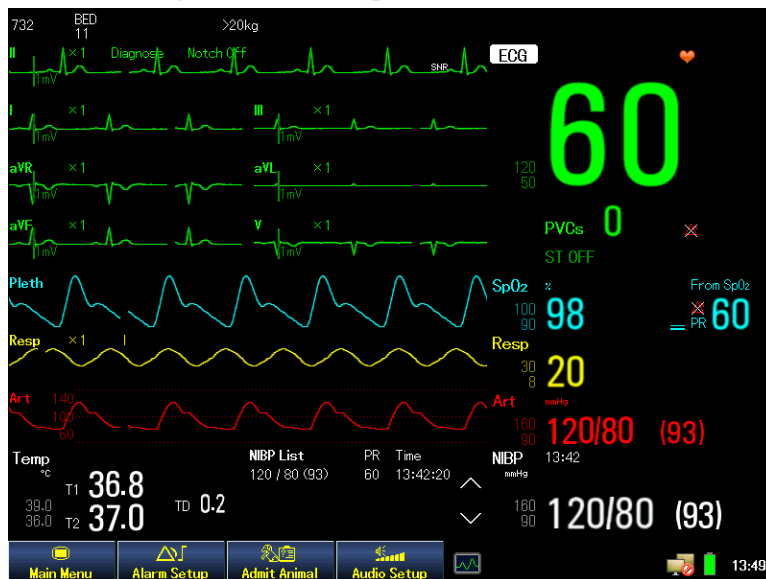

Figure 5.12 7 Lead Half Interface

5.9 7 Lead Full Screen

Select [Screen Setup] – [Screen Config] – [Interface Type] – [7 Lead Full], as shown in 5.13:

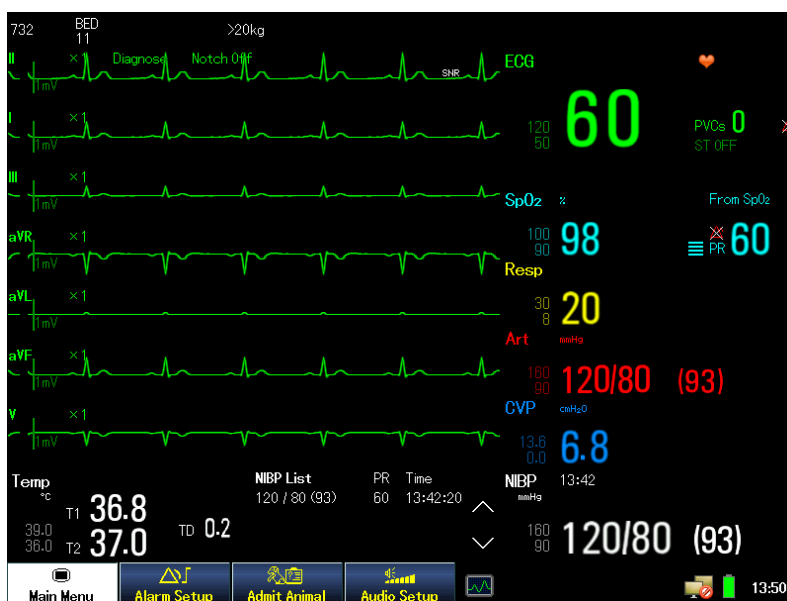

Figure 5.13 7 Lead Full Interface

-- The Blank Page --

Chapter 6 Parameter Monitoring

6.1 ECG

6.1.1 ECG Measuring Principle

I. Brief Description of ECG

The heart has its own special electrical conduction system. It is situated within heart walls and consists of specially differentiated myocardial cells. The function is generating and conducting excitations, and maintaining and governing normal heart rhythms. The cardiac conduction system consists of atrionector, internodal tracts, atrioventricular bundles, atrioventricular junctions, Kent-His bundles, bundle branches and Purkinje's fibers, as shown in Figure 6.1:

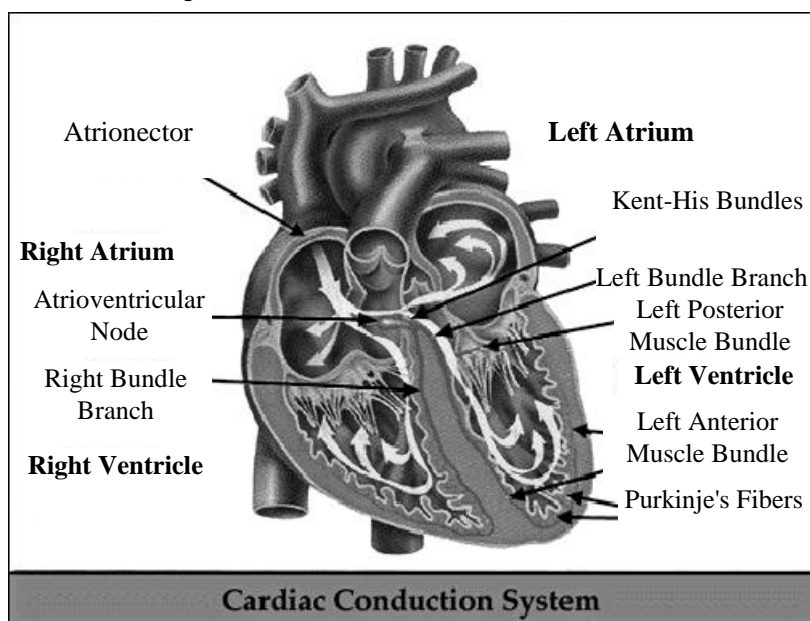

Figure 6.1 Special Cardiac Conduction System Diagram

The myocardium is constituted of innumerable myocardial cells, atrionector generates an excitation, which conducts toward the atrium and ventricle to cause progressive excitations of the entire heart in accordance with certain pathways and time interval. The changes of electrical potentials in the direction, pathway, sequence, and time in the process of excitation of each part of the heart follow a certain rule. Since a body is equivalent to a volume conductor, these electrical changes will eventually spread to the body surface. Given that a great number of electrical signals are generated by the heart at the same time, they can be recorded as functions of time through electrodes that are placed on the surface of the chest or limbs, and this recorded curve is called electrocardiogram (ECG). Electrocardiograph (ECG) is a representation of changes of bioelectricity in the process of generating, conducting and recovering excitations of the heart. The changes of bioelectricity of myocardial cells are the source of ECG.

ECG is an abbreviation for electrocardiogram. A normal ECG includes P-waves, QRS complexes and T-waves. A P-wave is originated from the potential change when the atrium depolarizes before its contraction. A QRS complex is originated from the potential change when the ventricle depolarizes before its contraction, and a T-wave is originated from the potential change when the ventricle repolarizes, the amplitude of T-wave should not be lower than 1/10 of that of R-wave in the same lead, T-wave is abnormal which means Myocardial ischemia or damage.

II. Testing Method

This series of monitor measure ECG waveform and data by body surface potential mapping method.

Body surface potential measure is recorded by placing several electrodes on chest and back, and simultaneously record ECG waveforms from each electrode site at each sampling moment. Since over 200 electrodes are used to measure the body surface potentials, this method can provide the cardio electric potentials of a great many sites on the body surface, which allows a full view of the cardio electric field on the entire body surface and the profile of the electrical cardiac activities for the whole cardiac cycle (especially P-waves, QRS complex and T-waves). In addition, it can also plot extreme locus diagram as an representation of motion locus of cardio electric maximum and minimum values within a given cardiac interval.

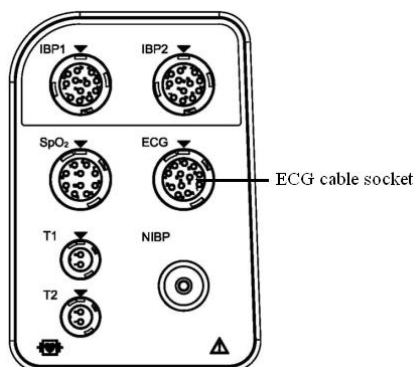

Figure 6.2 ECG Cable Socket

6.1.2 Definition of ECG Monitoring

ECG Monitoring is aimed at precisely evaluating the current physiological conditions of an animal by producing continuous waveforms of his/her cardio electric activities. To this end, normal connection of the cardio electric lead cables should be guaranteed in the interest of accurate measured values.

The animal cable is comprised of two parts:

- The trunk is the connection with the monitor and lead equipment to animals.
- Parameters displayed on the monitor include: heart rate (HR), ST segment measured value and arrhythmia.

6.1.3 ECG Intended Use

- Diagnostic of this series of ECG monitor's application include: check the cardiac abnormalities of the general population, check the chest pain in animals with acute myocardial ischemia and myocardial infarction, check animals with arrhythmias;
- Suitable for: Vet > 20 kg, Vet from 10 to 20 kg, and Vet < 10 kg;
- Used in: hospitals, clinics;
- Automatically analyze accuracy of this series of ECG monitor of the focus is check the high sensitivity of high-risk animals with unusually heart.

6.1.4 Safety Information



Warning

- It should be guaranteed that no electrode or cable that is being connected comes in contact with other conducting parts or grounding and that all ECG electrodes are connected to the body surface of the animal.
- Skin where electrodes are placed should undergo regular checks, and electrodes should be changed or replaced in case of any allergy.

- Non-defibrillation ECG cables are prohibited for use when defibrillation is needed for animals.
- During defibrillation, contact with animals, desks or instruments is NOT allowed.
- Interference caused by ungrounded instruments around the animal and ESU interference may result in distorted waveforms.
- Appropriate electrodes should be used; a large electrical potential deviation may be produced when some electrodes are polarized. Spherical electrodes during ECG recording produce a polarization effect more easily.
- Electrodes should be appropriately used and placed by following guidance from the manufacturer. The display screen can be restored as normal 10 sec after the defibrillation.
- The monitor runs abnormally when either the monitor is overloaded or any of its amplifiers are saturated.
- The electrode cannot be used in different metal materials. The electrode and electrode plate should be the same model.

6.1.5 Monitoring Procedures

◆ Basic Steps

1. Examine the animal's skin before attaching electrodes. (Skin is a poor conductor, so the skin preparation of animals is highly important to achieve the desired contact between electrodes and skin.)
 - ◀ Wash skin with soap and water. (ether and pure alcohols are not allowed because there may result in an increased impedance of skin)
 - ◀ Wipe-dry skin to increase blood flow of the blood capillaries and then remove hair and oil from the skin.
2. Place electrodes on the animal body. If conductive paste-free electrodes are used, please put conductive paste onto the electrodes before placing.
3. Connect electrode leads and animal lead cables.
4. Connect one end of the cables to the ECG cables socket of the monitor.
5. Switch on the monitor.



Attention

- ECG patch should be checked for skin allergy. Electrodes should be changed or re-placed if an allergy is found. Normal connection of leads must be checked before monitoring. The prompting message: ECG Lead Disconnect is displayed when leads are unplugged or separated or the RL is separated; and the prompting message ECG xx Lead Off is displayed when the RL is connected normally while other ECG leads are not connected.

◆ Lead Selection

1. Select [Main Menu]-[Parameters]-[ECG Setup] or select ECG Parameter Region or Waveform Region to open the menu [ECG Setup].
2. Enter [Others>>] and set the [Lead Set] as [3-Lead], or [5-Lead] depending on desired leads.

◆ Electrode Placement

ECG measure is collecting electrocardio signals by connecting ECG cables with the monitor, and connected with the animal via electrodes. Therefore, the position of the electrodes on the animal is very important.

Table 6.1 Comparison for the Color of Electrodes and Cable

Lead		European Standard		U.S. Standard	
Electrode Position	Cable Colour	Marking	Electrode Colour	Marking	Electrode Colour
Right Arm	Gray	R	Red	RA	White
Left Arm	Gray	L	Yellow	LA	Black
Right Foot	Gray	N or RF	Black	RL	Green
Left Foot	Gray	F	Green	LL	Red
Chest	White	C	Red	V	Red

In order to detect the electrocardio signals of animals, electrodes should be properly adhered to animals. The ECG lead cable is connected so that its one end is inserted into the ECG/Resp socket on the left panel of the monitor. When the monitor is powered on, if the electrodes are not properly attached or become separated from the monitor during monitoring, the monitor will display the message: **“ECG Lead Disconnect or ECG xx Lead Off”** to prompt medical staff.

5-Lead (Standard)

Positions of lead electrodes are shown as Figure 6.4:

- RA: below the clavicle close to the right shoulder
- LA: below the clavicle close to the left shoulder
- LL: lower left abdomen
- RL: lower right abdomen
- V: the positions of V lead are shown as following:

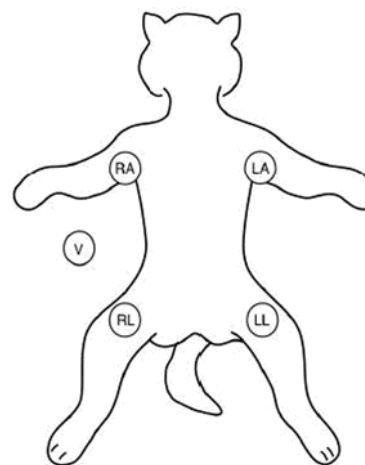

Figure 6.3 Placement of 5-Lead Electrodes



Attention

- Use of electrode patches by animals should be immediately discontinued if any skin allergy or irritation takes place; and the use of electrode patches by animals having skin inflammatory disorders or infected skin is NOT allowed.

Electrode Placement for Surgical Animals

Electrodes should be placed for surgical animals by taking into consideration the type of operation. For example, chest electrodes can be placed on flanks or backs for thoracotomy animals. In addition, in the case where a surgical electrotome is used, electrodes can be placed on the right and left shoulders close to the right and left abdominal sides and the chest leads on the left side relative to the chest median so as to reduce the effect of artifact on ECG waveforms. You should avoid placing electrodes on the arms; otherwise, ECG waveforms will have invisible amplitudes.



Warning

- ECG electrodes are placed between the electrosurgical equipment grounding plate and electrosurgical knife to prevent burning when electrosurgical equipment is in use. Electrosurgical equipment cables should not be twisted with ECG cables.

- Electrodes are strictly prohibited from being placed close to the electrosurgical equipment grounding plate when electrosurgical equipment is in use. Otherwise, ECG signals will be severely affected.

◆ Check on Pacemaking Status

Prior to ECG monitoring, it is important to correctly set animal's pacemaking status. When [Paced] is [Yes],  will be displayed. When the system detects pace-making signals, the icon 'P' will be displayed.

Users can reset pace-making status:

Select Animal Information Region - [Animal Demographics] - [Paced] or Select [Main Menu] - [Animal Manage] - [Animal Demographics] - [Paced], or enter [ECG Setup] from ECG Parameter Region and select [Others>>]-[Paced].



Warning

- When the animal is wearing a pacemaker, 'Paced' should be set to [Yes], if not, set to [No].
- The paced pulse analysis function should be activated for pace-making animals. Otherwise, the pace-making pulses may be counted as normal QRS complexes, resulting in abnormal HR computation.

6.1.6 ECG Display

The default interface of the monitor is 5-lead interface, as shown in Figure 6.7 for reference of an ECG waveform on 5-lead interface.

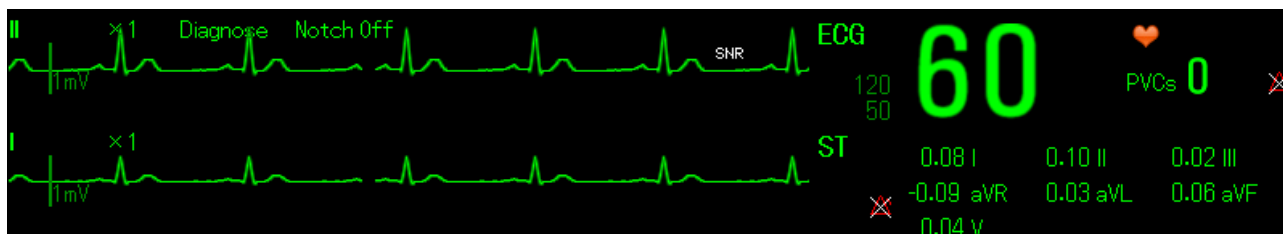

Figure 6.7 ECG Display

ECG Waveform Rhythm State on Figure 6.7: Sinus Rhythm.

If the [Paced] is set [Yes], the pace-making symbol will be displayed above the ECG waveform when the monitor detects pace-making signals.

6.1.7 ECG Setup

◆ Open ECG menu

Methods to Open [ECG Setup]:

- Select [Main Menu]-[Parameters]-[ECG Setup].
- Select ECG waveform region and open [ECG Setup].
- Select ECG parameter region and open [ECG Setup].

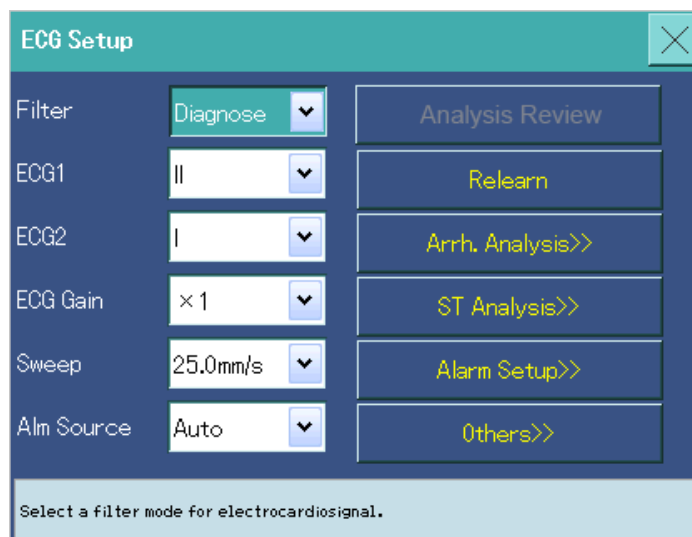

Figure 6.8 ECG Setup

◆ **Filter Mode Setup**

Open the menu [ECG Setup] and select [Filter]:

Diagnose: for diagnostic quality requirements.

Monitor: for normal measure.

Surgery: for occasions where signals are interfered with. Select surgery mode to reduce interference from electrosurgical equipment and other sources.

◆ **ECG Lead Setup**

Open the menu [ECG Setup] and select [ECG]: I, II, III, aVR, aVF and V. Select ECG waveforms from an optional channel and if two-channel waveform selection is available, lead 1 and 2 can be mutually replaced when one lead is duplicating the other.

◆ **Waveform Gain Setup**

Open the menu [ECG Setup] and select [ECG Gain]: $\times 1/8$, $\times 1/4$, $\times 1/2$, $\times 1$, $\times 2$, $\times 4$ and Auto. ECG waveform gain can be selected to meet different requirements.

◆ **Waveform Sweep Speed Setup**

Select [Sweep] in the menu [ECG Setup]: 6.25 mm/s, 12.5 mm/s, 25.0 mm/s and 50.0 mm/s.

◆ **Alarm Source Setup**

In most cases, numeric value of heart rate (HR) and pulse rate (PR) are the same. The monitor can select either as its alarm source, so that alarms of heart rate and pulse rate are given at the same time. To reset alarm source, select [Alm Source] in the menu [ECG Setup]: HR, PR and Auto.

HR: Heart Rate as HR/PR alarm source.

PR: Pulse Rate as HR/PR alarm source.

Auto: when ECG measure is started and effective HR is obtained, the monitor will use ECG-derived heart rate as its alarm source. In case heart rate is not available, e.g. when leads are not connected and there has been one pulse source that is useable, the monitor will automatically use the pulse rate derived from the current measure as the pulse source that is used as its alarm source. The monitor will then automatically reuse the heart rate as its alarm source if the heart rate is obtainable.

◆ **Analysis Review**

Select this Option to enter analysis review interface.

◆ **Alarm Setup**

Select [Alarm Setup>>], and [PAR.Alarm] will automatically pop up: HR/PR: which enable setting of on/off of alarm switches, high and low alarm limits, alarm level, and whether or not to open the alarm record.

◆ Other Setup

Select [ECG Setup]-[Others>>]:

QRS Volume: 0-10.0 and 10 indicate mute and the maximum volume, respectively.

Notch Filter: when the Filter Mode is 'Monitor' or 'Surgery', the notch filter is defaulted open (50Hz or 60Hz); when the Filter Mode is 'Diagnose', the notch filter can be opened or closed to meet different demands.

Lead Set: 3-Lead, and 5-Lead.

Screen: select ECG working interface, and different options are available for different [Lead Set] settings:

- 1) 3-Lead: Normal.
- 2) 5-Lead: Normal, 7 Lead Half and 7 Lead Full.

Paced: please refer to Check on Pacemaking Status for more details.

Save Curve: I, II, III, aVR, aVL, aVF and V, namely, the ECG lead which allows selection of Long ECG review storage.

ST Use: ST Point, J+60 and J+80, and ST use mode can also be set.

Smart Lead Off: in case that Smart Lead Off is selected, when the lead that is set in ECG or being displayed on the interface is disconnected but there are other leads still useable, the system will automatically select the useable leads and re-compute the heart rate. Still, when it is reconnected, the now connected lead will be automatically restored to its original state.

6.1.8 ST Analysis

- The ST analysis function is not suitable for <10 kg.
- ST analysis can measure ST elevation or reduction on a given lead.
- Unit of ST measured value: mV or mm.
- Meaning of ST measured value: a positive number indicates an elevation while a negative one indicates a reduction.
- ST Measuring Range: (-2.0 mV)~(+2.0 mV).



Warning

- ST data should not be used as a judgment standard for doctors and its clinical significance is decided by the doctors.

◆ ST Analysis On/Off

Select [Main Menu]-[ECG Setup]-[ST Analysis>>] or select ECG waveform region or parameter region to enter ST Analysis window. ST segment can be set [On] or [Off].

◆ Filter Mode

ST Analysis function proceeds only when the Filter Mode is in the Diagnose Mode. ST Analysis function will be automatically stopped when the Filter Mode is switched to "Monitor" or "Surgery" from "Diagnose", but the ST Analysis can still be started at this moment. Once it is started, the Filter Mode is automatically switched to the Diagnose Mode; ST Analysis function is still stopped but can be manually started if the Filter Mode is switched from Monitor or Surgery to Diagnose.

◆ ST Display

Figure 6.9 shows 5-Lead ST display.

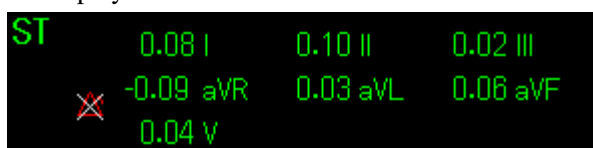

Figure 6.9 ST Data Display

Select ST parameter region, and enter ST Analysis menu.

◆ ST Value

A maximum of 12 ST numerical values can be simultaneously displayed on this series of monitors screen.

◆ ST Alarm

ST alarm is defaulted to Mid Level (Users are allowed to reset in the ST Alarm menu). Each lead has its own alarm limit. ST alarm will be triggered when an ST numerical value exceed ST alarm delay time (ST alarm delay time is user definable, as referred to section 7.5.4 **ST Alarm Delay Setup**). When any ST alarm switch is switched on or off, the ST alarm of other leads will be switched on or off; and it is the same for the option of Alarm Level Setting.

◆ ST Alarm Limit Setup

Select [Alarm Setup>>] in the window [ST Analysis], and then set the alarm limits, levels and records.

◆ ST Waveform Review

Select [ST Waves Setup>>] in the window [ST Analysis], and then set the lead for reviewing ST segment characteristic waveform. When several ST waveform leads are selected, waveforms will be stack-displayed.

◆ Determining ST Analysis Point

ST measured value is the vertical drop between the pre-set ISO and ST points and the crossing point of ECG waveforms, as in Figure 6.10:

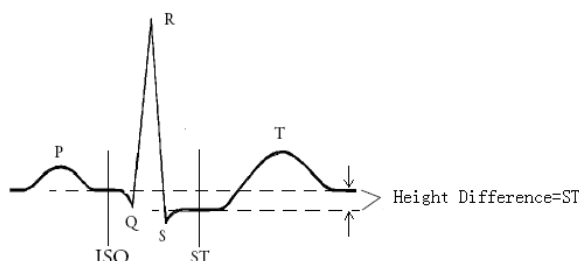

Figure 6.10 ISO and ST Analysis Point

ISO and ST points are required to be adjusted when animal's HR or ECG waveforms are undergoing obvious changes. ISO and ST points can be adjusted in the window ST Analysis menu.

Warning

- Please make sure that an ST measured point is set correctly for monitored animals.

6.1.9 Arrhythmia Monitoring

Arrhythmia analysis provides information concerning the condition of animals, such as heart rate, PVC frequency, rhythm and ectopic beats.

Warning

- The arrhythmia analysis function is not suitable for <10 kg.
- The arrhythmia analysis function is applicable to detection of ventricular arrhythmia, but not for atrial or supraventricular arrhythmia. However, this may lead to detection of incorrect arrhythmia information; thus doctors are required to analyze arrhythmia information by combining more clinical manifestations.
- The designated equipment performance index may be unattainable due to the occurrence of some common arrhythmia.

Attention

- It is important to select appropriate leads for arrhythmia monitoring, and lead selection can be done in [ECG Setup]-[ECG1].

◆ Viewing Arrhythmia Waveform

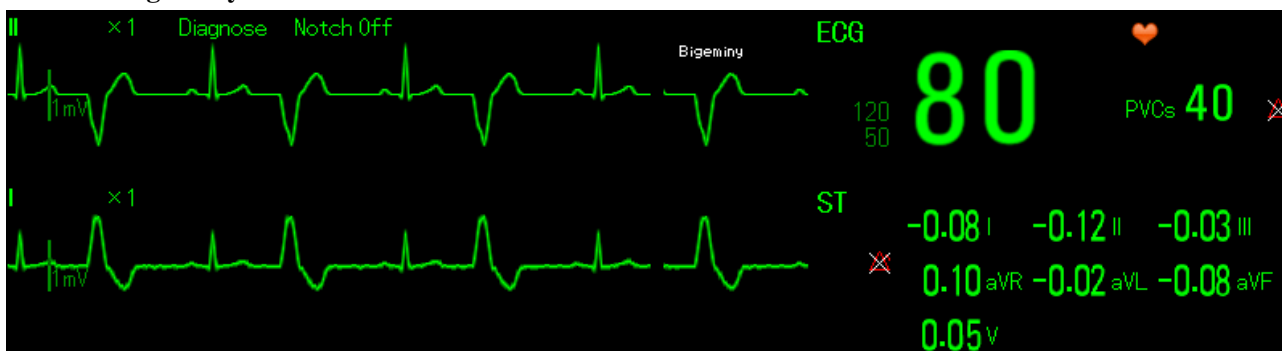

Figure 6.11 Arrhythmia Waveform Example

◆ Arrhythmia Rhythm State Information

This series of monitors display arrhythmia rhythm state information including: Asystole, VT (ventricular tachycardia), Non-Sustained VT, Tachy (tachycardia), Brady (bradycardia), Vent Rhythm (ventricular rhythm), Bigeminy, Trigeminy, Irregular Rhythm, SNR (sinus rhythm), Paced Rhythm and Unknown Rhythm.

The rhythm state information is displayed at the right side of the principal ECG waveform. It is updated once every 5 seconds.

6.1.10 Arrhythmia Alarm

◆ Arrhythmia Alarm and Classification

Table 6.2 Arrhythmia Alarm and Classification

Alarm Information	Trigger Condition	Classification
Asystole	Heart beat not detected when preset cardiac arrest threshold time has passed.	Fatal arrhythmia (High-Level Alarm)
VFib/VTac (ventricular fibrillation/ventricular tachycardia)	Fibrillating waves last consistently for 6s/Dominant rhythm of the adjacent ventricular heart beats (V) and the heart rate is greater than the upper limit of ventricular tachycardia.	
VTac	Consecutive PVCs are greater than the Sustained VT limit	

	and Ventricular HR is greater than V-Tach HR Limit.	
VB (Ventricular Bradycardia)	Consecutive PVCs are greater than or equal to the vent rhythm limit and Ventricular HR is lower than the V-Brad HR Limit.	
Extreme-Tachy	Heart rate exceeds extreme tachycardia threshold.	
Extreme-Brady	Heart rate lower than extreme bradycardia threshold.	
Non-Sustained VT	Consecutive PVCs are lower than the Sustained VT limit but more than two, and Ventricular HR is greater than the V-Tach HR Limit.	
PVC	Single PVC is detected in normal heartbeat.	
Tachycardia	The average heart rate is greater than the limit of the tachycardia.	
Bradycardia	The average heart rate is lower than the limit of bradycardia.	
VR (ventricular rhythm)	Adjoining dominant rhythm of ventricular heart beats exceeds idioventricular rhythm threshold numbers and heart rate is lower than ventricular tachycardia (VT).	
V-Bigeminy	Rhythm N, V, N and V.	
V-Trigeminy	Rhythm N, N, V, N, N, V.	
Irr.Rhythm	Continuous irregular rhythm.	
PVCs/min	PVCs/min exceeds preset higher limit.	Non-fatal arrhythmia (Mid-/Low-Level Alarm)
Run PVCs > 2	More than 2 continuous PVCs in the last minute.	
Couplet	Paired PVCs detected in the last minute.	
R on T	R-wave on T-wave detected in the last minute.	
Multiform	Ventricular premature of 2 or more forms is detected in the last minute.	
HeartBeat Pause	Heart beat not detected when preset asystole threshold time has passed.	
Missed Beats	In case the heart rate is below 100, heart beat is not detected within a period that is 1.75 times the average RR intervals or in case the heart rate is above 100, heart beat is not detected in 1 second.	
PNC (Pacemaker Not Capture)	Asystole with pace-making pulse in the last minute (Only applicable to pacemaker-wearing animals).	
PNP (Pacemaker Not Pace)	No pace-making pulse detected within a period that is 1.75 times the average R-R intervals (Only applicable to pacemaker-wearing animals).	

◆ Arrhythmia Alarm Setup

Select [Alarm Setup] - [Arrh.Analysis], or select ECG parameter region or Waveform Region - [Arrh.Analysis>>], and then set alarm setting for each sort of arrhythmia in the pop-up menu. Select alarm switch for each option to start or stop corresponding arrhythmia analysis function; you can also switch on/off the arrhythmia analysis alarm by selecting three functional buttons below the menu: [Lethal Only], [All Off], and [All On].

**Attention**

- Fatal arrhythmia defined in this series of monitors include: Asystole, and VFib/VTac (ventricular fibrillation/ ventricular tachycardia).
- Please set the fatal arrhythmia alarm switch in [User Maintain>>]-[Alarm Config>>]-[Fatal Arrh.Off]; when [Fatal Arrh.Off] is enabled, the fatal arrhythmia function is stopped, and when disabled, it can't be stopped.
- When [Fatal Arrh.Off] is disabled, the button [All Off] is invalid and any user operations are disabled, also.
- The system defaults the fatal arrhythmia alarm level at High-Level, and user is not allowed to reset.

**Warning**

- When all arrhythmia analysis alarm functions are disabled, the system is unable to provide any arrhythmia alarm information, which requires user to pay close attention to animal's clinical condition.

◆ **Arrhythmia Alarm Mode Setup**

Since arrhythmia alarm is instantaneous during arrhythmia analysis, it is suggested that user select Latch Alarm for arrhythmia detections to prevent any possible failure to responding to arrhythmia information which could happen when Unlatch Alarm mode is selected. You can set Latch Alarming in [User Maintain>>] - [Alarm Config>>] - [Alarm Mode].

◆ **Arrhythmia Threshold Setup**

Select [Alarm Setup] - [Arrh.Threshold], then user can set threshold for arrhythmia, and alarm is to be triggered in case that an arrhythmia exceeds the preset threshold.

Table 6.3 Arrhythmia Threshold Setup

Parameters	Setting Range	Default Value
QRS Pause (s)	1.5, 1.75, 2, 2.25, 2.5	2
Cardiac Arrest (s)	2.5s, 3s, 3.5s, 4s	4
VT (ventricular tachycardia) (bpm)	20, 25, 30, 35, 40.....295, 300	100
VB (Ventricular Bradycardia) HR	15~60	40
Sustained VT (s)	3, 4, 5..... 99	15
VR (ventricular rhythm)	3, 4, 5..... 99	5
PVCs/min	1, 2..... 99	10
Extreme VT-H (bpm)	17~300	140
Extreme VB-L (bpm)	15~298	30

◆ Arrhythmia Alarm Link

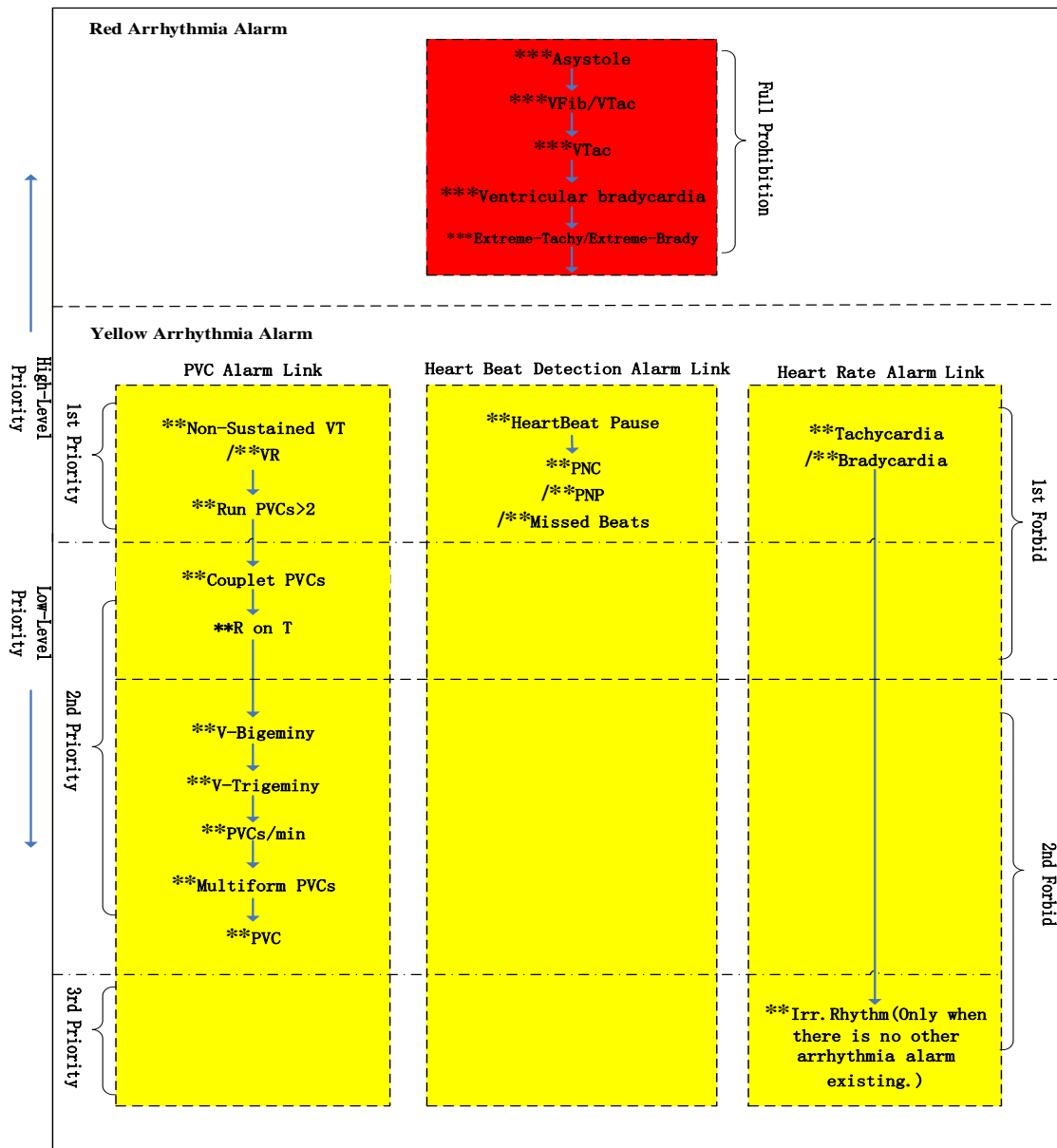

Figure 6.12 Arrhythmia Alarm Link

When arrhythmia analysis function is enabled, it is possible that several alarm states are coexistent. Reporting all detected alarms will bring about confusion and may even hide more serious conditions. Therefore, except for high-level arrhythmia alarm, this series of monitors will select three alarm links for mid-/low-level arrhythmia alarm to arrange alarm priority: PVC alarm link, heart beat detection alarm link and heart rate alarm link, as shown in Figure 6.12.

Descriptions on alarm priorities in alarm link:

- In a single alarm link, alarm priority from top to bottom is sequentially lowered, and a lower-priority alarm will be replaced by a high-priority one; when several alarm conditions are triggered on the same link, the system only displays the alarm information of the highest priority.
- High-level arrhythmia alarm has the highest priority, and when it is triggered, alarm conditions on the other three alarm links will be forcibly ignored.
- In a tri-alarm link, the alarm of the same priority has no effect on its counterparts.
- In a tri-alarm link, when alarms of different priorities on different links are triggered, the alarm of higher priority will replace those of lower priorities on other links.

For example, when ‘R on T’ alarms, the ‘V-Trigeminy’ on the same link will not alarm even if it takes place; if ‘Extreme-Tachy’ alarm is triggered, ‘R on T’ will be replaced due to its lower priority even if they belong to two different links. If ‘VR’ is triggered later, the two alarms will be given simultaneously without affecting the other because they have the same priority on different links. Once ‘VFib/VTac’ or other high-level arrhythmia alarm is triggered, all alarms on the other three links will be alternated.

◆ Arrhythmia Forbidden Time

Arrhythmia alarm is instantaneous, thus it is possible that users will neglect some alarm information. In order to avoid this, we designed the system to handle mid-/low-level arrhythmia alarm differently from other physiological alarms: once arrhythmia alarm is triggered, both the same type of alarm condition will not be repeatedly triggered and the alarms of lower priorities is disabled at the present time. We refer to this period as to the Arrhythmia Forbidden Time.

As illustrated in Figure 6.12, this series of monitors categorize the mid-/low-arrhythmia into the First Forbidden Time and the Second Forbidden Time.



Attention

- Prohibition period of High level arrhythmia alarm default must be manually eliminated in the alarm line, but you can press [SILENCE] to end the prohibition period of high level arrhythmia alarm. The full prohibition in [Alarm Config>>] is defaulted on, When it is set as off, prohibition period ends automatically if it detects ECG signal.
- Users can set the forbid time in [User Maintain>>]-[Alarm Config>>]-[1st Forbid Time] / [2nd Forbid Time].

During the forbidden time of a mid-/low-level alarm when a higher-priority alarm is triggered, the forbidden time of this alarm is instantly over and the system enters the forbidden time for higher priorities.

During the forbidden time of a mid-/low-level alarm when a higher-priority alarm not belonging to any alarm link is triggered:

- The monitor will maintain its current alarm condition if no updating operation is conducted.
- The forbidden time is instantly over when the [PAUSE] is pressed or the alarm switch is stopped. In case this alarm is still valid when the alarm pausing is activated, the forbidden time will be recalculated from its first triggered moment following the end of the alarm pausing.
- The forbidden time is not affected when the [SILENCE] is pressed.
 - In case this alarm is terminated when the [SILENCE] is pressed, the alarm information will be instantly cleared when the [SILENCE] is pressed. During the forbidden time, the same alarm or an alarm of lower priority is not triggered for a second time.
 - In case this alarm is not terminated when the [SILENCE] is pressed, the alarm will be muted when the [SILENCE] is pressed: audio alarm disappears and a narrative alarm is added with a ‘√’ in the front, and if this alarm terminates during this forbidden time, narrative alarm disappears instantly when the alarm terminates. The same alarm or the alarm of lower priorities can only be triggered again when the forbidden time has elapsed.

6.1.11 ECG Relearn

◇ Manually Starting ECG Relearn

During ECG monitoring, you may need to start ECG relearn when the patient’s ECG templates undergo significant changes. Changes of ECG templates may lead to:

- Wrong arrhythmia alarm
- ST measurement loss

- Incorrect heart rate

ECG relearn function enables the monitor to learn new ECG templates for correcting arrhythmia alarm and recovering ST measurement. To manually start ECG relearn: select [Main Menu]-[Parameters]-[ECG Setup]-[Relearn], or select ECG Waveform Region or Parameter Region, then [ECG Setup]-[Relearn].



Attention

- Please start the relearn function during normal rhythm or when ECG signals are relatively absent of noise. Because if you start ECG relearn during arrhythmia, the wrong QRS waves may be learned as ECG templates leading to missed detection of arrhythmia events.

◇ Auto-Starting ECG Relearn

In the following cases, ECG relearn will be automatically started:

- Change of animal category.
- Change of pacemaking status.
- Change of [ECG 1] or [ECG 2] in the [ECG Setup] interface.
- To reconnect the cables.

6.2 Resp

6.2.1 Resp General Description

This series of monitors' measure respiration through the method of thoracic electrical bio impedance. The size and shape of a breathing animal's thoracic cavity varies, resulting in changes in impedance between the two electrodes placed on the animal's chest. Thus the breathing rate can be calculated according to the impedance variation cycles.



Warning

- Anti-electrotome ECG cables are prohibited for use while monitoring an animal's respiration.
- All leads on 5-lead ECG cables should be connected with an animal's body for the sake of safety.
- Respiration measure is unable to find the causes of apnea, thus it cannot be used for diagnostic purpose.



Attention

- Resp monitoring is not applicable to animals having a large-range of activities, lest any wrong alarm is possibly triggered.

6.2.2 Resp Display

Resp data display interface is shown as Figure 6.17:



Figure 6.17 Resp Data Display

6.2.3 Placing Respiration Electrodes

Before placing, you need to treat an animal's skin where the electrodes are to be placed, as referred to in skin treating method in the ECG section. The electrodes are connected by referring to above methods mentioned in ECG connection.



Attention

- It is required to readjust the position of the two respiration-measuring electrodes in the process of measuring respiration, but this may affect ST and arrhythmia analysis.
- The hepatic region and ventricle are on the line of the resp electrodes so as to reduce the effect of cardio motility upon respiration waveforms; this is highly important with < 10 kg.
- For abdominally breathing animals, the electrode on the animal's left leg should be placed where the left abdomen has the largest expansion to obtain optimal respiration waveforms.
- In case a negative thoracic pressure is generated for some animals (<10 kg in particular) when their thoraxes are expanding laterally, it is better to place the two respiration electrodes in the region between the right midaxillary line and left thorax where respiratory movement is more evident than other regions, so as to obtain optimal respiratory waves.

6.2.4 Resp Setup

Select [Main Menu]-[Parameters]-[Resp Setup] or enter [Resp Setup] from Resp waveform region or parameter region.

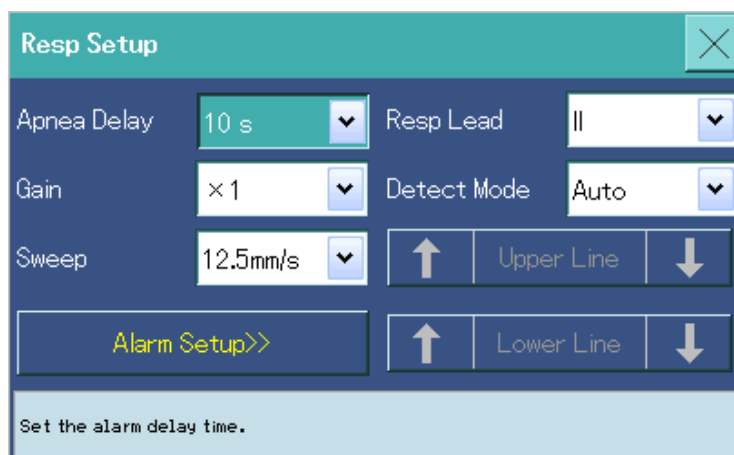

Figure 6.18 Resp Setup

◆ Apnea Delay Setup

Select [Apnea Delay]: 10s, 15s, 20s, 25s, 30s, 35s and 40s. Its default is 10s. When apnea delay is set, the monitor will alarm in case the apnea period exceeds the preset values.

◆ Gain Setup

Select [Gain]: $\times 1/4$, $\times 1/2$, $\times 1$, $\times 2$, $\times 4$ and Auto. It allows setup of waveform gain positions to meet different clinical requirements.

◆ Sweep Setup

Select [Sweep]: 6.25 mm/s, 12.5 mm/s, and 25.0 mm/s. It allows selecting desired waveform speeds. A larger speed means faster scanning and wider waveforms.

◆ **Resp Lead Setup**

Select [Resp Lead]: I and II. It allows selecting the desired lead to meet different clinical demands for optimal respiratory waves.



Attention

- In order to obtain optimal respiratory waves, RA and LA electrodes should be kept level when I-lead is selected for resp measure, and RA and LL electrodes should be diagonally kept when II-lead is selected.

◆ **Detect. Mode Setup**

Select [Detect. Mode]: Auto and Manual. Respiratory wave calculation mode can be set.



■ Auto Mode

In this mode, the monitor will automatically adjust the detection level according to waveform height and whether cardiac artifact is existent, but the detection level dotted line is not displayed on the respiratory waveforms.

[Auto] mode is recommended when respiratory rate is not close to the heart rate or animals are actively respiration.

■ Manual Mode

In the Manual mode, users are required to set the respiratory detection level. Select [Upper Line] and [Lower Line] to manually relocate the detection level dotted line on the respiratory waveforms. Once determined, the detection level will not automatically adapt to different depths of respiration. Thus, users are required to readjust the detection level to adapt to changes in the depths of respiration according to actual conditions.

Users can directly click  and  in the window to raise or lower the upper/lower dotted lines if the touch screen function is configured. When the upper/lower dotted lines of the respiratory waves are blocked by [Resp Setup] Window, users can click the title panel on the window to drag it until the upper/lower dotted lines can be relocated.



Attention

- In case the respiratory waves are not displayed on the respiratory oxygenation diagram interface or main screen, the detection level is still not adjustable even if the [Detect. Mode] is set Manual.

◆ **Respiration Alarm Parameter Setup**

Select [Alarm Setup>>] to enter the menu [PAR.Alarm], then users can set RR alarm attributes, including: Alarm Switch, Alarm Higher/Lower Limit, Alarm Level and Alarm Record On/Off.

6.3 PR

6.3.1 PR General Description

The mechanical movement of the heart causes pulsation of arteries, and the PR (pulse rate) can be obtained by measuring this pulsation. The PR numerical value can be obtained through SpO₂ or any arterial pressure (IBP).

6.3.2 PR Source

Pulse is displayed in PR parameter region.



Figure 6.19 PR Parameter Region

When effective pulse origin is displayed in the PR parameter region, the pulse rate (PR) of the pulse can be:

- Detected as the system pulse and an alarm triggered when users select PR as an alarm source.
- Stored in the monitor database and reviewed in tendency diagram and tendency chart.
- Transmitted to the central monitoring network when network is available.

PR Source Setup

Select the PR parameter region or open the [SpO₂ Setup] menu, and then select [PR Source]: Auto, SpO₂, IBP1 and IBP2. When Auto is selected, the system selects an item from the selection list as its PR Source. The system automatically switch the [PR Source] to [Auto] when the current PR source is not available.

6.3.3 Alarm Source Setup

As referred to Alarm Source Setup in section 6.1.6.

6.3.4 Pulse Volume Setup

Select the PR parameter region or open the [SpO₂ Setup] menu, and then select [Pulse Volume]: 0~10.

6.4 SpO₂

6.4.1 SpO₂ General Description

SpO₂ plethysmography parameter measures arterial pulse oxygen saturation, or the percentage of total oxyhaemoglobin. For example, if the hemoglobin molecules accounting for 97% of the total of the erythrocyte in arterial blood are combined with oxygen, the blood has a 97% SpO₂ oxygen saturation and the reading of SpO₂ values on the monitor is 97%.SpO₂ value represents a percentage of hemoglobin molecules that are formed into oxyhaemoglobin.SpO₂ plethysmography parameter can further provide pulse rate and plethysmography wave.SpO₂ plethysmography parameter measure works as follows:

- Oxygen saturation is measured by pulsation oximetry. This is a continuous, non-invasive method for measuring hemoglobin oxygenation saturation. It measures the rays emitted from the sensor optical source that are irradiated to the receiver on the other side after penetrating through animal's tissue (such as tongue or ears).
- The quantity of penetrating rays is determined by several factors, most of which are constant. But, with arterial blood, one of these factors, changes with time and thus it is pulsatory. By measuring the rays absorbed during pulsation durations, we can obtain the oxygen saturation of the arterial blood. A 'plethysmography' waveform and pulse rate information can be given by detecting the pulsation.
- It is the functional saturation measured and displayed after calibration: the amount of oxygenated hemoglobin is expressed in the percentage of the hemoglobin that can transport oxygen. Fractional saturation: oxygenated hemoglobin percentage of all measured hemoglobin (including dysfunctional hemoglobin, such as carboxyhemoglobin or methemoglobin). To convert fractional saturation to functional saturation, the following formula is required:

$$\text{functional saturation} = \frac{\text{fractional saturation}}{100 - (\% \text{Carboxy hemoglobin} + \% \text{methemoglobin})} \times 100$$

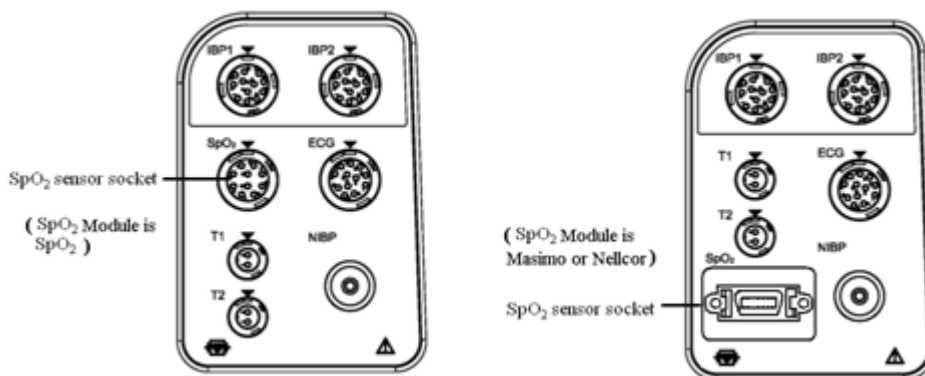

Figure 6.20 SpO₂ Sensor Socket

This series of monitors are able to display the functional degree of blood oxygen saturation by displaying on the screen the plethysmography waveform and parameter values, as shown in Figure 6.21:

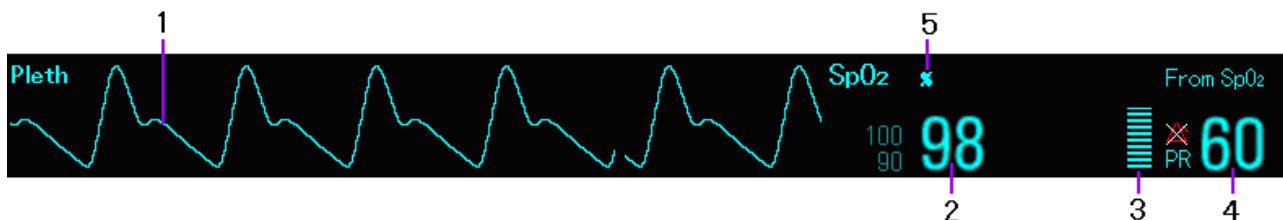

Figure 6.21 SpO₂ Waveform and Parameter Display (SpO₂ Module)

1. Pulse oximetry Wave (Pleth): an animal’s pulse signal intensity has no influence on Pleth waveform amplitudes.
2. Arterial oxygen saturation: percentage of oxyhemoglobin in total hemoglobin.
3. Dynamic plasma: in direct proportion to pulse intensity.
4. Pulse rate (PR): pulse rate measured every minute.
5. %: blood oxygen unit.

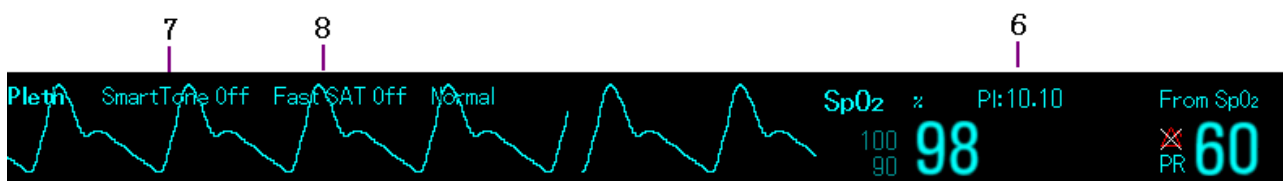

Figure 6.22 SpO₂ Waveform and Parameter Display (Masimo SpO₂ Module)

6. PI:10.10: Weak perfusion index.
7. Smart Tone: smart pulse tone
8. Fast Sat: fast blood oxygen mode.

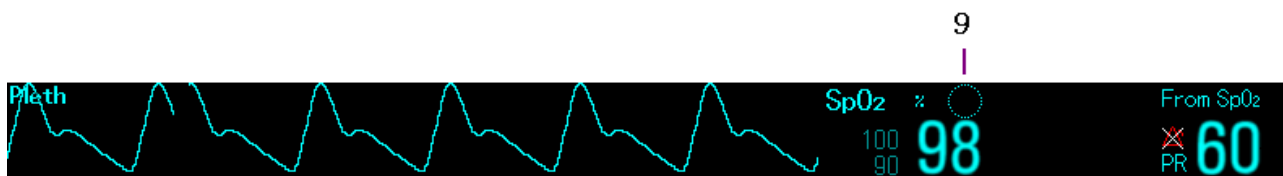



Figure 6.23 SpO₂ Waveform and Parameter Display (Nellcor SpO₂ Module)

9. : integral value of Sat Second Time.

6.4.2 Safety Information



Warning

- Only the blood oxygen sensor specified in the User manual is allowed; and it should be used by following all warnings and warnings specified in the User manual.
- If Masimo SpO₂ module or Nellcor SpO₂ module is configured, please carefully read the instructions for the corresponding sensor before use.
- In case of any damage to the packing of the sterilization-marked blood oxygen sensor, please discontinue use and contact the sensor supplier.
- An oximeter should be used for analyzing blood samples in case the animal is likely to be oxygen-deficient to get a more complete understanding of the animal's condition.
- Any use of the monitor and its sensors while an NMR equipment is in use should be avoided, lest any serious burn is caused by inductive currents.
- Adhesion positions of sensors should be checked once every 2 hours while long-time continuous monitoring for animals are being conducted and should be properly moved when skin condition changes or every 4 hours. More frequent examinations may be necessary for some animals, such as <10 kg and perfusion-difficult or skin-allergic animals. Long-time continuous monitoring will possibly add some unpredictable changes on skin, such as allergy, reddening, blistering or pressure necrosis, etc.



Attention

- Fingers should be correctly placed into the sensor (as referred to relevant drawings in the User manual). Inappropriate placement will produce inaccurate measure.
- Improper securing of blood oxygen sensor with adhesive tape will yield venous pulse, which may cause inaccurate SpO₂ measure.
- Clear any ray-barring obstacle along the light path.
- Strong light beams and electromagnetic interference in the area and excessive amount or level of animal's activity may lead to wrong readings of the monitor.
- When blood oxygen sensors are used, be cautious to shield external optical source, such as optical beams for heat therapy or from infrared lamps, otherwise interference may be introduced to the measure.
- It is possible that accurate blood oxygen measuring results are not available in case of shock, low temperature or use of vaso-active drugs as well as in the case of existence of carboxyhemoglobin, methemoglobin, methylene blue, cyanine green, indigo carmine and other substances.
- When non-invasive blood pressure and blood oxygen are simultaneously measured, please make sure that blood oxygen sensor and the non-invasive blood pressure cuff are not placed on the same limb, since non-invasive blood pressure (NIBP) measure will block blood flows, affecting the blood oxygen measure.



Explain

- The materials that contact with animals, or may come into contact with other personnel are non-toxic and had no impact on tissues, but long-term exposure should be avoided.
- For incomplete signals, if the plethysmography waveform is displayed, determine the normalization coefficient according to the maximum value and the minimum value in the period of time of the signal, and normalize the display signal to 0~127.
- The functional tester cannot be used to evaluate the accuracy of the pulse oximeter probe and pulse

oximeter monitor. However, it can be used to demonstrate a particular calibration curve reproduced by pulse oximeter, and has been proved to meet the specific accuracy specification.

- If the pulse oximeter has a specific calibration curve and it is accurate for the combination of the pulse oximeter and pulse oximeter probe, the functional tester will be able to measure the overall error of the monitor / probe system from the monitor, and will also be able to test the accuracy of the pulse oximeter that copies the calibration curve.

Clinical Restriction

1. The measure is based on small arterial pulsation, thus the subject must have the smallest pulsatory blood flows. A weaker pulsation caused by shock, coldness or hypothermia, huge blood loss and use of vaso-constricting drugs will lead to smaller pulse oximetric (Pleth) waves, and thus to more sensitive to interference in measure.
2. The monitor may give inaccurate pulse oximetric values when a substantial amount of dyeing/thinning materials (such as methylene blue, indocyanine green, and sodium indigodisulfonate), carbon monoxyhemoglobin (COHb), or methionine (Me+Hb), thiohaemoglobin exists in subjects or the measure is conducted for some icterus animals.
3. Dopamine, procaine, prilocaine, lidocaine, buzocaine and other drugs may cause severe measured deviation for pulse oximetry.
4. Pulse oximetry only has referable significance to anemic anoxia and toxic anoxia, because some severe anemian animals may still present relatively better pulse oximetry measured value.

6.4.3 SpO₂ Module

The user can select and configure the SpO₂ module as needed. The monitor can support three types of SpO₂ module: SpO₂ module, Masimo SpO₂ module, and Nellcor SpO₂ module. The monitor has been configured in the factory according to the module selected by the user.

Select sensor

Please select the sensor according to the configured oximeter module, considering factors such as the animal's weight, perfusion, application position of the sensor and the monitoring period. To get more information, please refer to the A.2 Accessories, or contact your sales representative. Please select the appropriate sensor, follow the usage instructions, and also comply with all the warnings and cautions in the User Manual of the sensor.



Attention

- The sensor interface of SpO₂ module is different from and incompatible with the Masimo SpO₂ module/Nellcor SpO₂ module.

6.4.4 Monitoring Steps

- 1 Select appropriate oximeter sensor according to the module type, animal type and weight.
- 2 Place blood oxygen sensor probes on animal's body.
- 3 Select the oximeter extension cord according to the SpO₂ interface type of the module, and connect the oximeter extension cord to SpO₂ interface of the monitor.
- 4 Connect the blood oxygen sensor with the extension cable.

Connection of Pulse Oximetry Probe

The pulse oximetry probe is a complex measuring instrument which should be used for measuring by following current methods and steps. Improper operational method may cause damages to the probe.

Steps of Operations:

1. Connect the plug of the pulse oximetry probe to the corresponding 'SpO₂' interface on the left panel of the monitor. Please push or pull plug by using fingers to hold the plug head.
2. Insert the forefinger or middle finger or ring finger of the subject into probe by referring to Figure 6.24.

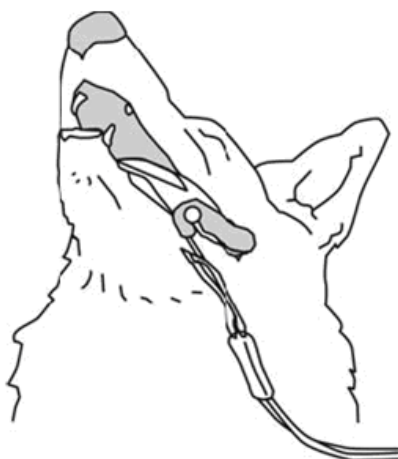

Figure 6.24 Diagram on Pulse Oximetry Probe and Finger Positions



Attention

- Don't fold or twist the cables.

6.4.5 SpO₂ Setup

Open the [SpO₂ Setup] menu by:

- Select [Main Menu]-[Parameters], and select [SpO₂ Setup].
- Select SpO₂ waveform region or parameter region to enter [SpO₂ Setup].

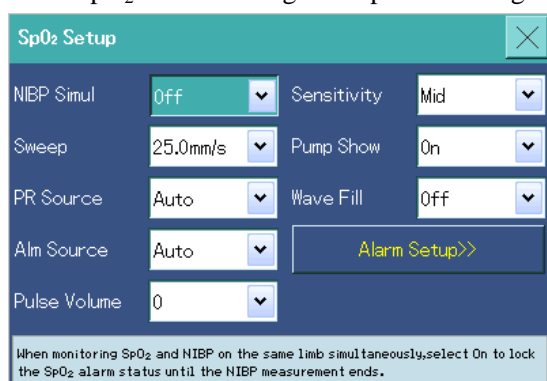

Figure 6.25 SpO₂ Setup (SpO₂ Module)

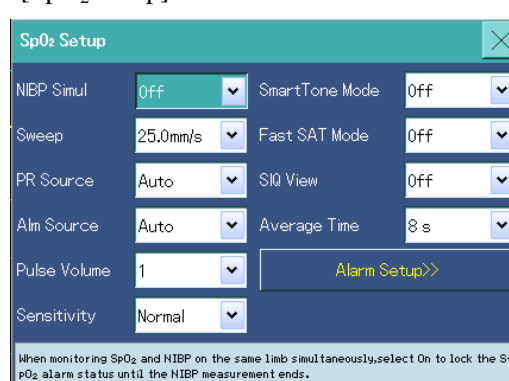
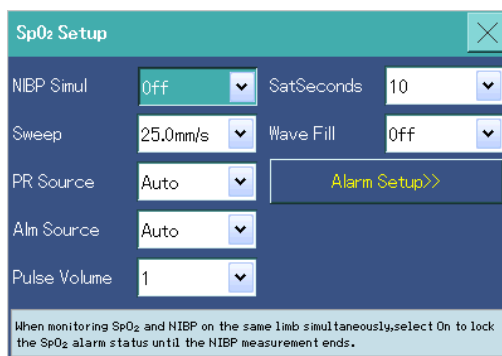

Figure 6.26 SpO₂ Setup (Masimo SpO₂ Module)

Figure 6.27 SpO₂ Setup (Nellcor SpO₂ Module)

◆ **NIBP Simul Setup**

Select [NIBP Simul]: On/Off.

It should be set [On] when NIBP and SpO₂ measures are conducted on the same limb of the animal until the NIBP measure is completed so as to maintain SpO₂ physiological alarm state constant while doing NIBP measure. If it is set [Off], the weak perfusion caused by NIBP measure may lead to reduced SpO₂ measuring accuracy and trigger SpO₂ alarm while the NIBP measure is in process.

◆ **Sweep Setup**

Select [Sweep]: 12.5 mm/s and 25.0 mm/s. Set pleth waveform scanning speed, and a larger value will result in higher scanning speed and wider waveforms.

◆ **PR Source Setup**

Select [PR Source]: SpO₂, IBP1, IBP2 and Auto. The system automatically switches the [PR Source] to [Auto] when the current PR source is not available.

◆ **Alarm Source Setup**

As referred to Alarm Source Setup in section 6.1.6.

◆ **Pulse Volume Setup**

Select [Pulse Volume]: 0~10.

◆ **Sensitivity Setup**

The SpO₂ values displayed on the monitor are results achieved by averaging data sampled within a given period of time. A shorter averaged time represents a higher response speed of the monitor yet lower measuring accuracy when the animal's SpO₂ values are changing. Correspondingly, a longer averaged time represents lower response time of the monitor yet higher measuring accuracy when the animal's SpO₂ values are changing. A relatively shorter averaged time is conducive to analysis of conditions of critical animals that are being monitored.

SpO₂ module: select [Sensitivity]: High, Mid and Low, and corresponding averaged time: 7s, 9s and 11s.

Masimo SpO₂ module: select [Sensitivity]: highest, normal, and APOD (Adaptive Probe Off Detection), indicating that the sensitivity can automatically adapt with the probe off detection. The average time that can be set is 2-4s, 4-6s, 8s, 10 s, 12s, 14s or 16s.

◆ **SIQ display**

Apply to Masimo SpO₂ module, display SIQ waveform signal or not. SIQ waveform directly reflects the credibility of the saturation value, and indicates the position of the pulse at the same time.

◆ **SmartTone mode**

Apply to Masimo SpO₂ module, smart pulse tone; enable this mode to accurately capture the pulse signal when the pulse signal is interfered with.

◆ **FatSat mode**

Apply to Masimo SpO₂ module, fast oximeter mode.

◆ Satseconds

Apply to Nellcor SpO₂ module; to prevent the SpO₂ values exceeding the alarm limit instantly or within a short time and causing false alarms; when the Satseconds function is enabled, the greater the value, the longer the fault-tolerant time is.

◆ Pump Show Setup

Select [Pump Show]: On or Off.

[On]: pump Show is displayed in SpO₂ parameter region.

[Off]: pump Show is not displayed in SpO₂ Parameter region.

◆ Wave Fill Setup

Select [Wave Fill]: On or Off.

[On]: Pleth waveforms on screen are displayed being filled.

[Off]: Pleth waveforms on screen are displayed not being filled.

◆ Alarm Setup

Select [Alarm Setup>>>], and SpO₂-matched [PAR.Alarm] will automatically pop up, which enable Setup of on/off of alarm, higher and lower alarm limits, alarm levels, and whether or not to open the alarm record.

6.4.6 Influencing Factors of Measure

- Animal's body movement
- Electromagnetic influence, e.g. by NMR equipment
- Electro surgical equipment
- Existence of some dyes
- Outside optical radiation
- Improper placement of blood oxygen sensor or use of incorrect blood oxygen sensor
- Animal's shock, anemia and low temperature

6.4.7 Masimo Information



- Masimo patent
The monitor is protected by the following U.S. patents: 5, 758, 644; 6, 011, 986; 6, 699, 194; 7, 215, 986; 7, 254, 433; 7, 530, 955. International patents are universal.
- No implied license
- Possession or purchase of this device neither means that you can replace one or some parts of the device, nor means that you can use the patents of the device.

6.4.8 Nellcor Information



- Nellcor patent
- Pulse oximeter is protected by one or several of the following U.S. patents and corresponding foreign patents: Patent No. 5, 485, 847; 5, 676, 141; 5, 743, 263; 6, 035, 223; 6, 226, 539; 6, 411, 833; 6, 463, 310; 6, 591, 123; 6, 708, 049; 7, 016, 715; 7, 039, 538; 7, 120, 479; 7, 120, 480; 7, 142, 142; 7, 162, 288;

7, 190, 985; 7, 194, 293; 7, 209, 774; 7, 212, 847; 7, 400, 919.

- No implied license
- Possession or purchase of this device neither means that you can replace one or some parts of the device, nor means that you can use the patents of the device.

6.5 NIBP

6.5.1 NIBP General Description

Blood pressure measure includes invasive (by directly inserting sensors into blood vessel) and non-invasive methods. The invasive method directly measures blood pressure through arterial retention needles; but this method may put animals at some risk, so it is used only if it is necessary for the animal's homodynamic. There are several non-invasive measuring methods, among which the Coriolis sound method and the oscillation method are more prominent. The Coriolis sound method is traditionally the measuring method by means of stethoscopes. The oscillation method works as follows: an inflator is used for automatic inflation, then slow deflation follows, and a computer is employed to record the changes in the cuff pressure while deflating and then to compute the blood pressure values: first, the computer determines whether the measuring signals are good enough to ensure correct calculation; if yes, then the pressure values are computed and if not (e.g. caused by sudden movement of limbs or cuff touches), then the calculation is stopped.

The pressure changes are recorded by electronic sensors having sensitivity which is far higher than that of ears, thus measure by the oscillation method has different measuring definitions on the diastolic pressure, mean pressure and systolic pressure from that of the Coriolis sound method. The circuit of an oscillation measurer separates the cuff pressure and amplitude indicating changes of the cuff pressure with pulses and defines the blood pressure corresponding to the maximum cuff pressure amplitude as the mean pressure. In this method, the blood pressure corresponding to a 50% reduction of cuff pressure amplitude is defined as systolic pressure, and the pressure corresponding to an 80% reduction of cuff pressure amplitude as the diastolic pressure, both points indicating a maximum change of pulse differential pressures. This is equivalent to the presence of pulse sound and absence of pulse sound.

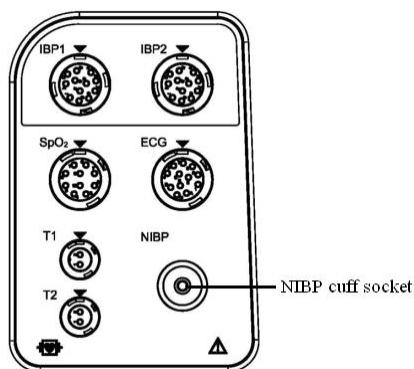

Figure 6.28 NIBP Cuff Socket

Comparison of Several Blood Pressure Measuring Methods:

In order to overcome the influence of deflating speed and doctor's sense of hearing on measuring accuracy in the traditional Coriolis sound method, researchers have made huge efforts in automatic measure of blood pressure, and the automatic blood pressure measuring system based on the principle of oscillation method was already quite well-developed. However, many medical workers are always filled with all kinds of questions, for example: what makes a lower or higher measure result in the oscillation method compared with the Coriolis sound method? Why are the first measure results higher and the following measure results gradually lower? Why are the measure results sometimes not obtainable causing useless inflations? Why are the measure results more discrete and even sometimes unreasonable? We hope that these questions will be answered through this section.

Comparison of Oscillation Method and Coriolis Sound Method

Despite sound correlation of the blood pressure measure between the oscillation method and Coriolis sound method and the invasive blood pressure measuring method, it is one-sided to compare any non-invasive and invasive blood pressure measuring methods; compared with the oscillation method, the Coriolis sound method has small error, sound reliability and high stability, and their difference is as follows:

1. The Coriolis sound method is easily susceptible to animal factors. For example: different animals show different sound recognizing abilities, different reaction capability to cardiac sound hearing and mercury gauge reading and different deflating speeds during measuring and even may have certain subjective judgments on the measure. The oscillation method is completed by computers, excluding the influence of animal factors.
2. The Coriolis sound method is based on appearing and subsiding of cardiac sounds, thus the measuring accuracy is directly affected by deflation speed and heart rate; a fast deflation process will give bad accuracy, while the oscillation method is based on oscillatory wave envelope of the cuff pressure, the deflation speed and heart rate has a relatively small influence on the measuring accuracy.
3. It is statistically shown that the measured values from the oscillation method may be smaller than that from the Coriolis sound method where the high blood pressure measure is concerned, while the values from the oscillation method for low blood pressures may be larger than that of the Coriolis sound method. But this is not indicating that one is superior or inferior to the other; it should be judged by comparing them with other methods that are accurate to determine whether the measured results are accurate or not, e.g. with the output values from invasive or non-invasive simulators. In addition, the results on the high or low side should be statistically judged. It is suggested that the medical workers who are more familiar with the Coriolis sound method measure make different physiological indexes for the oscillation method results.
4. Researches show that the Coriolis sound method yields the most inaccurate results in measuring low blood pressures. While the oscillation method are unlikely to give accurate results in measuring controlled hypertension.
5. The mean pressure in the oscillation method is directly obtained and thus it is relatively more scientific and the mean pressure in the Coriolis sound method is obtained by adding the diastolic pressure and 1/3 pulse pressure, thus it is purely an empirical result.
6. The accuracy of the oscillation method can be obtained by comparing with blood pressure measure simulators, and the manufacturers generally will check and calibrate their products through blood pressure simulators. But there are still no mature technologies to judge the accuracy of the Coriolis sound method measure.
7. Besides, the accuracy of mercury column of mercurial sphygmomanometers directly influences the accuracy of the Coriolis sound method measure and it is demonstrated that 13.2% domestic mercurial sphygmomanometers have relatively large errors in their mercury readings.
8. The measure by the oscillation method is also susceptible to movement artifact (such as occasional muscular contractions), thus relatively large deviations are obtained sometimes; but this inaccurate data can be rejected by combining with former and next measured results.

6.5.2 Safety Information

Operating Precautions

Alike the general non-invasive blood pressure measure, it is possible that inaccurate results are obtained, or even no results or inappropriate understanding of the results are produced when the oscillation method blood pressure measure is used:

1. Cuff Requirements:
 - 1) Select cuffs of desired sizes according to different animal categories: the maximum cuff pressure

shouldn't be more than 40 kPa (300 mmHg) for cuffs for >20 kg and 20 kPa (150 mmHg) for < 10 kg.

- 2) Before measuring, the residual air should be evacuated from the cuff.
- 3) The part where symbol ϕ is printed on the cuff should be placed where the arterial pulse is most evident on the brachial artery for the best result.
- 4) It is best that the tightness of the cuff should be made so that a finger can be stuck in between cuff and arm.
- 5) The lower part of cuff should be 2cm higher than the elbow joint.
2. The subject should be in a horizontal position and the cuff should be placed level with the heart for the most accurate results, other postures may cause inaccurate measures.
3. Neither movement nor cuff touch is allowed before and during measure and the gas valve connecting the cuff and the monitor should be guaranteed smooth and without being twisted.
4. Too small measuring intervals are not suitable (optimally longer than 2min), for the excessively short intervals between continuous measures can cause extrusion of arms, resulting in decreased blood flows and then decreased blood pressure.
5. It should be judged by considering clinical evaluations to determine whether or not automatic blood pressure measure is adapted for animals with severe blood coagulation mechanism disorders, for the friction between limbs and the cuff may cause risks for haematoma.
- 6 The cuff inflation pressure is automatically regulated by computer based on the last measured values in the successive blood pressure measure. It is possible that the sphygmomanometer is unable to give any result after the first inflation when the blood pressure is elevated or the animal is changed; this monitor will automatically regulate inflations and continue measuring until there are results produced, but the measure should be conducted no more than 4 times.
- 7 It should be guaranteed that correct animal categories are selected while measuring 10~20 kg and < 10 kg. Improper selections will possibly put animals into dangerous conditions, for relatively high-pressure > 20 kg setting is not suitable for 10~20 kg animal and <10 kg animal.
- 8 It is possible that no measure results will be produced when selections for 10~20 kg or < 10 kg are employed for > 20 kg measure, even though no harm will be inflicted.
- 9 The limbs used by the cuff will be possibly accompanied with purpura, ischemia and neurologic damage due to drawn-out non-invasive blood pressure measure when the Auto mode is used. Please check the color, warmth and sensitivity of animal's distal limbs regularly while monitoring. Once any abnormality is found, please relocate the cuff or terminate the blood pressure measure.



Warning

- NIBP measures are not allowed for animals with sickle cell disorders and present or possibility of incurring skin damage.
- It should be judged by considering clinical conditions to determine whether or not automatic blood pressure measure is adapted to animals with severe thrombi disorders, for the limbs used for the cuff have a possibly risk of haematoma.
- Cuff are not allowed on limbs with venous transfusion or cannula, for the transfusion is lowered or blocked due to the inflated cuff, which will possibly lead to tissue damage around the cannula.
- Please use other procedures to check animal's vital signs and then check whether or not the monitor is working well when the accuracy of the measured results is open to suspicion.

6.5.3 Measure Restriction

Measure may be inaccurate or cannot be conducted in the following conditions:

1. Blood vessels have severe convulsion, vasoconstriction and excessively weak pulse.
2. The measure is unreliable or inefficient when animals have extremely low or high heart rate or irregular arrhythmia, particularly atrial fibrillation.
3. Measure is not allowed when the animal is connected to a heart-lung machine.
4. Diuretic or vasodilator is being used.
5. The reading is unreliable when the animal is suffering massive hemorrhage, hypovolemia, shock and other conditions that cause excessively fast blood pressure changes, for reduced blood flow in peripheral blood vessels will result in lowered arterial pulsations.
6. Animals are excessively obese.
7. Limbs are edematous.

Besides, a blood pressure difference of ≥ 0.80 kPa (6 mmHg) is statistically shown to exist between the right and left arms of 37% animals.



Attention

- Some medical workers using the oscillation method to measure blood pressure have reported large discrepancies and even abnormal measured data. Actually, large discrepancies may be based on massive data statistics. It is possible that abnormal measuring data is occasionally seen in any empirical science; sometimes the reason is easily found while sometimes it may not be; there are already special methods for recognizing and excluding occasional doubtful experimental data, which will not be discussed here and doctors can exclude obviously unreasonable data by judging with their experience. Many foreign documents have indicated that it is normal for occasional error of ± 1.33 kPa (± 10 mmHg) in blood pressure measure.

6.5.4 Measure Mode

There are three measure modes:

- Manual: when necessary, NIBP measure is performed once manually.
- Auto: the monitor repeatedly and automatically conducts NIBP measure at preset time intervals.
- STAT: measure is continuously conducted every 5 minutes.

6.5.5 Measure Procedure

1. Start the monitor, if it is turned off.
2. Confirm animal category is correct.
3. Connect the air valve with blood pressure cuff interface.
4. Select cuff and confirm it is completely deflated, and tie it onto animal's upper arm or thigh.
 - a. Determine the perimeter of animal's limb.
 - b. Select appropriate cuff (applicable limb perimeters labeled). The cuff width should be 40% of the limb perimeter (50% for < 10 kg) or $2/3$ of the upper arm. The length of the inflated cuff should be sufficient to encircle 50-80% of the animal's limb.
 - c. Place the cuff on animal's upper arm or thigh and make sure the symbol is placed on the artery. Make sure that the limb is not too tight, otherwise color changes and even ischemia of the limb may follow. The cuff edge should be inside the displayed range, otherwise, please using other cuff.
5. Set measure mode in the [NIBP Setup] window.
6. Press Button [NIBP] or [NIBP Setup]-[Start NIBP] to start blood pressure measure.



Attention

- Cuff width should be appropriate for blood pressure measure, too narrow a cuff will give relatively higher blood pressure values, and too wide gives too low values.
- The cuff should be completely deflated before use to prevent any inaccurate measure caused by residual air.
- When placing the cuff, first flatten and wrap on the upper arm surface to desired tightness, as referred to Figure 6.29.

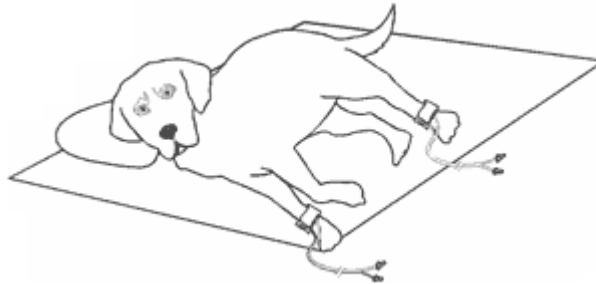

Figure 6.29 Diagram of Cuff Wearing Position

The cuff is connected to the monitor by connecting the cuff plug with the interface labeled ‘NIBP’ on the monitor. Please plug it in or out by using fingers to hold the plug head.



Explanation

- Blood pressure measurements determined with this device are equivalent to those obtained by an auscultatory method and intra-arterial blood pressure measurement device, within the limits prescribed by the IEC 60601-2-30. Selected using the invasive method validation equipment artery radial artery or the posterior tibial artery.

6.5.6 NIBP Display

NIBP measure provides no waveform display, and the NIBP measured results are displayed in the parameter region, as referred to Figure 6.30:

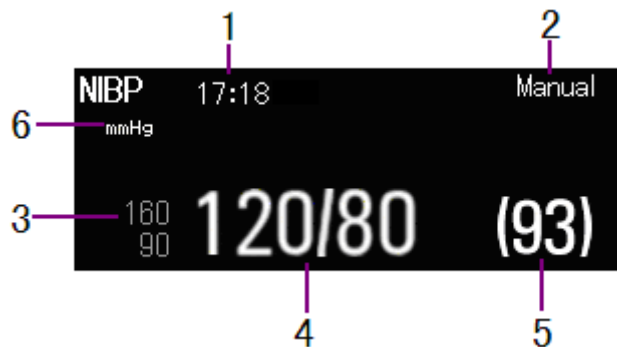

Figure 6.30 NIBP Data Display

- 1) Measure time
- 2) Measure mode
- 3) Higher and lower alarm limits
- 4) Systolic pressure/Diastolic pressure

- 5) Mean pressure
- 6) NIBP unit

6.5.7 NIBP Setup

Select [Main Menu]-[Parameters]-[NIBP Setup] or select NIBP parameter region to open the window [NIBP Setup].

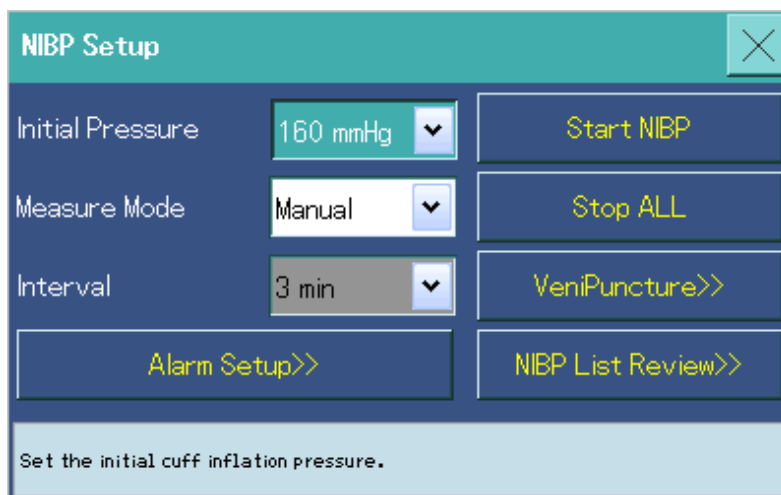

Figure 6.31 NIBP Setup

◆ Initial Pressure Setup

Select cuff initial pressure values tailored for subjects.

◆ Measure Mode Setup

1. Manual Measure

Select [Measure Mode] and then set: Manually. Press the [NIBP] button on the front panel or press [Start NIBP] to start a manual measure.

While conducting manual measure, either press the [NIBP] button on the front panel or [Stop NIBP] and [Stop All.] to terminate NIBP measure.

2. Automatic Measure

Select [Measure Mode] and then set: Auto. Press the button [NIBP] on the front panel or [Start NIBP] to manually start the first measure, and the system will automatically and repeatedly perform NIBP measure according to the time intervals defined in [Interval] when the first measure is done.

If the button [NIBP] is pressed during the idle time between automatic measures, a manual measure will be conducted. The monitor will continue automatic measures when the manual one is completed.

Press either the button [NIBP] on the front panel or [Stop NIBP] at any time the automatic measure is in process, and the current NIBP measure will end, but the system will continue its automatic measure.

Press the button [Stop All.] in the window [NIBP Setup] at any time the automatic measure is in process, all measuring tasks will be instantly ended.

3. Continuous Measure

Select [Measure Mode] and then set: STAT. Press the button [NIBP] on the front panel or [Start NIBP] to start continuous measure which occurs every 5 minutes.

Press the button [NIBP] on the front panel or [Stop NIBP] and [Stop All] at any time the continuous measure is in process to terminate the continuous measure, and the monitor then returns to the Manual Measure mode.

Attention: if the measure mode is set as continuous measure, when the monitor is turned off and then boot, NIBP measure mode will be back to manual measure.



Warning

- Please regularly check the color, warmth and sensitivity of the animal's distal limbs in the process of measuring blood pressure under Auto and STAT modes. Once any abnormality is found, please relocate the cuff or terminate blood pressure measure.

◆ Interval Setup

Select [Interval] in the menu [NIBP Setup] when the measure mode is Auto, under the auto mode, the monitor automatically and repeatedly conducts NIBP measures according to the preset time intervals.



Attention

- This option is available only when the [Measure Mode] is Auto.

◆ Alarm Setup

Select [Alarm Setup>>] in the menu [NIBP Setup] and then set in the pop-up menu the alarm attributes of each NIBP option parameter.

◆ Start /Stop NIBP Measure

Select this option to start or stop NIBP measure in accordance with the preset mode.

◆ Stop All.

Select this option at any time when the measure is in process to terminate all measuring tasks.

◆ Venipuncture

Users can inflate with NIBP cuff to produce a pressure appropriate for blocking venous vessels and thus assisting venipuncture.

1. Select [Venipuncture>>] in the window [NIBP Setup] and then set [Cuff Pressure] in the pop-up menu for values for venipuncture pressure.
2. Select [Venipuncture]
3. Puncture venous vessel and take blood samples.
4. Select the NIBP button in the front panel or [Stop All.] in the window [NIBP Setup] to deflate the cuff; if it is not deflated, the cuff will be automatically deflated when a preset period has elapsed.

The cuff inflation pressure and the remaining venipuncture time will be displayed on the NIBP parameter region during puncture.

◆ NIBP List Review

Select this option to enter the [NIBP List] window directly. Please refer to 8.4.5 for more details.

6.5.8 NIBP Leakage Test

The system gives no prompt when the leakage test is passed, while a corresponding message will be displayed in the non-invasive blood pressure (NIBP) parameter region if failed:

Leakage Test Procedure:

- 1 Connect the cuff and the monitor's blood pressure port.
- 2 Wrap the cuff onto a column of proper size, as referred to Figure 6.32
- 3 Select [Main Menu]-[Maintenance]-[NIBP Leakage Test], and then 'Leakage Testing...' is displayed in the NIBP parameter region, indicating the system has started conducting leakage detection.
- 4 The system automatically inflates until the pressure is 180 mmHg (24 kPa).
- 5 The system automatically open deflation valve about in 20 seconds, indicating leakage detection is completed.

No prompting message displayed in the NIBP parameter region indicates that the system is not leaking. Prompting message 'GasWay Leak!' displayed in the NIBP parameter region indicates that the system is possibly leaking. Then operator should further check whether a loosened connection exists and re-conduct the leakage detection when a good connection is confirmed. If there is failure prompting message again, please contact manufacturers for maintenance.

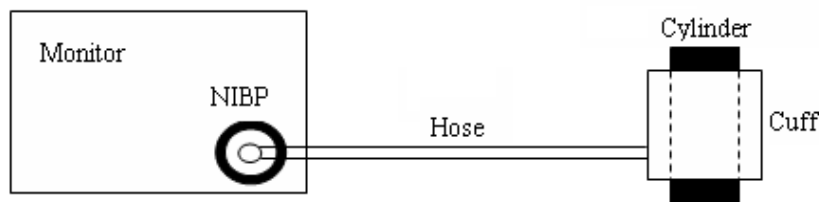

Figure 6.32 NIBP Leakage Test Diagram



Attention

- The [Animal Category] should be set [>20 kg] before conducting NIBP leakage tests.
- Press either the button [NIBP] on the front panel or [Stop NIBP Leakage Test], or [Stop All] and [Stop NIBP] on the interface [NIBP Setup] during leakage test to terminate leakage test.
- Different from EN1060-3 standard, this leakage test method is only operable for user to conveniently detect whether leakage exists during NIBP inflation.



Warning

- NIBP leakage test should be conducted once every two years or when you find readings that are incorrect.

6.5.9 NIBP Accuracy Test

Pressure sensor checking procedures:

1. Use a rigid container with a 500 ml $\pm 5\%$ volume to replace the cuff.
2. Connect a calibrated reference manometer with a precision of at least 0.11 kPa (0.8 mmHg) and a pressurization ball with the NIBP module's pneumatic system by using a T-connector and hoses, as referred to Figure 6.33.
3. Select [Main Menu] - [Maintenance] - [NIBP Accuracy Test].
4. Start NIBP module, enter static manometer measuring mode to start checking.
5. Use the pressurization ball to inflate the pneumatic system until its pressure is 6.66 kPa (50 mmHg) and 26.6 kPa (200 mmHg). The pressure values displayed on the reference manometer and on the monitor should not exceed 0.399 kPa (± 3 mmHg). If their readings exceed 0.399 kPa (± 3 mmHg), please contact our after-sale service technicians.

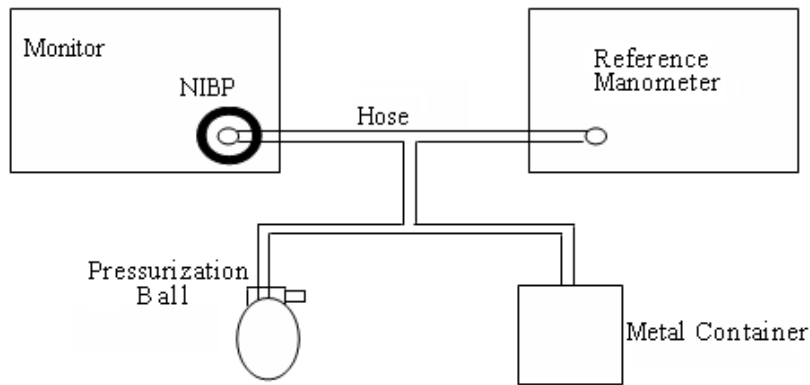

Figure 6.33 NIBP Calibration Diagram

Attention

- Press either the button [NIBP] on the front panel or [Stop NIBP Accuracy Test], or [Stop All.] and [Stop NIBP] on the interface [NIBP Setup] during accuracy test to terminate accuracy testing.

Warning

- NIBP accuracy testing should be conducted once every two years (or in accordance with hospital's procedures), or when you find readings are incorrect.

6.6 Temp

6.6.1 General Description

This series of monitors' measure body temperature by means of a temperature sensor by the following two channels: as Figure 6.34 shows.

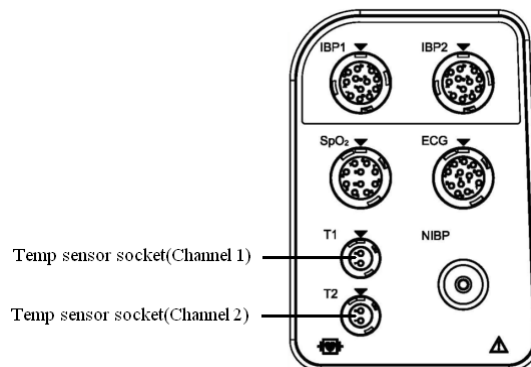

Figure 6.34 Temp Sensor Socket

The monitor supports coin-shaped sensors (body surface), cylindrical sensors (body cavity) and disposable temperature sensors.

- Body surface sensor: generally used to measure the armpit;
- Body cavity sensor: generally used to measure the mouth or rectum;
- Disposable sensor: general used to measure the armpit, mouth or rectum.

6.6.2 Safety Information

Explanation

- When body temperature exceeds the measuring range, alarm is displayed on the screen. Please check if the body temperature sensor is on the animal's body correctly and shift it to the proper positions if needed.
- The measure of body temperature is based on the principle of contact-typed thermal conduction, thus it will takes 1 to 4 minutes before the reading of the measured result is stable starting from the time when the probe contacts with the animal's body; it takes some time before the thermal conduction is balanced.
- Cleaning body temperature sensor: disinfect in alcoholic detergent instead of steam; the disposable temperature probes shouldn't be disinfected or reused repeatedly; while cleaning, hold the probe tip with one hand, and scrub the probe toward the connector with a damp lint-free cloth with the other hand.
- The measure mode of this Temp is adjusted mode.

Attention

- The body temperature sensor and its cables should be handled carefully and they should be loosely wound when not used. The temperature probe and its cables should be handled carefully. The cables may be mechanically damaged when tightened excessively.

Warning

- Before use, please check whether the probe cables are undamaged. When the temperature probe cable is pulled out of its jack, the prompting message will be displayed on the screen that 'T1/T2 Module Disconnected' and alarm sounds.
- Body temperature measure checking should be conducted once every two years (in accordance with hospital-stipulated calibration cycles). Please contact the manufacturers when the calibration cycle is coming.
- Disposable body temperature sensor is only applicable for one animal and reuse is not allowed even it is sterilized.
- Please dispose out-of-service body temperature sensors by following local laws and regulations for this sort of or similar products when they are damaged beyond repair or the service life is due.
- The body surface temperature sensor should be firmly attached on the animal.
- If disposable temperature sensor is used, insert the temperature cable into the jack, and then connect the probe and cable.

6.6.3 Measure Procedure

1. Select appropriate body temperature probe according to animal category and measuring requirements.
2. Insert the body temperature probe into the jacks labeled with 'T1' and 'T2' on the left panel.
3. Adhere the body temperature probe onto animal's body firmly.
4. Confirm that alarm setting is suitable for this animal.
5. Switch on the system power source and start the monitor.

6.6.4 Measure Display

This series of monitors can display T1, T2 and TD (their difference) through two body temperature channels (T1 and T2).

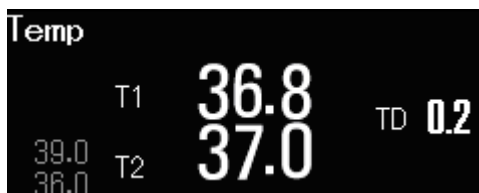

Figure 6.35 Temp Data Display

6.6.5 Temp Unit Setup

Select [Main Menu]-[Maintenance]-[User Maintain>>], input passwords and select [Units Setup>>]-[Temp], the temperature unit can be: °C (degree Celsius) or °F (degree Fahrenheit).

6.6.6 Alarm Setup

Select body temperature parameter region to enter [Alarm Setup] and then set in the pop-up window the alarm attributes of the options T1, T2 and TD.

6.7 IBP (Optional)

6.7.1 General Description

Invasive blood pressure measure is based on the principle of liquid isopiestic pressure transfer to realize direct measure on blood pressure. The arterial blood pressure and its changes are sent to the pressure induction surface of a pressure-sensitive sensor through physiological saline-filled conduits by means of the arterial cannula method; then the arterial blood pressure signal is linearly converted by the pressure-sensitive sensor into electrical signals which are then amplified and filtered via signal amplifying circuits and filter circuits to obtain real-time pressure and pulse wave; then the A/D conversion and relevant manual calibration of zero pressure reference point are performed under the control of the CPU, correlated wave crests and troughs of the above pressure/pulse wave signals are recognized and the pressure and pulse rate (PR) are calculated by adapting a given software algorithm; and finally, the desired systolic pressure, diastolic pressure, mean pressure and PR values are obtained.

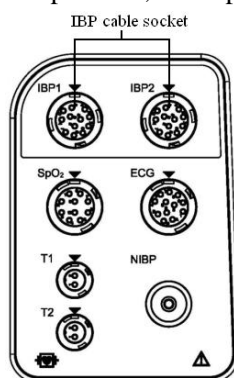

Figure 6.36 IBP Cable Socket

6.7.2 Safety Information

Warning

- Pressure sensors specified in this User manual only are allowed to be used and repeated use of disposable pressure sensors is not allowed.
- Contact of the monitor's sensors and cables with high-frequency surgical equipment should be avoided in order to prevent animals from being burnt by leaked current when the monitor is in contact with high-frequency surgical equipment.
- Contact of accessories with electrically connected metallic parts should be avoided while connecting and using such accessories.
- The working temperature of such accessories should be considered when they are used; and please refer to the Accessory Use Manual for more details.
- If the packaging of the invasive pressure sensor marked for disinfection is damaged, please stop using it and contact the provider of the invasive pressure sensor.
- If the pressure sensor and conduit are damped, please stop using it and contact the provider of the invasive pressure sensor.

Attention

- Before monitoring, please zero-calibrate first.
- Make sure that the pressure sensors are constantly leveled with the heart during monitoring.
- Please continuously inject heparin saline to flush conduits to prevent them from being clogged and maintain the pressure-measuring paths are smooth while connecting the conduits firmly to prevent them from any displacement or separation that would affect the IBP measure.

6.7.3 Monitoring Steps

- 1 Insert the pressure transducer extension cables into the IBP interface on the monitor's left panel.
- 2 Prepare flushing solution.
- 3 Flush the system and deflate the conduits completely. Make sure no bubbles exist in the sensors and valves.
- 4 Connect the pressure tube and animal conduit.
- 5 Place the sensor on the same level with the heart, approximately at the midaxillary line.
- 6 Select correct label.
- 7 Zero-calibrate the sensors. Close the sensor's valves toward the air and open the valve in connection with the animal when the zero-calibration is completed.

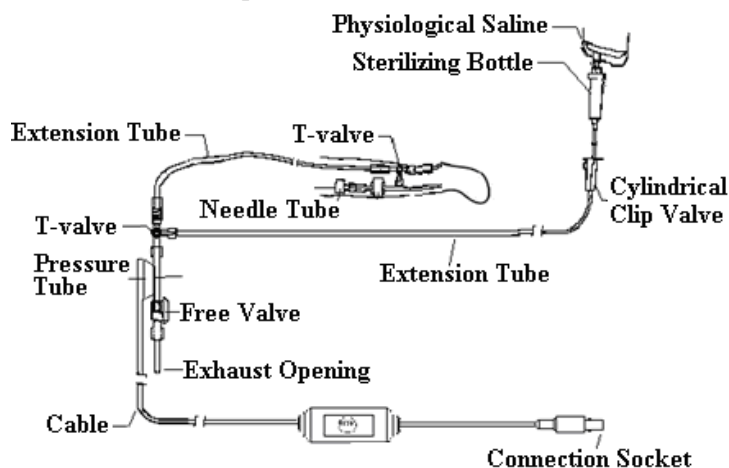

Figure 6.37 IBP Monitor Connection Diagram

Warning

- Please flush the system again with solution if any bubbles are found in the conduit system to avert any possible incorrect pressure readings caused by such bubble.
- The sensors should be leveled with the ears of a sitting animal while measuring his/her intracranial pressure. Incorrect positions may result in incorrect pressure readings.

6.7.4 IBP Display

Pressure waveforms and values are displayed on the IBP measuring interface, and different pressure label correspond to different displayed contents. This manual takes the indicator Art or CVP as an example.

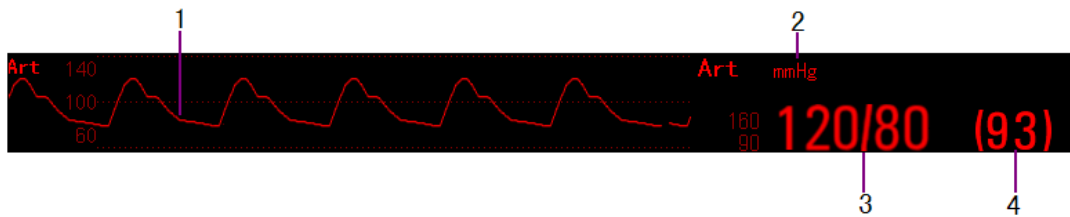

Figure 6.38 IBP Waveform and Data Display

1. Waveform 2. Pressure Unit 3. Systolic Pressure/Diastolic Pressure 4. Mean Pressure

6.7.5 IBP Setup

Select [Main Menu]-[Parameters]-[Art Setup]/ [CVP Setup] (users can set pressure indicators in the setting menu), as referred to Figure 6.39 and Figure 6.40:

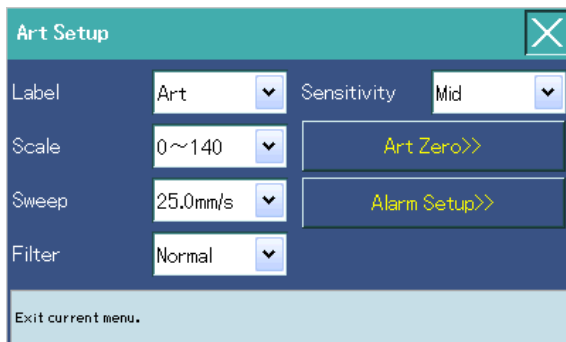

Figure 6.39 Art Setup

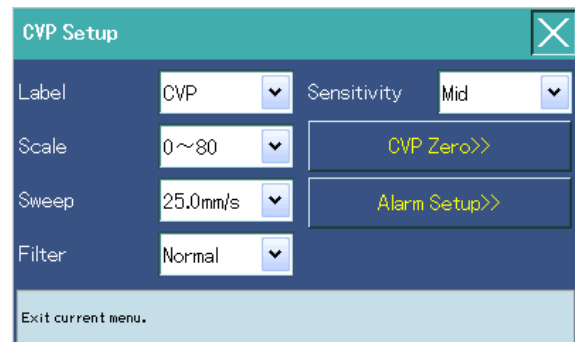

Figure 6.40 CVP Setup

- ◆ **Pressure Label Setup**
Select the IBP parameter region of the renaming indicator and open the setting menu, then select [Label] and find appropriate indicator in this list: Art (Arterial Pressure), PA (Pulmonary Artery Pressure), LAP (Left Atrial Pressure), RAP (Right Atrial Pressure), ICP (Intracranial Pressure), CVP (Central Venous Pressure), and P1/P2 (Dilation Pressure).
- ◆ **Alarm Setup**
Select [Alarm Setup>>] and then set in the pop-up menu the alarm attributes of each IBP option parameter.
- ◆ **Waveform Scale Setup**
Select [Scale], if Auto is chosen, then the upper and lower scales of IBP waveforms automatically adjust as the waveform amplitudes change.
- ◆ **Sweep Setup**
Select [Sweep]: 6.25 mm/s, 12.5 mm/s, and 25.0 mm/s. Bigger values represent higher scanning speeds and wider waveforms.

◆ Filter Setup

Select [Filter], and users can choose: Normal and Smooth.

◆ Sensitivity Setup

The blood pressure values displayed on the monitor are resulting by averaging data sampled within a given period of time. A shorter averaged time represents higher response speed of the monitor yet lower measuring accuracy when the animal's blood pressure values are changing. Contrarily, a longer averaged time represents lower response time of the monitor yet higher measuring accuracy when the animal's blood pressure values are changing. A relatively short averaged time is conducive to analysis of conditions of critical animals that are being monitored.

Select [Sensitivity]: High, Mid and Low, and corresponding averaged time is about: 1s, 8s and 12s.

6.7.6 Sensor Zero-Calibration

The monitor needs an effective zero point to produce accurate pressure data, and please conduct zero calibrations for sensors by following the hospital's rules and regulations. Zero calibration must be done in the following cases:

- New sensors or sensor cables are used.
- The monitor is restarted.
- Reconnect the sensors' cables and the monitor.
- The pressure data of the monitor is suspicious in its accuracy.

Zero Calibration Procedures:

- 1 Connect the pressure sensors, sensor cables and the monitor as referred to Figure 6.41.

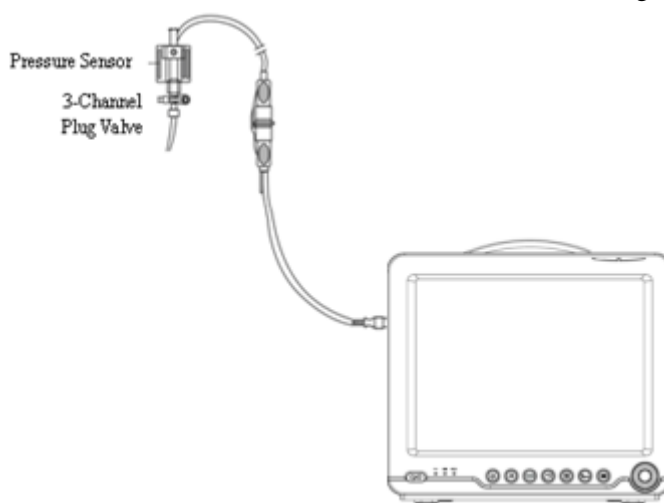

Figure 6.41 IBP Zero Calibration

- 2 Close the animal's valve in the T-valve and expose the sensors to the air through the T-valve.
- 3 Select IBP parameter region, e.g. Art - [Art Setup] - [Art Zero >>] - [Art Zero]. The option [Art Zero] is displayed gray while zero calibrating; calibrated results are displayed when it is done and the [Art Zero] is displayed normally.
- 4 When zero calibration is completed, close the valve toward the air and open the one toward the animal.

6.8 CO₂ (Optional)

6.8.1 General Description

The monitor adapts an infrared absorption technique to measure the CO₂ concentration in the animal's airway. Its principle is based on the CO₂ molecular absorption of infrared optical energy of a certain wavelength and the

absorbed energy is directly related to the CO₂ concentration. When the infrared rays emitted from an infrared source penetrate through a CO₂-containing gaseous sample, part of their energy will be absorbed by the CO₂ in the gaseous sample. A photo detector is employed at the other side of the infrared source to detect the remaining infrared optical energy and convert it to electrical signals. Then the CO₂ concentration in the gaseous sample can be accurately reflected by comparing and regulating the electrical signals and the energy of the infrared source.

Intended use:

It is used to connect with other medical devices to display the CO₂ data in real-time or being derived. It is connected to animal's breathing circuit, so as to monitor the inhaled or exhaled air during the process of anaesthesia, recovery and respiratory disease care. It can be used in the OR, ICU and general wards, with the animals as the subject. The mainstream CO₂ module is often recommended to intubated animals or it can be done through the special mask; while the sidestream CO₂ module is for both intubated and non-intubated animals. It can be connected by using a three-way connector and a sampling tube through the breathing circuit or directly connected through the nasal gas sample.

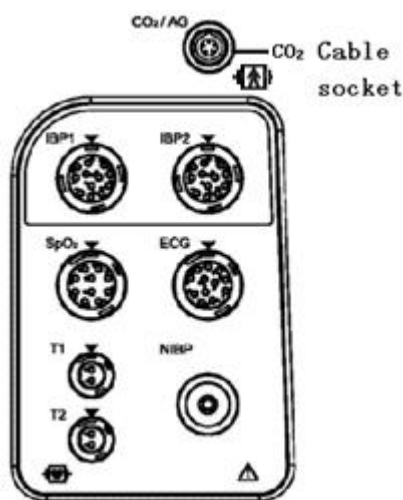

Figure 6.42 CO₂ Cable Socket

There are two CO₂ measuring methods:

1. Main-stream Measure

CO₂ sensors are directly mounted on the airway joint of the animal's respiratory system.

2. Side-stream Measure

The respiratory gas through the animal's respiratory airway is sampled with a constant sampling flow and then is analyzed by the module-inbuilt CO₂ sensors.

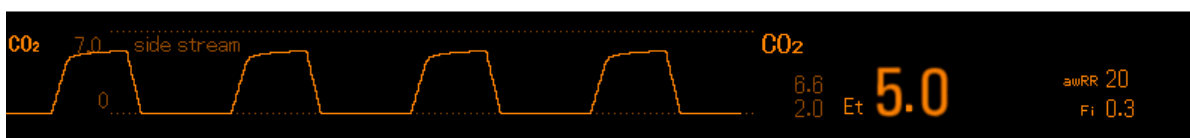

Figure 6.43 CO₂ Wave and Data Display

CO₂ measure provides:

- 1 A CO₂ waveform
- 2 End-tidal CO₂ values (EtCO₂)
- 3 Forced inspiratory CO₂ values (FiCO₂)
- 4 Airway respiration rate (awRR)



Warning

- The CO₂ module can be operated only by authorized or well-trained staff and the operator is required to be familiar with the User manual before using this module.
- Don't use this CO₂ module where anesthetic and other combustible gases are present in the environment to avoid any danger of explosion.
- Electric Shock Danger: disconnect this CO₂ module before cleaning operations. Don't use and contact authorize maintenance personnel once any damage is found.
- Place the module cable carefully to minimize the possibility of animals being wound in it.
- Don't soak the CO₂ module in liquids or sterilize it.
- Animal's breathing system of water vapor can bring condensation and vapor in the sampling tube adapter dewatering device. The operator should observe frequently and intervene water vapor system.



Attention

- Manufacturer-provided accessories ONLY are allowed to be used; use of this module where the ambient temperature is drastically changing may lead to inaccurate measured data, thus it should be used when possible where the ambient temperature is relatively stable.
- The measured data will be slightly affected when anesthesia gases are given to animals, in which case the result can be corrected according to the use protocol or contact the manufacturer.
- Don't use the CO₂ module when it is wet or there is condensation.
- Readings will deviate if you do not allow a warm-up period.
- Extremely high or low CO₂ concentration as a result of severe respiratory failure etc., e.g. the EtCO₂ is lower than 1% or higher than 10%, may cause inaccurate measure.
- Mobile and RF communication devices will affect measure, and use of these instruments where strong electromagnetic interference source exists, such as in the presence of electrosurgical equipment and MRI equipment, may produce inaccurate results; and operation of the monitor in the front of CT equipment may produce inaccurate results.

6.8.2 Side-stream CO₂ Module



Warning

- Repeatedly using, dismantling, cleaning or sterilizing sample tubes will affect system functions and performance and put users or animals at risk.
- The sampling tube should be replaced when too much secretion is present on it.
- Don't use >20 kg/10~20 kg oriented sampling tubes for <10 kg, otherwise, unused space will be in the animal's loops.
- Don't use CO₂ module for animals that are unable to have 50ml/min±10ml/min sampling gases taken from their respiratory loops.



Attention

- Since the sampling tube has a certain length, it takes time for the gases to go through the tube and a certain delay results from the measure start to displaying on the screen of the waveforms and measured results.
- Make sure that the sampling tube is smooth, otherwise, inaccurate measure and reduction of the

module's service life will occur.

- Excessive negative or positive pressure in the animal's tube may affect sampling flow rate.
- Please insert the sampling tube before connecting a T-valve in the respiratory loop. Please remove the T-valve from the respiratory loop before removing the sampling tube.

◆ **Brief Description on Measure**

This series of monitors allow selection of different side-stream CO₂ modules, and the measuring method for side-stream CO₂ module will be discussed in the following by taking the Kingst Side-Stream KM7002-V33 module as the example.

1. Attach a water tank to a base firmly and connect the CO₂ measuring assembly, shown in Figure 6.44

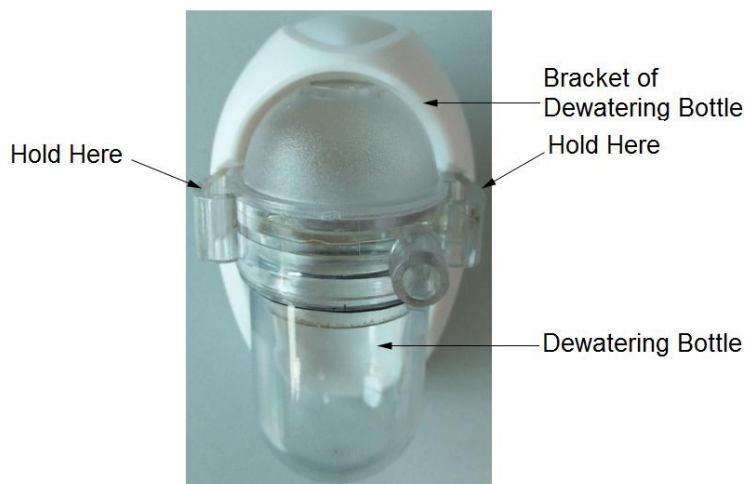

Figure 6.44 Dewatering Bottle Attaching and Detaching Diagram

2. As shown in Figure 6.44, hold the two ends of dewatering bottle and gently pull the tube down to remove water.
3. As shown in Figure 6.45, connect one end of the sampling tube with the dewatering bottle's threaded nipple and the other end with the breathing tube of the animal's breathing machine or anesthesia machine or with the threaded nipple having a diameter of $\phi 10\text{mm}$ in other airways (a section of connecting tube having a $\phi 10\text{mm}$ threaded nipple needs to be connected if such source nipple is not available), or directly fixing the sampling tube to the animal's nostrils by using adhesive tape.

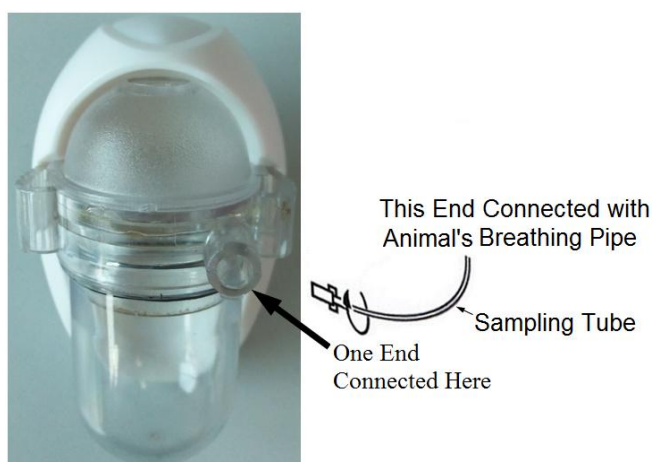

Figure 6.45 Dewatering Bottle Connecting Diagram



Attention

- Pay close attention to the water level in the dewatering bottle and make sure it is below the highest level; and exchange dewatering bottles to prevent water entering the module.

- It's better not to connect a water tank and set the CO₂ module in stand-by mode when the CO₂ module is not in use to prolong the service life of the water tank and module.
- The filled dewatering bottles must be quickly replaced and exchanged to prevent any damage to the module.
- Don't use this module for expiratory gas measure when a dewatering bottle is not connected, for the moist expiratory gases may cause errors to the measure and may shorten the module's service life due to accumulation of humid gases.

6.8.3 Main-stream CO₂ Module



Warning

- Do not use in the presence of flammable anesthetics or other flammable gasses. Use of the CAPNOSTAT5 sensor in such environment may present an explosion hazard.
- Electrical Shock Hazard: always disconnect the CAPNOSTAT5 sensor before cleaning. Do not use if it appears to have been damaged. Refer servicing to qualified service personnel.
- Do not position the sensor cables or tubing in any manner that may cause entanglement or strangulation.
- Reuse, disassembly, cleaning, disinfecting or sterilizing the single animal use CO₂ airway adapters may compromise functionality and system performance leading to a user or animal hazard. Performance is not guaranteed if an item labeled as single animal use is reused.
- Inspect the CO₂ airway adapters for damage prior to use. Do not use the CO₂ airway adapters if they appear to be damaged or broken.
- Replace the CO₂ airway adapters if excessive secretions are observed.
- If the CO₂ waveform (Capnogram) appears abnormal, inspect the CO₂ airway adapters and replace if needed.
- Monitor the CO₂ waveform (Capnogram) for elevated baseline. Elevated baseline can be caused by sensor or animal problems.
- Periodically check the CAPNOSTAT5 sensor and tubing for excessive moisture or secretion buildup.
- Do not operate the CAPNOSTAT5 sensor when it is wet or has exterior condensation.



Attention

- Use only accessories provided by manufacturer.
- Do not sterilize or immerse the CAPNOSTAT5 sensor in liquids.
- Do not clean the CAPNOSTAT5 sensor and accessories except as directed in this manual.
- It is recommended that the CO₂ sensor be removed from the circuit whenever an aerosolized medication is delivered. This is due to the increased viscosity of the medications which may contaminate the sensor windows, causing the sensor to fail prematurely.
- Do not apply excessive tension to the CAPNOSTAT5 sensor cable.
- This product and its accessories are latex free.
- After the life cycle of the CAPNOSTAT5 sensor and its accessories have been met, disposal should be accomplished following national and local requirements.
- Nitrous oxide, elevated levels of oxygen and helium can influence the CO₂ measurement. Please setup gas compensation according to actual state.
- Barometric pressure compensation is required to meet the stated accuracy of the CAPNOSTAT5

sensor.

- Do not place the combined CO₂ sensor between the ET tube and the elbow (<10~20 kg or >20 kg circuit), as this may allow animal secretions to block the adapter windows.
- Position the combined CO₂ sensor with its windows in a vertical and not a horizontal position: this helps keep animal secretions from pooling on the windows.

◆ Preparing to Measure CO₂ (Mainstream, CAPNOSTAT5)

1. Attaching the CAPNOSTAT 5 sensor cable.

To attach the CAPNOSTAT 5 sensor cable, plug the cable into CO₂ socket on the left panel of monitor by matching the key on the cable to the key on the connector.



Attention

- To remove the sensor cable from the monitor, grasp the collar surrounding the cable and pull up.

2. Selecting a mainstream airway adapter.

Select an airway adapter based on the animal's size, ET tube diameter and monitoring situation. For more information refer to the following or contact manufacturer.

Table 6.4 Airway Adapter Type

Airway Adapter Type	ET Tube Diameter
SPU*10~20 kg / > 20 kg	> 4.0 mm
> 20 kg (Reusable)	> 4.0 mm
SPU* < 10kg./0~20 kg	≤4.0 mm
< 10 kg. (Reusable)	≤4.0 mm

*SPU=Single Animal Use

3. Attaching the airway adapter to the CAPNOSTAT 5 sensor.

Before attaching the airway adapter to the CAPNOSTAT 5 sensor, verify that the airway adapter windows are clean and dry. Clean or replace the adapter if necessary.

Follow these steps:

- 1) Align the arrow on the bottom of the airway adapter with the arrow on the bottom of the sensor.
- 2) Press the sensor and airway adapter together until they click.
- 3) Wait for the airway adapter and sensor to warm up.

The monitor will display the 'Sensor Warm Up' message for approximately one minute while the sensor and adapter warm to operating temperature. The message disappears when the sensor is ready for use.



Attention

- Warm up time varies with ambient temperature of the module.

4. Zero

Please refer to chapter 6.8.5

5. Attaching the airway adapter to the airway circuit.

After zeroing, attach the airway adapter to the airway circuit as follow

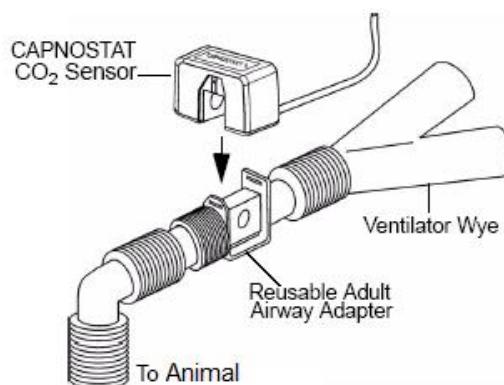

Figure 6.46 Attach Airway Adapter to Airway Circuit

6. Ensure the airway air-proof and ready to measure.

6.8.4 CO₂ Setup

◆ Open CO₂ Menu

Users can open the [CO₂ Setup] through the following three means:

- Select CO₂ Parameter Region to open [CO₂ Setup].
- Select CO₂ waveform region to open [CO₂ Setup].
- [Main Menu]-[Parameters]-[CO₂ Setup].(Different interfaces are presented when different CO₂ modules are installed by users, thus users can set to suit the actual installed modules)

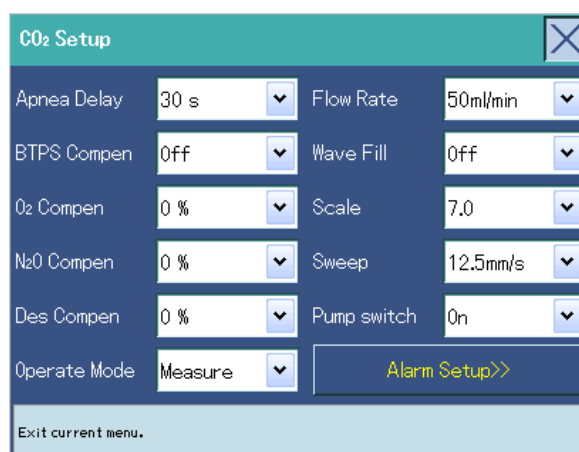
Figure 6.47 CO₂ Setup

◆ Apnea Delay

Set apnea delay time to trigger the monitor's alarm in case the animal's asphyxia time exceeds the preset values.

◆ BTPS Compen

The Main-Stream CO₂ sensors are built with heating elements to prevent water from condensing, thus, it is unnecessary to set temperature compensation when the Main-Stream module is in use. While for Side-Stream modules, whether or not to start or stop temperature compensation should be judged by actual conditions.

◆ Gas Compen



Warning

- Please set each compensation to meet different actual conditions, otherwise, the measured results may deviated greatly and result in misdiagnosis.

By taking KM7002-V33 Kingst side-stream module as example:

- [O₂ Compen]
- [N₂O Compen]
- [Des Compen]

◆ **Operate Mode**

Select [Operate Mode]: Measure and Standby. In the standby mode, the sampling pump is automatically closed and the measure mode is automatically open, but users can manually close the pump in this mode and resetting the pump speed will forcibly open the closed pump.

The Standby modes of the CO₂ module and the monitor are correlated.

- The CO₂ module enters the Standby model when the monitor enters this mode.
- The CO₂ module exits the Standby model when the monitor exits this mode.
- The monitor is not affected when the CO₂ module enters or exits the Standby mode.

◆ **Flow Rate**

The sampling rate of the respiratory gases through the animal's loop can be altered by setting different pump speeds for the Side-Stream CO₂ module.

Select [Flow Rate]: 50 ml/min, 100 ml/min and 150 ml/min.



Warning

- The animal's capacity should be taken into account to select the pump speed suitable for the animal while setting the flow rate.

◆ **Wave Fill**

Select [Wave Fill]: Off or On. Set the areas below the CO₂ waveforms to be displayed filled or not.

◆ **Scale**

Tune the scale on the waveforms, and the wave amplitudes will change.

◆ **Sweep**

Select [Sweep]: 6.25 mm/s, 12.5 mm/s and 25.0 mm/s. Set the waveform scanning speed.

◆ **Pump Switch**

Select [Pump Switch]: Off or On.

6.8.5 Zero

The purpose of zero calibration is to eliminate the influence of baseline drift on results to guarantee the accuracy of the measured results in the process of measuring.

◆ **Side-stream**

The side-stream CO₂ module automatically calibrates zero when necessary. Users can also manually zero-calibrates as desired: [User Maintain>>] - [CO₂ Maintenance>>] - [Zero]. Zero calibration requires disconnecting the animal airway.



Attention

- Don't perform zero calibration when the temperature is not stable.

◆ Main-stream

The main-stream CO₂ module need zero calibration in the following cases:

- The airway adapter is exchanged.
- The sensors is re-connected with the module.
- The gas readings are found having errors.
- The system prompts 'CO₂ Need Zero'.

In this case, please check the airway adapter and make sure its adapter window is not blocked by mucus, etc. Cleaning or adapter replacement is needed when a blockage is found.

The zero calibration steps are as follows:

- 1 Connect the sensor with the CO₂ module.
- 2 Select CO₂ parameter region and choose [CO₂ Setup]-[Operate Mode], and set [Measure].
- 3 When warming-up is done, mount the sensor on a clean and dry airway adapter. The adapter should be open to the air and all CO₂ sources should be isolated, including breathing machine, animal's respiration and operator's respiration.
- 4 Select [CO₂ Maintenance>>] in the menu [User Maintain>>]-[Zero], and 'CO₂ Zero Progress' is prompted on the screen.
- 5 The prompting message disappears when the zero calibration is completed.



Attention

- The module must be zero-calibrated when the system prompts that CO₂ measure is over the time allowed. The module should be zero-calibrated regularly after a long use period.
- Zero calibration must be performed by specialized technicians.



Warning

- Incorrect zero calibration may cause inaccurate measured data.

6.8.6 Calibrate



Explanation

- Despite being unnecessary for regular calibrations, the side-stream module needs calibrating once a year or when the measured values have obviously deviated.
- The main-stream module doesn't need calibrating.

The calibrator includes:

Standard CO₂ gas having a concentration of $6 \pm 0.5\%$, a T-joint and an airway.

Calibration Procedures:

1. Make sure that the side-stream CO₂ module has been started and warmed up.
2. Conduct airway check and leakage detection to make sure that airway is not leaking.
3. Set [Maintenance]-[User Maintain>>]-[CO₂ Maintenance>>].
4. Select [Zero] in the menu [CO₂ Maintenance].
5. Connect as shown in Figure 6.48 when zero calibration is successful.

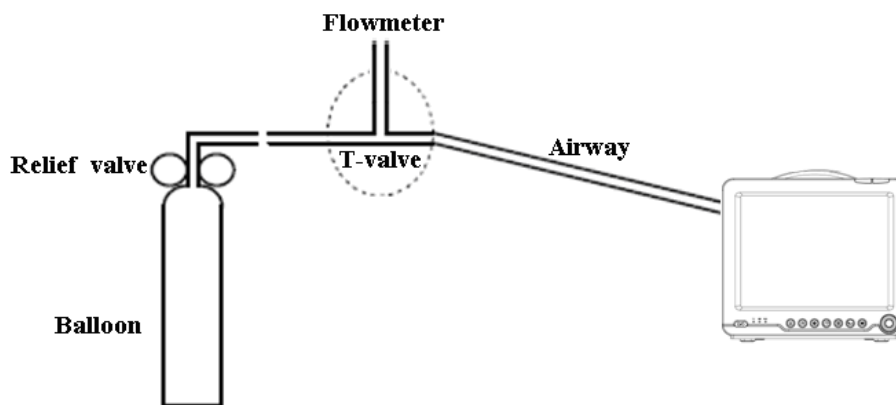

Figure 6.48 Calibration Diagram

6. Open and regulate throttle valve switch until the flow indicated by the flowmeter is 10ml/min-50ml/min and maintains stable.
7. Select a concentration equal to that of the introduced gases in the menu [CO₂ Maintenance].
8. The currently measured CO₂ concentration will be displayed in the menu [CO₂ Maintenance]. Select [Calibrate] to calibrate CO₂ module until the measured CO₂ concentration is stable.
9. The message 'Calibrate Successfully' is displayed on the menu [CO₂ Maintenance] when the calibration is successful, and 'Calibrate Failure' is displayed when the calibration is not successful in which case re-calibration is needed.



Warning

- It is suggested that calibration is conducted by users with the help of authorized technicians, since incorrect calibration may yield incorrect results.

6.8.7 Influencing Factors of Measure

- Leakage or internal leakage of sampled gases.
- Mechanical impact.
Circulating pressure above 10 kPa (75 mmHg and 100 cmH₂O) and abnormal changes in airways.
- Other interference sources.

6.8.8 Faulty Handling

Please conduct the following checks when the side-stream CO₂ module's sampling system runs abnormally:

1. First, check whether the sampling tubes are twisted. If not, please remove the sampling tubes from the water tank, and if there is prompt on the screen indicating that the airway is abnormal, it means that the water tank is clogged and needs to be changed.
2. In case there are no prompts of abnormality, it means that the sampling tubes are clogged and needs to be changed.

6.8.9 Emissions

Use an exhaust pipe and the vent on the module connected to the sample gas emissions to the waste processing system.

Warning

- Anesthetic: the sidestream CO₂ module, to measure the use of anesthetics or recently used anesthetic animals, the vent on the module must be connected to the exhaust gas treatment system, anesthesia machine or ventilator, to avoid medical personnel inhalation anesthetic.

6.9 C.O. (Optional)

6.9.1 General Description

Warning

- C.O. monitoring is restricted to animals > 20 kg only.

The cardiac output (C.O.) function invasively measures cardiac output and other hemodynamic parameters by using the thermodilution method. A cold solution of known volume and temperature is injected into the right atrium through the proximal port of a pulmonary artery (PA) catheter. The cold injectable solution mixes with the blood in the right ventricle and the change in blood temperature is measured with a thermistor at the distal end of the catheter in the pulmonary artery. The C.O. Cable Socket is shown as follows:

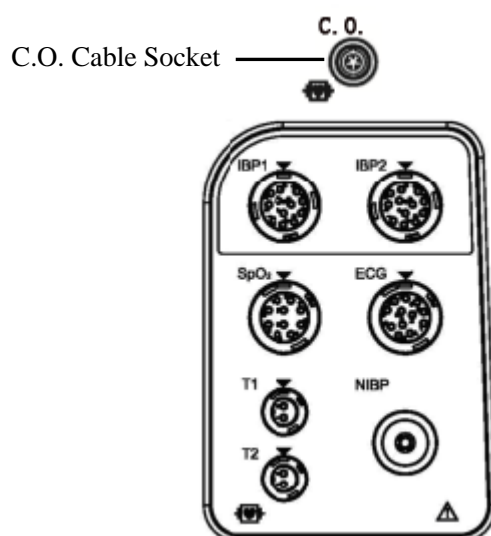

6.9.2 Influencing Factors of Measurement

- temperature of injectable solution
- volume of injectable solution
- animal's baseline blood temperature
- animal's inspiratory/expiratory cycle
- the extent of proximity of the distal end of catheter and the lung
- the PA catheter itself
- the animal heart rate and hemodynamic status
- any other rapid IV solutions which are injected while the C.O. measurement is being performed

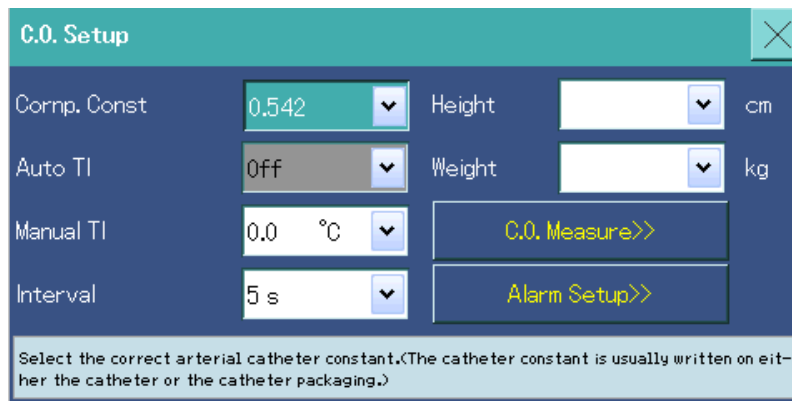

- [Comp. Const]: Make sure that the correct computation constant is entered. When a new catheter is used, the computation constant should be adjusted in accordance with the manufacturer's instructions for use.
 - [Auto TI]: When [Auto TI] is enabled, the injectate temperature is automatically obtained.
 - [Manual TI]: When [Auto TI] is disabled, you can enter the injectate temperature in the [Manual TI] field.
 - [Height] and [Weight]: The animal height and weight will be imported automatically from the animal information. If animal height and weight in the animal information have not been entered, they should be entered manually here and they will be automatically exported to the animal information.
 - [Interval]: To ensure accurate measurements, a certain period of time should be allowed for the blood temperature to become stable before starting a new measurement. To set the interval between two measurements, in the [C.O. Setup] menu, select [Interval] and enter an appropriate time period. Every time when a measurement is completed, the monitor will count down the time period and display prompt message of remaining time.
4. In [C.O. Setup] menu, select [C.O. Measure] to enter the C.O. measurements window. The temperature curve is displayed and the C.O. value is inversely proportional to the area under the curve. In order to achieve a reliable C.O., a series of measurements must be carried out. The monitor can store 6 measurement results, and the user can select among these results to achieve average C.O..

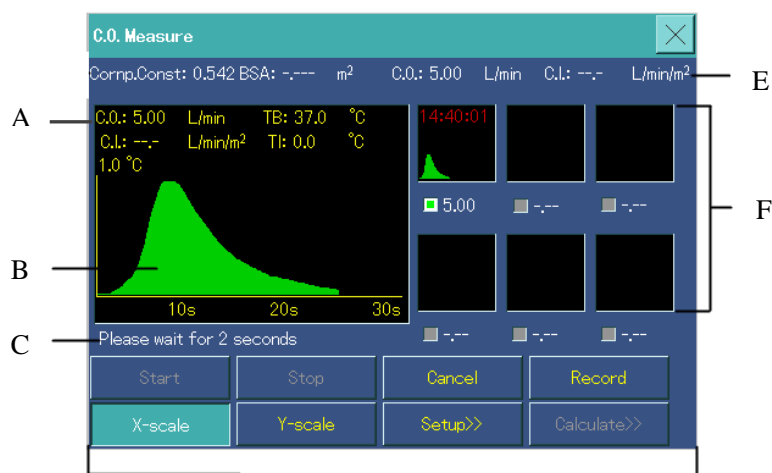

- A. Results of current measurement
- B. Temperature curve of current measurement
- C. Prompt message area
- D. Function buttons are displayed.

[Start]: Select [Start] to start a C.O. measurement.

[Stop]: Select [Stop] to stop the current measurement if the measurement is too long.

[Cancel]: During the current measurement, select [Cancel] to cancel the measurement output and stop the current measurement. After a measurement, select [Cancel] to delete the measured output.

[Record]: Select [Record] to print out the most recently-measured output.

[X-Scale]: Select [X-Scale] to adjust the scale of the X-axis. Options are 30 s and 60 s.

[Y-Scale]: Select [Y-Scale] to adjust the scale of the Y-axis. Options are 0.5 °C, 1 °C and 2.0 °C.

[Setup >>]: Select [Setup >>] to access the [C.O. Setup] menu.

E. Averaged C.O. and C.I.

F. Measurement windows

5. When you see the message [Ready for New Measurement], select the [Start] button and then inject the solution within 4 seconds, and the curve will be displayed. After the measurement, the curve and results will enter measurement windows. At last, the monitor will prompt you to wait for a certain period of time before starting a new measurement.
6. Repeat step 5 until you decide to finish. Select by checking under the measurement windows, and the monitor will automatically calculate and display the averaged C.O. and C.I.

If you perform more than six measurements, the oldest output will be deleted and the new output will enter.

Before an injection, turn off the stopcock to the PA catheter and turn on the stopcock to the injectable solution, and then draw the injectable solution into the syringe.

When the injectable solution enters the syringe, turn off the stopcock to the injectable solution and turn on the stopcock to the PA catheter, and then start an injection.

After the measurement is completed, turn off the stopcock to the PA catheter and turn on the stopcock to the injectable solution.



Attention

- During the C.O. measurement, blood temperature alarms are inactive.

6.9.4 Understanding the C.O. Display

The C.O. measurement is displayed on the monitor as numeric C.O. and TB in the C.O. parameter window as shown below. To enter the [C.O. Setup] menu, select the C.O. parameter window.



6.9.5 Changing C.O. Settings

◆ **Setting the Temperature Unit**

In the [User Maintain] menu, select [Temp Unit] to toggle between [°C] and [°F].

◆ **Setting the C.O. Alarm**

In [C.O. Setup] menu, select [Alarm Setup>>] to enter the C.O. alarm window to set the alarm.

6.9.6 Measuring the Blood Temperature

The blood temperature is measured by a temperature sensor at the distal end of the catheter in the pulmonary artery. During C.O. measurements, blood temperature alarms are inactive to avoid false alarms during measurements and will become active automatically as soon as the C.O. measurements finish.

6.10 AG anesthetic gas (optional)

6.10.1 Overview

Anesthetic gas module measures the concentration of the gas in the principle of absorption characteristics of gas to infrared. The gases that can be measured by anesthetic gas module can absorb infrared light, and each gas has its own absorption characteristics. The gas is transferred to a sample chamber, and the infrared filter selects the infrared light of a specific band to pass through the gas. To measure several kinds of gases, several infrared filters are required. In a given volume, the higher the gas concentration, the more infrared light is absorbed, the less infrared light is transmitted through the gas. The gas concentration can be calculated by measuring the transmission amount of infrared light.

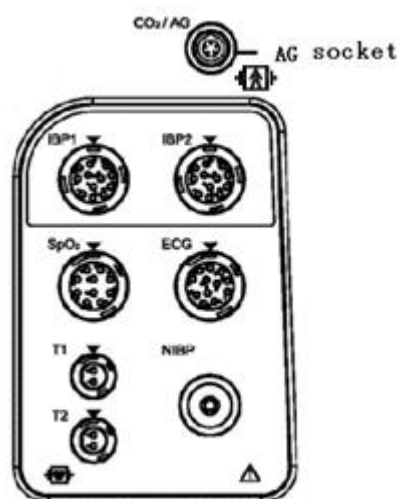

Figure 6.49 AG Cable Socket



Attention

- The AG module configuration automatic atmospheric pressure compensation.

6.10.2 AG Display

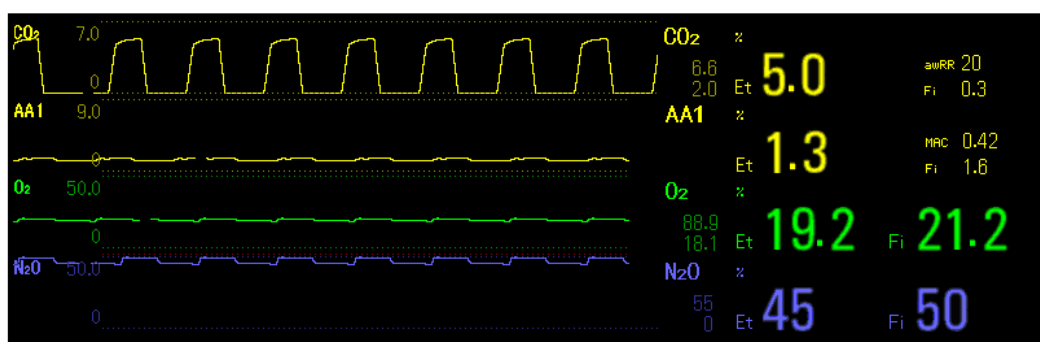



Figure 6.50 AG Display

AG module can display all measured waveforms and parameters on the monitor screen, such as:

- CO₂: O₂, N₂O and AA1 waveform.
- awRR: airway respiration rate.
- MAC: minimum alveolar concentration.
- CO₂, O₂, N₂O and AA1: end-tidal (Et) and respiratory (Fi) values.

Where, AA1 represents one anesthetic gas of Des (desflurane), Iso (isoflurane), Enf (enflurane), Sev (sevoflurane) and Hal (halothane).

AA1 waveform displays the main anesthetic gas waveforms.



Warning

- Do not use flammable and explosive anesthetics such as ether and cyclopropane, so as to prevent explosion.

6.10.3 MAC Value

Minimum alveolar concentration (MAC) is a standard for comparing the potency of inhalation anesthetics. 1 MAC represents the end-tidal concentration of an agent (at sea level) that, in 50 percent of a tested population, prevents gross muscular movement in response to a painful, standardized stimulus.

The MAC value may be calculated and displayed by using end-tidal (Et) gas concentrations according to the following formula:

$$MAC = \frac{\%Et(AA1)}{X(AA1)} + \frac{\%Et(AA2)}{X(AA2)} + \frac{\%Et(N2O)}{100}$$

$$X(AA): \text{HAL}=0.75\%, \text{ENF}=1.7\%, \text{ISO}=1.15\%, \text{SEV}=2.05\%, \text{DES}=6.0\%$$



Attention

- Above formula does not consider the altitude.

6.10.4 Mainstream AG module

◆ Intended Use

The IRMA main stream multi-gas probe is intended to be connected to other medical devices for display of real time and derived monitoring data of CO₂, N₂O, and the anesthetic agents Halothane, Enflurane, Isoflurane, Sevoflurane and Desflurane.

It is intended to be connected to an animal breathing circuit for monitoring of inspired/expired gases during anesthesia, recovery and respiratory care. It may be used in the operating suite, intensive care unit and animal room settings for >20 kg, 10~20 kg and <10 kg animals.

It is not intended to be used as the only means of monitoring an animal. It shall always be used in

combination with other vital signs monitoring devices and/or professional human judgments of animal condition. The IRMA probe is intended to be used by trained and authorized health care professionals only.

◆ System Assembly Instruction

Setup

- 1 Plug the IRMA connector into the IRMA input of <host device> and switch the power on.
- 2 Snap the IRMA probe on top of a new IRMA airway adapter. It will click into place when properly seated.

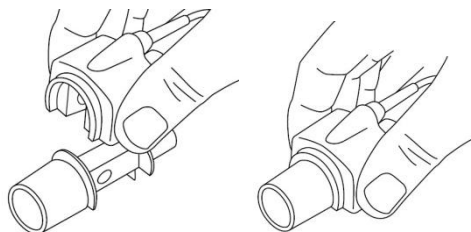

Figure 6.51

- 3 Depending on IRMA model, perform the following

IRMA AX+	IRMA CO ₂
Wait minimum 30 seconds Perform zeroing (refer to section Zeroing Procedure)	Perform zeroing (refer to section Zeroing Procedure) if gas readings does not show 0% or if an unspecified accuracy message is displayed

- 4 A green LED indicates that the IRMA probe is ready for use.



Figure 6.52

- 5 Connect IRMA/airway adapter 15 mm male connector to the breathing circuit Y-piece.



Figure 6.53

- 6 Connect the IRMA/airway adapter 15 mm female connector to the animal's endotracheal tube.

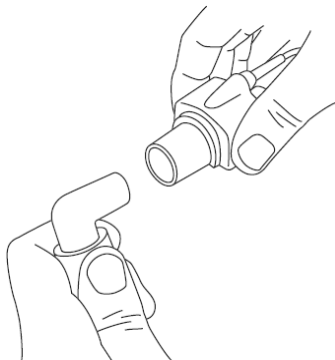

Figure 6.54

- 7 Alternatively, connect an HME (Heat Moisture Exchanger) between the animal's endotracheal tube and the IRMA probe. Placing an HME in front of the IRMA probe protects the airway adapter from secretions and effects of water vapor and eliminates the need of changing the adapter. It allows free positioning of the IRMA probe as well.

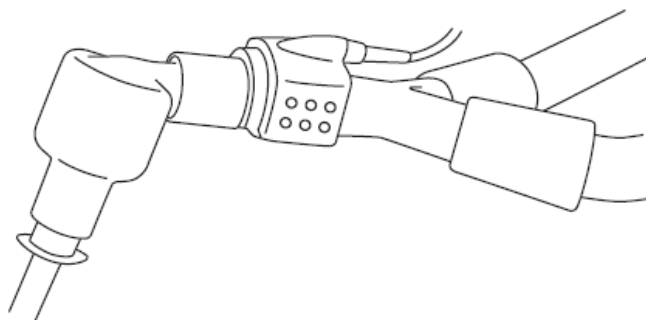

Figure 6.55

- 8 Unless the IRMA probe is protected with an HME always position the IRMA probe with the status LED pointing upwards.

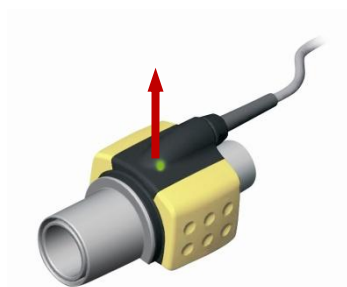

Figure 6.56

◆ **Placement of IRMA Probe**

When connecting IRMA probe to an infant animal circuit it is important to avoid a direct contact between the IRMA probe and the animal's body.

If, for whatever the reason, the IRMA probe is in direct contact with any parts of the animal's body an insulation material shall be placed between the IRMA probe and the body.



Warning

-
- The IRMA probe is not intended to be in animal contact.

◆ **Pre-use Check**

Prior to connecting the IRMA airway adapter to the breathing circuit, verify gas readings and waveforms on the monitor before connecting the airway adapter to the animal circuit.

Perform the tightness check of the animal circuit with the IRMA probe snapped on the IRMA airway adapter.

◆ **Zeroing Procedure**



Warning

- Incorrect probe Zeroing will result in false gas readings.

In order to secure high precision of the IRMA probe measurements the following zeroing recommendations should be followed.

Zeroing is performed by snapping a new IRMA airway adapter onto the IRMA probe, without connecting the airway adapter to the animal circuit, and then using the host instrument to transmit a Zero reference command to the IRMA probe.

Special care should be taken to avoid breathing near the airway adapter before or during the Zeroing procedure. The presence of ambient air (21% O₂ and 0% CO₂) in the IRMA airway adapter is of crucial importance for a successful Zeroing. If a “ZERO_REQ” alarm should appear directly after a Zeroing procedure, the procedure has to be repeated.

Always perform a pre-use check after Zeroing the probe.

IRMA CO₂ Probes:

Zeroing needs to be performed ONLY when an offset in gas values is observed, or when an unspecified accuracy message is displayed.

Allow 10 seconds for warm up of the IRMA CO₂ probe after power on and after changing the IRMA airway adapter before proceeding with the Zeroing Procedure. The green LED on the probe will be blinking for approximately 5 seconds while zeroing is in progress.

IRMA AX+ Probes:

Zeroing should be performed every time the IRMA airway adapter is replaced, or whenever an offset in gas values or an unspecified gas accuracy message is displayed.

Allow 30 seconds for warm up of the IRMA AX+ probes after power on and after changing the IRMA airway adapter before proceeding with the Zeroing Procedure. The green LED on the probe will be blinking for approximately 5 seconds while zeroing is in progress.

◆ **Alarms**

Include a description of the status LED situated on the IRMA probe:

Table 6.5 Alarms Status

Indication	Status
Steady green light	System OK
Blinking green light	Zeroing in progress
Steady blue light	Anesthetic agent present

Steady red light	Sensor error
Blinking red light	Check adapter



Attention

- Valid for IRMA AX+ only.

◆ **Cleaning**

The IRMA probe can be cleaned using a cloth moistened with maximum 70% ethanol or maximum 70% isopropyl alcohol.

Remove the disposable IRMA Airway Adapter prior to cleaning the IRMA probe.



Attention

- The IRMA Airway Adapters are non-sterile devices. Do not autoclave the adapters as this will damage them.
- Never sterilize or immerse the IRMA probe in liquid.

◆ **Preventive maintenance**

Gas readings should be verified at regular intervals with a reference instrument or by conducting the gas span check as manufacturer suggestion. The suggested interval is once every year.

◆ **Warnings and Attentions**



Warning

- The IRMA probe is intended for use by authorized and trained medical personnel only.
- The IRMA probe must not be used with flammable anesthetic agents.
Disposable IRMA airway adapters shall not be reused. Reuse of the single use adapter can cause cross infection.
- Used airway adapters shall be disposed of in accordance with local regulations for medical waste.
- Do not use the IRMA >20 kg/10~20 kg airway adapter with <10 kg as the adapter adds 6 ml dead space to the animal circuit
- Do not use the IRMA airway adapter with >20 kg as this may cause excessive flow resistance.
- Measurements can be affected by mobile and RF communications equipment. It should be assured that the IRMA probe is used in the electromagnetic environment specified in this manual.
- Do not place the IRMA airway adapter between the endotracheal tube and an elbow as this may allow animal secretions to block the adapter windows and result in incorrect operation.

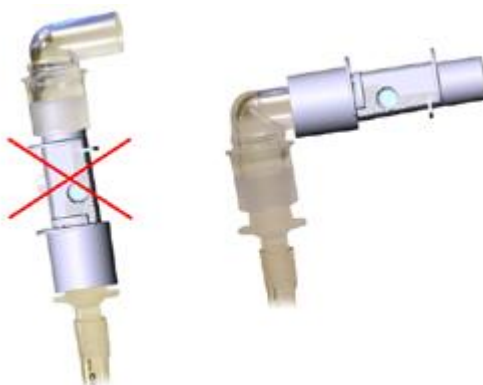

Figure 6.57

- Do not use the IRMA airway adapter with metered dose inhalers or nebulized medications as this may affect the light transmission of the airway adapter windows.
- The IRMA probe is intended only as an adjunct in animal assessment. It must be used in conjunction with other assessments of clinical signs and symptoms.
- Incorrect probe zeroing will result in false gas readings.
- Replace the adapter if rainout/condensation occurs inside the airway adapter.
- Use only PHASEIN manufactured IRMA airway adapters.
- The IRMA probe is not intended to be in animal contact.

**Attention**

- Never sterilize or immerse the IRMA probe in liquid.
- Do not apply tension to the probe cable.
- Do not operate the IRMA probe outside the specified operating temperature environment.
- (U.S.): federal law restricts this device to sale by or on the order of a physician.
- The IRMA Airway Adapters are non-sterile devices. Do not autoclave the adapters as this will damage them.

6.10.5 Sidestream AG module**◆ Intended Use**

The ISA product family consists of three types of sidestream gas analyzers (ISA CO₂, ISA AX+ and ISA OR+), which are intended to be connected to other medical host devices for monitoring of breath rate and the following breathing gases:

ISA CO₂: CO₂

ISA AX+: CO₂, N₂O, Halothane, Isoflurane, Enflurane, Sevoflurane and Desflurane

ISA OR+: CO₂, O₂, N₂O, Halothane, Isoflurane, Enflurane, Sevoflurane and Desflurane

ISA CO₂, ISA AX+ and ISA OR+ are intended to be connected to an animal breathing circuit for the monitoring of inspired/expired gases during anesthesia, recovery and respiratory care. The intended environment is the operating suite, intensive care unit and animal room. ISA CO₂ is also intended to be used in road ambulances.

They are only intended to be connected to medical devices approved by PHASEIN AB.









Attention

- An ISA sidestream gas analyzer should never be used as the only means of monitoring an animal.
- An ISA sidestream gas analyzer shall only be connected to medical devices approved by PHASEIN.

◆ Symbols

Table 6.6 Symbols

Symbol	Title	Explanation
	Instructions for use	Consult instructions for use
	Catalog number	/
	Serial number	/
	Batch code	/
	Year of manufacture	/
	Use by date [YYYY-MM-DD]	The device should not be taken into operation after the date accompanying the symbol.
	Temperature limitation	/
	Pressure limitation	/
	Humidity limitation	/
	Do not re-use	Nomoline and nomoline airway adapter set are intended for single animal use
	Biohazardous waste	Nomoline family sampling lines shall be disposed as biohazardous waste
	For EU only: Waste Electrical and Electronic Equipment (WEEE)	For EU only: electrical and electric equipment shall be collected and recycled in accordance with (Directive 2002/96/EC)
	Conformité Européenne	Complies with 93/42/EEC medical device directive when connected to medical devices approved by PHASEIN AB.
	IP classification indicating level of water protection	“Splash-proof”
	Rx only	(US Only) Caution: federal law restricts this device to sale by or on the order of a licensed

Symbol	Title	Explanation
		healthcare practitioner.
	CO ₂	ISA equipped to measure CO ₂ only
	Multigas (AX+ or OR+)	ISA equipped to measure multiple gases
	Sigma Multigas Technology	The product is fitted with PHASEIN Sigma Multigas Technology
	Gas Inlet	/
	Gas Outlet	/
	Defibrillation-proof type BF applied part	The applied part of ISA is the nomoline family sampling line

◆ Analyzer System Setup

To set up the <host device> for gas analysis, follow these steps:

- 1 Securely mount the ISA analyzer.



Figure 6.58

- 2 Connect the ISA analyzer interface cable to the <host device>.
- 3 Connect a nomoline family sampling line to the ISA analyzer input connector.

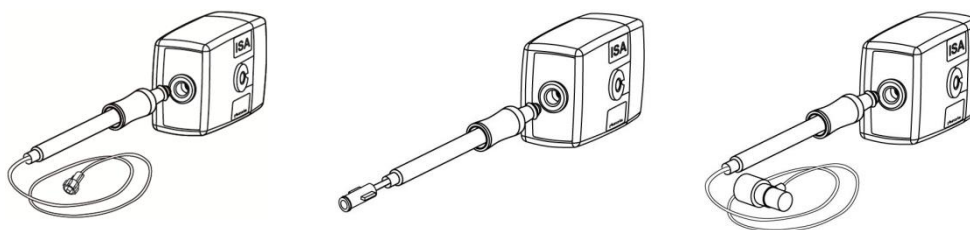

Figure 6.59

- 4 Connect the gas sample exhaust port to a scavenging system or return the gas to the animal circuit to prevent pollution of the operation room when N₂O and/or anesthetic agents are being used (refer to **section Pre-use Check**)
- 5 Power up the <host device>.
- 6 A green LED indicates that the ISA analyzer is ready for use.
- 7 Perform a pre-use check as described in section **Pre-use Check**.

◆ Pre-use Check

Before connecting the nomoline family sampling line to the breathing circuit, do the following:

- 1 Connect the sampling line to the ISA gas inlet connector (LEGI)
- 2 Check that the LEGI shows a steady green light, indicating that the system is OK.
- 3 For ISA OR+ and ISA AX+ module with O₂ option fitted:
Check that the O₂ reading on the monitor is correct (21%).
- 4 Breathe into the sampling line and check that valid CO₂ waveforms and values are displayed on the <host device>.
- 5 Occlude the sampling line with a fingertip and wait for 10 seconds.
- 6 Check that an occlusion alarm is displayed and that the LEGI shows a flashing red light.
- 7 If applicable:
Perform a tightness check of the animal circuit with the sampling line attached.

◆ **Leakage Check**

- 1 Connect a new nomoline sampling line with male luer lock to the ISA LEGI and check that the LEGI shows a steady green light.
- 2 Connect a short silicon tubing with an inner diameter of 3/32” (2.4 mm) to the nomoline male luer.
- 3 Exhale a long breath into the silicon tubing until the CO₂ concentration is greater than 4.5 vol% or 34 mmHg.
- 4 Quickly connect the silicon tubing tightly to the exhaust port.
- 5 Wait 1 minute until the CO₂ concentration has stabilized. Note the value.
- 6 Wait 1 minute and check that the CO₂ concentration has not decreased more than 0.4 vol% or 3 mmHg. If it has decreased more there is a major leakage in the ISA unit or in the nomoline. Do not operate the ISA if there is a major leakage in the unit.

◆ **Consumables**

For ordering information related to consumables delivered by PHASEIN, refer to section A.2 Accessories AG sidestream (Phasein).



Attention

- Using sample tubes or cannulas with larger inner diameter than 1 mm will increase ISA's total system response time.

Replacement of Nomoline and Nomoline Airway Adapter Set

The nomoline and nomoline airway adapter set are single-animal use products.

They should be replaced according to good clinical practice or when an occlusion message appears. Occlusion occurs when the sample flow is too low. This is indicated by a flashing red LEGI together with a message on the medical backboard device.

Replacement of Nomoline Adapter

The nomoline adapter is a multiple-animal use product.

The nomoline adapter should be replaced according to good clinical practice or when an occlusion message appears. Occlusion occurs when the sample flow is too low. This is indicated by a flashing red LEGI together with a message on the medical backboard device.

Replacement of T-adapter and Nomo Extension

The T-adapter and Nomo Extension are single-animal use products.

They should be replaced according to good clinical practice or when an occlusion message appears. Occlusion occurs when the sample flow is too low. This is indicated by a flashing red LEGI together with a message on the medical backboard device.

◆ Maintenance

Once every year, or whenever gas readings are questionable, perform a leakage check according to section Leakage check and verify gas readings with a reference instrument or with calibration gas. Calibration gas can be ordered from PHASEIN AB (www.phasein.com).

◆ Zeroing

The infrared gas analyzer needs to establish a zero reference level for the CO₂, N₂O and anesthetic agent gas measurement. This zero calibration is here referred to as “zeroing”.

ISA sidestream gas analyzers perform zeroing automatically by switching the gas sampling from the respiratory circuit to ambient air. The automatic zeroing is performed every 24 hours and takes less than 3 seconds for ISA CO₂ gas analyzers. For ISA multigas analyzers the automatic zeroing is performed every 8 hours and takes less than 10 seconds. If the ISA sidestream gas analyzer is fitted with an oxygen sensor, the automatic zeroing will also include room air calibration of the oxygen sensor.



Warning

- Since a successful zeroing requires the presence of ambient air (21% O₂ and 0% CO₂), ensure that the ISA is placed in a well ventilated place. Avoid breathing near the ISA sidestream gas analyzer before or during the zeroing procedure.

◆ Alarms

Also include an overview of the status indicated by the LEGI:

Table 6.7 Alarms Status

Indication	Status
Steady green light	System OK
Blinking green light	Zeroing in progress
Steady blue light	Anesthetic agent present
Steady red light	Sensor error
Blinking red light	Check sampling line

◆ Analyzer Cleaning

The “plug-in and measure” ISA sidestream gas analyzers and nomoline adapter can be cleaned using a cloth moistened (not wet) with max 70% ethanol or isopropyl alcohol.

To prevent cleaning liquids and dust from entering the ISA gas analyzer through its LEGI connector, keep the nomoline family sampling line connected while cleaning the analyzer.



Warning

- Never sterilize or immerse the ISA sidestream gas analyzer in liquid.

◆ Warnings and Attentions



Warning

- The ISA sidestream gas analyzer is intended for use by authorized healthcare professionals only.
- Carefully route the sampling line to reduce the risk of animal entanglement or strangulation.
- Do not lift the ISA/<host device> by the sampling line as it could disconnect from the ISA/<host

device>, causing the ISA/<host device> to fall on the animal.

- Dispose nomoline family sampling lines in accordance with local regulations for biohazardous waste.
- Use only airway T-adapters with the sampling point in the center of the adapter.
- Do only use sample lines intended for anesthetic agents if N₂O and/or anesthetic agents are being used.
- Do not use T-adapter with animal < 10 kg, as this adds 7 ml dead space to the animal circuit.
- Do not use the ISA gas analyzer with metered-dose inhalers or nebulized medications as this may clog the bacteria filter.
- Since a successful zeroing requires the presence of ambient air (21% O₂ and 0% CO₂), ensure that the ISA is placed in a well ventilated place. Avoid breathing near the ISA sidestream gas analyzer before or during the zeroing procedure.
- Never sterilize or immerse the ISA sidestream gas analyzer in liquid.
- Measurements can be affected by mobile and portable RF communications equipment. Make sure that the ISA sidestream gas analyzer is used in the electromagnetic environment specified in this manual.
- ISA sidestream gas analyzer is intended only as an adjunct in animal assessment. It must be used in conjunction with other assessments of clinical signs and symptoms.
- Replace the sampling line if the sampling line input connector starts flashing red, or a “Sample line clogged” message is displayed on the host.
- No modification of this equipment is allowed without authorization of the manufacturer. If this equipment is modified, appropriate inspection and testing must be conducted to ensure continued safe operation.
- ISA sidestream gas analyzers are not designed for MRI environments.
- During MRI scanning, the <host device> must be placed outside the MRI suite.
- Use of high frequency electrosurgical equipment in the vicinity of the ISA/<host device> may produce interference and cause incorrect measurements.
- Do not apply negative pressure to remove condensed water from the nomoline family sampling line.
- Too strong positive or negative pressure in the animal circuit might affect the sample flow.
- Strong scavenging suction pressure might affect the sample flow.
- Exhaust gases should be returned to the animal circuit or to a scavenging system.
- Due to the risk of animal cross-infection, always use a bacteria filter on the exhaust port side if sampled gas is intended to be re-breathed.
- Do not place the ISA gas analyzer in any position that might cause it to fall on the animal.
- Do not re-use disposable single-animal use nomoline family sampling lines due to the risk of cross contamination.
- Do not sterilize or immerse nomoline family sampling lines in liquid.
- Do not operate the ISA sidestream gas analyzer if the enclosure is damaged.



Attention

-
- The ISA “plug-in and measure” analyzers should be securely mounted in order to avoid the risk of damage to the ISA.
 - Do not operate the ISA sidestream gas analyzer outside the specified operating environment.
 - (US Only) Caution: federal law restricts this device to sale by or on the order of a licensed healthcare practitioner.

6.10.6 AG Setup

AG Setup			
Apnea Delay	20 s	CO ₂ Scale	7.0
Operating Mode	Measure	AA Scale	9.0
Pump switch	Off	N ₂ O Scale	50.0
O ₂ Compen	0 %	O ₂ Scale	50.0
CO ₂ Wave Fill	Off	Sweep	6.25mm/s
Zero		Alarm Setup>>	
Change type of the displayed waveform.			

Figure 6.60 AG Setup

◆ Apnea Delay

Set the Apnea delay time; when the animal suffocation time exceeds the set value, the monitor will trigger an alarm.

◆ Setting Waveform

In AG settings menu:

■ Set up [CO₂ Wave Fill]:

[Off]: describe CO₂ waveform with lines.

[On]: the area below CO₂ waveform is displayed by filling.

■ Select [Sweep]: select the appropriate settings in the pop-up list; the waveform speed: 6.25 mm/s, 12.5 mm/s, 25 mm/s. The larger the value, the scanning speed is the faster, and the waveform is wider.

■ Adjust the waveform ruler (CO₂, AA ruler, N₂O ruler, O₂ ruler) and the waveform amplitude changes accordingly.

◆ Operating Mode

For detailed, please refer to the content of 6.8.4 CO₂ Setup- Operate Mode.

◆ O₂ Compen



Warning

- Please set O₂ compensation to meet different actual conditions, otherwise, the measured results may deviated greatly and result in misdiagnosis.

6.10.7 Replacing Anesthetic

If the anesthetic used on the animal changes, the mixing of the two gases can be detected by the module during the transition period. However, the time required for anesthetic exchange depends on the type of anesthesia (low flow or high flow) and the properties of anesthesia. The anesthesia module can automatically identify the two anesthetics. When there is a greater change between the primary and secondary anesthetic gas components, the monitor will determine the dominant anesthetic according to the contribution to MAC value, thereby replacing the mark and data of displayed dominant anesthetic.

6.10.8 Measurement Influencing Factors

- Leak or internal leakage of sampling gas.
- Mechanical shock.
- Abnormal changes in cycle pressure and airway higher than 10 kPa (75 mmHg, 100 cmH₂O).
- Other sources of interference.

6.10.9 Emissions

Use an exhaust pipe and the vent on the module connected to the sample gas emissions to the waste processing system.



Warning

- Anesthetic: to measure the use of anesthetics or recently used anesthetic animals, the vent on the module must be connected to the exhaust gas treatment system, anesthesia machine or ventilator, to avoid medical personnel inhalation anesthetic.

Chapter 7 Alarm

7.1 General Description

Alarm means acoustic and optical prompts provided to the medical staff by the monitor in response to the changes in the vital signs of the animal that is being monitored or to problems with the monitoring of the animal following a mechanical breakdown of the monitor. Bedside alarm prompts are given for equipment that is not connected to the central station. For equipment that is connected to the central station, the alarm can be given at the central station.

7.2 Alarm Type

Alarm includes physiological alarm and technical alarm.

Physiological alarm: the alarm that is triggered when some physiological parameter of the animal is passed; for example, when the animal's heart rate is above the limit.

Technical alarm: the alarm that is triggered when one or more monitoring functions are abnormal or the measured results are distorted following the failure of the system or sensors; for example, ECG animal cable fall off.

7.3 Alarm Level

Alarm has three levels: High, Mid and Low.

The monitor has preset alarm levels for both physiological and technical alarms.



Attention

- Only the Mid and Low alarm levels are available for arrhythmia analysis except Asystole and VFib/VTac (ventricular fibrillation/ventricular tachycardia).

7.4 Alarm Mode

◆ Lighting Alarm

Please refer to 2.3.1 for more details.

◆ Audible Alarm

Please refer to 7.6.10 for more details.

◆ Parameter Flashing

When a physiological parameter of the animal is alarmed, the parameter in parameter region flashes once per second and the upper or lower limit of the parameter also flashes with the same frequency indicating that the parameter is running beyond its upper limit or below its lower limit.

◆ Text Message

Corresponding text messages are also offered by the monitor's physiological and technical alarm regions when an alarm is in process. For physiological alarms, the symbol '*' is added in the front of the alarm message to discriminate its level: '***' represents a high-level alarm, '**' represents a mid-level alarm, and '*' represents a low-level alarm. But for technical alarms, no symbol '*' is added in the front of the alarm messages in the technical alarm display region.

Furthermore, the monitor also uses different background colors to discriminate different alarm levels. Red represents a high-level alarm, yellow represents a mid-level alarm and low-level physiological alarm, and blue represents a low-level technical alarm.

◆ **Alarm Reminder Tone**

The monitor provides the function of monophonic alarm prompts which remind users that the system currently has an active alarm in case alarm silence is activated or the [Alarm Volume] is 0.

 **Explanation**

 Alarm Silencing

 Alarm Pausing

 Alarm Sound Off

 Some Parameters Alarm Off

 Attention

- The monitor will provide alarms of the highest level in both lighting and sound when different levels of alarms are triggered at the same time.

7.5 Alarm Setup

Press the Alarm Setup shortcut key, or select the [Main Menu] to enter the Alarm Setup window, as shown in Figure 7.1:

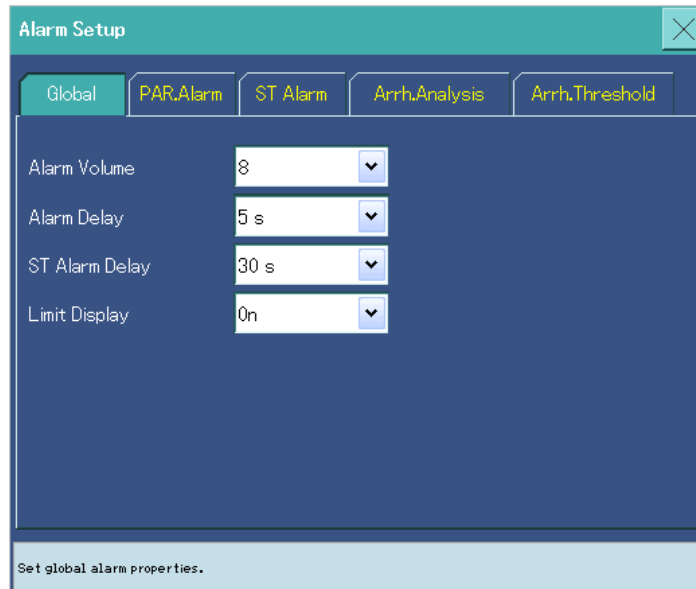

Figure 7.1 Alarm Setup Menu

This window includes: 1. Global Alarm 2. Parameter Alarm 3. ST Alarm 4. Arrhythmia Analysis and 5. Arrhythmia Threshold.

For the ST Alarm Setup, please refer to Section 6.1 on ECG for the Arrhythmia Analysis Setup and Arrhythmia Parameter Threshold Setup.

7.5.1 Global Alarm Interface

◆ Alarm Volume Setup

Select [Main Menu]-[Alarm Setup] or directly click the shortcut key [Alarm Setup] on the screen:

Select [Global Alarm]-[Alarm Volume]: x-10, x being the minimum value on the setting of the lowest alarm volume. 0 means volume off and 10 means the maximum volume.

◆ Alarm Delay Setup

Alarm delay time can be set for overrunning alarms of continuous measure parameters. The monitor won't warn when the triggering conditions are not existent or disappear within the preset delay time.

Select [Main Menu]-[Alarm Setup] or directly click the shortcut key [Alarm Setup] on the screen:

Select [Global]-[Alarm Delay]: Off, 1s, 2s, 3s, 4s, 5s, 6s, 7s and 8s.

◆ ST Alarm Delay Setup

Select [Main Menu]-[Alarm Setup] or directly click the shortcut key [Alarm Setup] on the screen:

Select [Global]-[ST Alarm Delay]: Off, 30s, 45s, 60s, 75s, 90s, 105s, 120s, 135s, 150s, 165s and 180s.

◆ Alarm Limit Display Setup

Select [Main Menu]-[Alarm Setup] or directly click the shortcut key [Alarm Setup] on the screen:

Select [Global], select [Limit Display]: On or Off. When On is selected, the upper and lower limits of the parameter are displayed on the main screen Parameter Region, when Off is selected, the upper and lower limits are not displayed in the Parameter Region.



Attention

- When the animal category is < 10kg, the setting of ST Alarm Delay is not available, for ST analysis is not applicable to animals < 10 kg.

7.5.2 Parameter Alarm Setup

Select [Main Menu]-[Alarm Setup]-[PAR.Alarm], and users can view and revise the warning On/Off state, warning upper and lower limits, warning levels and alarm record On/Off state of all parameters in the current measure.

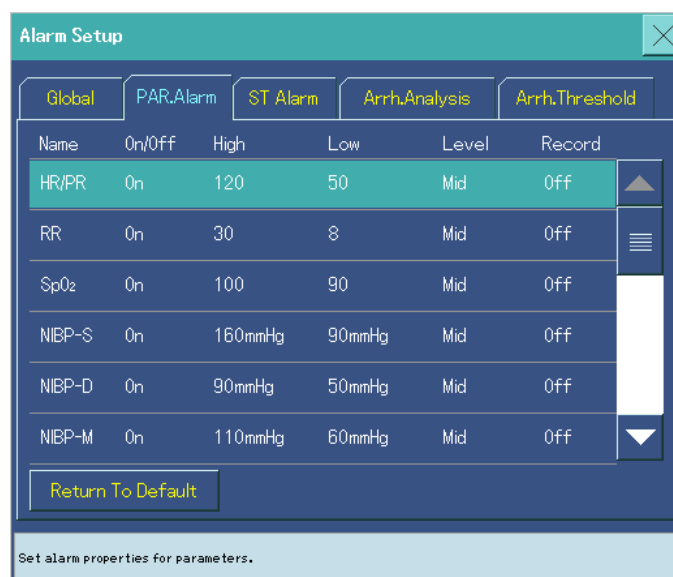

Figure 7.2 Parameter Alarm



Attention

- This alarm triggers the recorder to output the waveforms of this alarm and values of all parameters only when both the alarm switch and the alarm records of a parameter are set [On].



Warning

- Before starting the monitor, users are required to check whether the setting of the alarm limits are suitable for the animal.
- Don't set an alarm value that exceeds its limit, otherwise the system will fail.

7.6 Alarm Configuration

Select [Main Menu]-[Maintenance]-[User Maintain>>], input user maintain password, select [Alarm Config>>].



Figure 7.3 Alarm Configuration

- ◆ **Alarm Pause Time Setup**
Enter [Alarm Config>>] and select [Pause Time]: 60s, 120s and 180s.
- ◆ **Alarm Mode Setup**
Enter [Alarm Config>>] and select [Alarm Mode]: Unlatch and Latch:
Latch alarm: alarm lasts until animal processing is done;
Unlatch alarm: alarm ends and terminated by the system.
- ◆ **Silence Other Bed Setup**
Enter [Alarm Config>>] and select [Silence Other Bed]: Off or On.
- ◆ **Parameter Flash Setup**
Enter [Alarm Config>>] and select [PAR.Flash]: Off or On. Parameter is flashing when alarm exist.
- ◆ **Full Prohibition Setup**
Enter [Alarm Config>>] and select [Full Prohibition]: On or Off. Prohibition period of high level arrhythmia alarm default must be manually eliminated in the alarm line, but you can press [Alarm Mute] to end the prohibition period of High level arrhythmia alarm. The full prohibition in [Alarm Config>>] is defaulted on, When it is set as off, prohibition period ends automatically if it detects ECG signal.

◆ Alarm Forbidden Time Setup

Enter [Alarm Config>>] and select [1st Forbid Time] and [2nd Forbid Time].

[1st Forbid time]: Off, 1min, 2min, 3min, 4min and 5min.

[2nd Forbid time]: Off, 1min, 2min, 3min, 4min, 5min, 10min and 15min.

◆ Fatal Arrhythmia Setup

Enter [Alarm Config>>] and select [Fatal Arrh.Off]: Enable or Disable. It allows user to reset the fatal arrhythmia analysis in the alarm setup menu.

◆ Minimum Alarm Volume Setup

Enter [Alarm Config>>] and select [MIN Alarm Volume]: 0, 1 and 2.



Warning

- The lowest alarm volume determines the minimum value for the alarm volume setup, thus it requires caution by users.

◆ Alarm Reminder Tone Setup

Enter [Alarm Config>>] and set the alarm tones as follows:

- Select [Reminder Tone]: Off or On.
- Select [Reminder Volume]: 1~10.
- Select [Reminder Interval]: 1min, 2min and 3min.

◆ Alarm Sound Setup

Enter [Alarm Config>>] and select [Alarm Sound]: ISO, Mode 1 and Mode 2. The ISO mode is self-definable, when Mode 1 or Mode 2 is selected, the Alarm Sound Interval is defaulted, and cannot be reset.

◆ ISO Mode

- High-level alarm sound interval: 0s, 1s, 5s, 10s and 20s
- Mid-level alarm sound interval: 0s, 1s, 5s, 10s and 20s
- Low-level alarm sound interval: 0s, 1s, 5s, 10s and 20s

◆ Mode 1 (System Default)

- High-level alarm sound interval: 0s
- Mid-level alarm sound interval: 5s
- Low-level alarm sound interval: 20s

◆ Mode 2 (System Default)

- High-level alarm sound interval: 1s
- Mid-level alarm sound interval: 5s
- Low-level alarm sound interval: 20s



Attention

- In the ISO mode, the sound interval for the low-level alarm must be bigger than or equal to that of the mid-level alarm and the sound interval for the mid-level alarm must be bigger than or equal to that of the high-level alarm.

7.7 Alarm Setup

7.7.1 Alarm Setup Interface

Press the Alarm Setup shortcut key, or select the [Main Menu] to enter the Alarm Setup window, as shown in Figure 7.3:

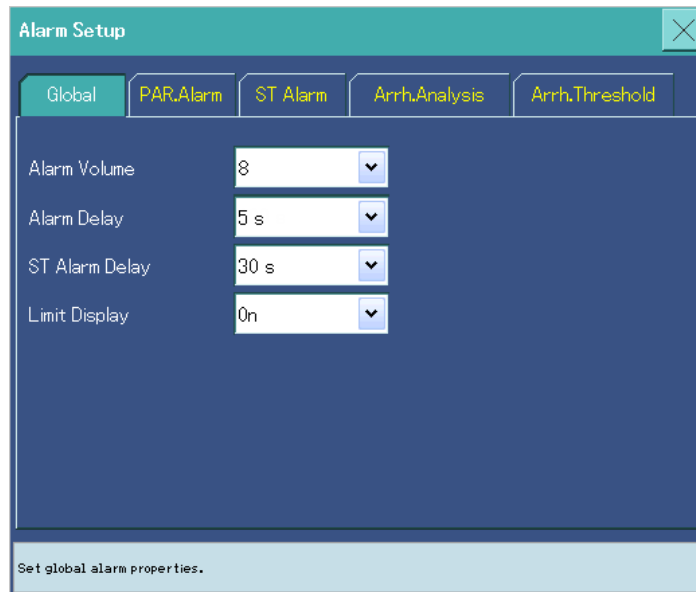

Figure 7.3 Alarm Setup Menu

This window includes: 1. Global Alarm 2. Parameter Alarm 3. ST Alarm 4. Arrhythmia Analysis and 5. Arrhythmia Threshold.

Please refer to Section 7.5 for the Global Alarm Setup. For the ST Alarm Setup, please refer to Section 6.1 on ECG for the Arrhythmia Analysis Setup and Arrhythmia Parameter Threshold Setup.

7.7.2 Parameter Alarm Setup

Select [Main Menu] - [Alarm Setup] - [PAR.Alarm], and users can view and revise the warning On/Off state, warning upper and lower limits, warning levels and alarm record On/Off state of all parameters in the current measure.

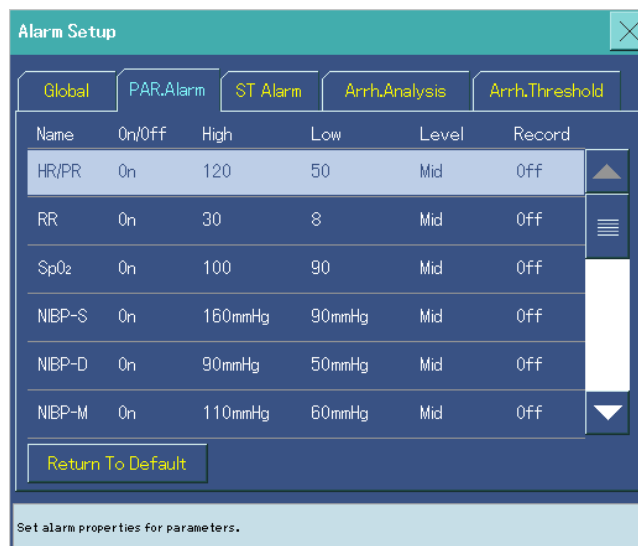

Figure 7.4 Parameter Alarm



Attention

- This alarm triggers the recorder to output the waveforms of this alarm and values of all parameters only when both the alarm switch and the alarm records of a parameter are set [On].



Warning

- Before starting the monitor, users are required to check whether the setting of the alarm limits are suitable for the animal.
- Don't set an alarm value that exceeds its limit, otherwise the system will fail.

7.8 Alarm Pause

Press the button [PAUSE] on the control panel, then all audible alarms can be stopped, the lighting and parameter higher/lower limits of the alarm parameter stop flashing, alarm text messages are not displayed, and the display of the remaining time of the Alarm Pause is displayed in the physiology alarm region and the alarm state symbol is also displayed.

The monitor directly enters the alarm pause state when it starts, and the pause time can be set in [User Maintain] - [Alarm Config].

The monitor automatically cancels the alarm pause when the alarm pause time has elapsed. When the monitor is in the 'Alarm Pause' state, you can press the button [PAUSE] to manually cancel the alarm pause.



Attention

- Users intentionally disconnecting sensors, probes or a module can press the button [PAUSE] to make the system enter the 'Alarm Pause' state.

7.9 Alarm Silence

Press the button [SILENCE] on the control panel, then all alarms of the monitor currently in process can be silenced: the audible alarm and the lighting is cleared while the alarm state symbol  is displayed.

When a physiological alarm is silenced, a '√' is added in the front of the text message, indicating that the alarm is silenced, but it is displayed on normal background color and the parameter of the alarm and its upper/lower limits still keep flashing.

When a technical alarm is silenced, no '√' is added in the front of the text message and it is displayed with the background color disappearing.

Under the Alarm Silence state, the text alarm message of a silenced alarm is also cleared when it is no longer exists.



Attention

- When the system is in the 'Alarm Silence' state, any newly triggered alarms will release the 'Alarm Silence' state, but only the new one has normal audible and lighting alarms, leaving the silenced alarm still being silenced.
- Disconnect the probe module technology caused alarm cannot be turned off, the alarm will always exist until the probe is re-connected, the module reload successfully, and then alarm disappears.

7.10 Alarm Detection and Counter Measures

The monitor will perform alarm self-check when it starts. At that moment, the technical alarm lights and blue and yellow alarm lights are turned on simultaneously and are turned off simultaneously when the system has a ‘thudding’ sound. This means that the audible, lighting alarm indicators work normally.

When the monitor gives alarms:

1. Check the animal’s actual clinical condition.
2. Confirm the type and parameter of the current alarm.
3. Recognize the alarm cause.
4. Deal with the alarm cause.
5. Check whether the alarm disappears.

Please refer to the **Alarm Information** listed in **Appendix C** for detailed counter-measures of each alarm.

7.11 Other Bed Alarm

7.11.1 Other Bed Alarm Auto Prompting

Set the function of automatic prompting for other-bed alarms:

- 1 Select the shortcut key [Screen] on the main screen-[Screen Config] - [Interface Type] - [View Other Bed].
- 2 Select the button [Setup] in the View Other Bed window and set the [Auto Alarm]-[On] in the pop-up menu.

In case the other bed alarm automatic prompting function is set to On, the monitor also provides prompting information in the Prompting Message Region as shown in Figure 7.4 when another-bed monitor alarms but its observation interface is not started in another-bed cluster established by the monitor.

There's alarm of other bed.

Figure 7.4 Other Bed Alarm Prompting Information

7.11.2 Other Bed Alarm Silence

You can perform remote alarm silence control for the currently observed other-bed monitor in the other-bed observation interface.

In case the other-bed mute function is set [On], click the button [SILENCE] in the other bed observation interface and then the current alarms of the currently observed other-bed monitor can be silenced when it alarms.



Attention

- This button is invalid when other bed monitor is in a state of alarm shutdown or alarm pause.
- This function can only be set in menu [User Maintain>>] - [Alarm Config>>].



Warning

- The remote alarm silence control of other bed monitors has potential risks, please handle it cautiously.

Chapter 8 Freeze and Review

8.1 Enter Freeze

1. Press the  button on the panel in non-freeze state. System will display the freeze menu.





Figure 8.1 Freeze Menu

2. All waveforms are frozen, and waveforms are no longer refreshed or scrolling. Data in the parameter zone refresh normally.



Attention

- Freeze state does not influence OxyCRG, Minitrends, View Other Bed window, and the rhythm lead display.

3. You can click on the [Review] button in the freeze state, then select  or  in the submenu that has appeared.

The frozen waveform will move left or right. Meanwhile, there will appear an ↗ on the lower right corner of the bottom waveform. At the bottom of the arrow is a time scale, where the freeze moment is marked [0s]. As waveform moves right, the time scale will turn to -1s, -2s, -3s... in order. The time scale applies to all waveforms on the screen. It can be viewed for at most 2 minutes, and will not be stored when power is turned off.



Figure 8.2 Freeze Menu Review

8.2 Remove Freeze

In freeze state, the following operations can be done to remove freeze state:

- Push the  button on the monitor panel again.
- Execute any operation that will lead to screen adjustment or menu display, e.g.: insert and remove modules, push the main menu button etc.

8.3 Record Frozen Waveforms

1. In the freeze menu that has appeared, select [Curve 1], [Curve 2] and [Curve 3].
2. In the freeze menu, select [Record] button. The recorder will output the selected waveform and the freeze moment parameter value.

8.4 Review

8.4.1 Review Window

Select [Main Menu] - [Review] or directly select physiological alarm display zone, as Figure 8.3 shows:

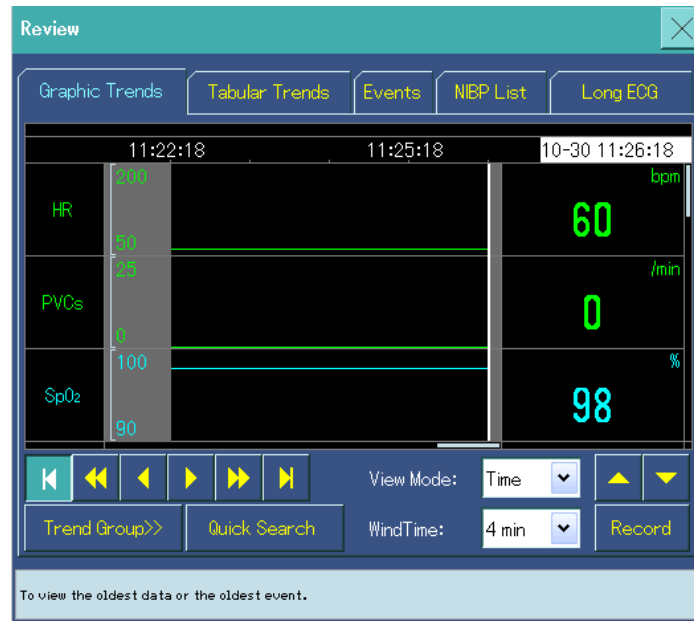

Figure 8.3 Review Window

User can select [Graphic Trends], [Tabular Trends], [Events], [NIBP List] or [Long ECG] to open the corresponding window.

8.4.2 Graphic Trends

Select [Review] - [Graphic Trends], open the window as Figure8.4 shows:

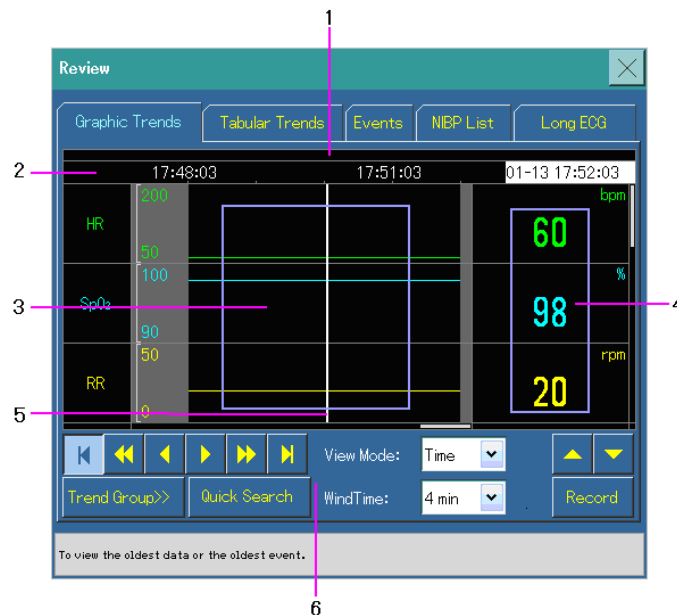

Figure8.4 Graphic Trends Window

- 1. Event bar 2.Timer bar 3. Graphic Trends zone
- 4. Trend data zone 5.Cursor 6.Tool operating bar

High-level alarm event will be respectively marked on the event bar display in red, Mid-level and Low-level alarm event is yellow, and the manual event is green.

◆ **View Mode**

Select Time or Event to view graphic trends window.

◆ **Window Time**







Select [WindTime], you can set the duration of time for the review window. When system sets the window



time as 4min, 40min, 2h, and data can be reviewed for at most 72 hours; As with 4h, 8h, 16h, 32h, 48h, data can be reviewed for at most 480 hours. Graphic trends review has power-down and store function.

◆ Set Trend Group

Select [Trend Group >>], in the menu that has popped up. Select the parameter group that needs viewing. User can also select [User-defined 1], [User-defined 2]. If you select [Define Group>>>] button at the bottom of the screen after having selected [User-defined 1] or [User-defined 2], you can select the trend parameter that needs viewing in the menu that has popped up.

◆ Browse

Select  or  button to move the trend cursor forward or backward. Select  or , turn pages forward or backward to move the waveforms; Select  or  to view the first data, the first event entry or view the last data, the last event. Time above the trend data zone displays the time corresponding to the current cursor, and the trend data zone displays the parameter data at that moment. They will change as the trend cursor moves.

Select  or  to browse last page's parameters or next page to display more parameter values.

◆ Quick Search

Select [Quick Search], and you can find Veterinary Monitoring Graphic trends information in the period of time.

◆ Record

Select [Record], and you can record the graphic trends that the current window is displaying.

8.4.3 Tabular Trends

Select [Tabular Trends] in the Review menu. Open the window as figure8.5 shows:

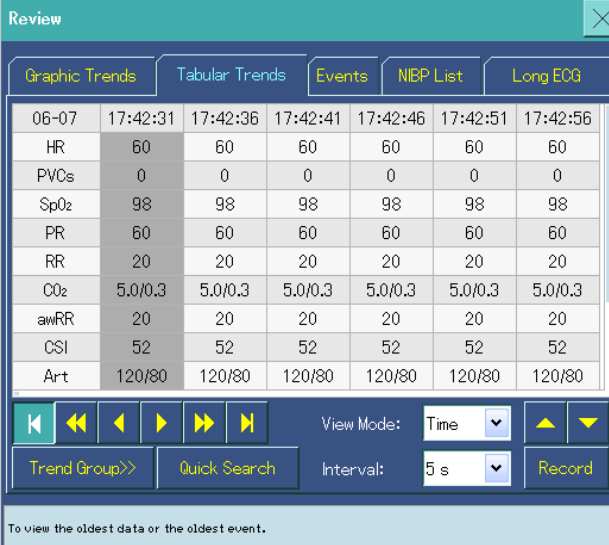

06-07	17:42:31	17:42:36	17:42:41	17:42:46	17:42:51	17:42:56
HR	60	60	60	60	60	60
PVCs	0	0	0	0	0	0
SpO ₂	98	98	98	98	98	98
PR	60	60	60	60	60	60
RR	20	20	20	20	20	20
CO ₂	5.0/0.3	5.0/0.3	5.0/0.3	5.0/0.3	5.0/0.3	5.0/0.3
awRR	20	20	20	20	20	20
CSI	52	52	52	52	52	52
Art	120/80	120/80	120/80	120/80	120/80	120/80

Figure 8.5 Tabular Trends Window

◆ Interval



When the interval is selected as 5 s, 30 s, 1 min, 10 min, you can observe the trend variations in the last 72 hours; and when the interval is selected as 15 min, 30 min, 1 h, 2 h, 3 h, you can observe the trend variations in the last 480 hours. The tabular trends review has power-down store function.



◆ View mode

Select Time or Event to view the trend chart window.

◆ Browse

Select  or  button to move the tabular trends cursor forward or backward. Select  or , to move the

tabular trends data forward or backward; Select  or  to view the first data, the first event entry or view the last data, the last event.

Select  or  to turn backward or forward to view more parameter values.

◆ **Set Trend Group**

Figure 8.4.2 Set Trend Group.

◆ **Quick Search**

Select [Quick Search], and you can find Veterinary Monitoring Tabular Trends information in the period of time.

◆ **Record**

Select [Record] and you can record the tabular trends data that is displayed in the current window.

8.4.4 Events

Select [Events] in the Review menu, and open the window as Figure 8.6 shows:

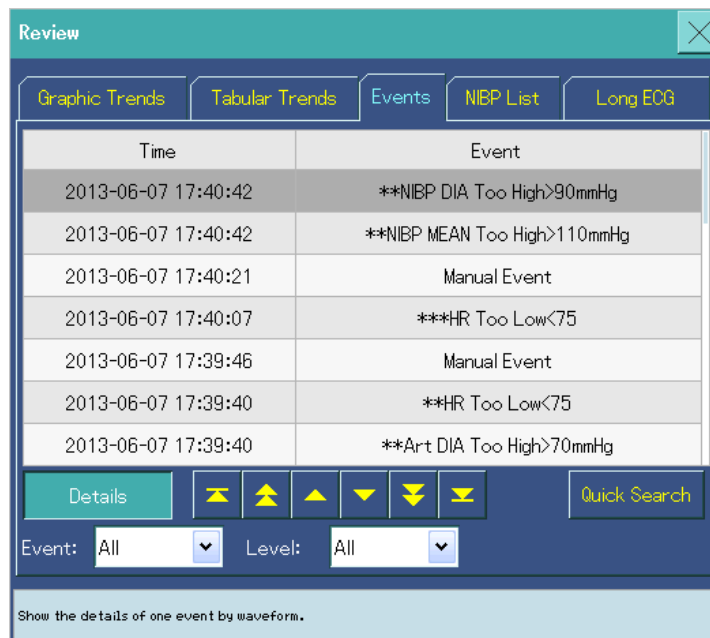

Figure 8.6 Events Window

Event that users can review are: manual event, arrhythmia event and parameter alarm event. When an event occur, monitor will store the time the event occurs, relative parameter values, and relative waveform data 5 secs before or after the event occurs, so that user can proceed with event review. You can review at most the last 700 events with event review. Moreover, event review also has power-down and store function.







◆ **Event Type**

Select [Event], and select the event type that needs review in the type list that has popped up.

◆ **Level**

Select [Level], and select the event level that needs review in the level list that has popped up: All, High, Mid, and Low. When event type is selected as manual event, the event level is defaulted as [All].

◆ **Browse**

Select  or  button to move the event data up and down. Select  or  button to turn pages up or down to move the event data. Select  or  to select the page where the most recent event data is located or the page with the first measured event data are located.

◆ **Quick Search**

Select [Quick Search], and you can find Veterinary Monitoring Events information in the period of time.

◆ **Details Information**

In the Events window, after selecting one certain event, select [Details], open the window as figure8.7 shows:

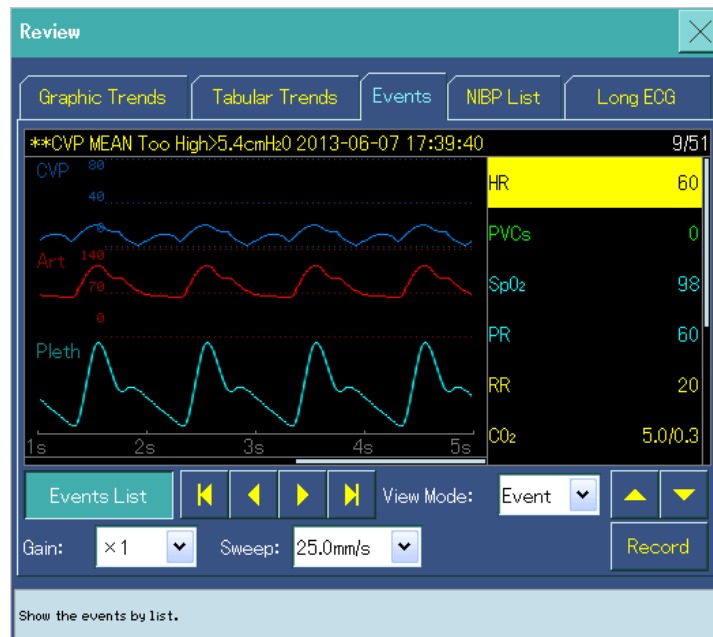

Figure 8.7 Event Details Information Window

The window waveform zone displays event related waveforms, and parameter zone displays related parameter values.

◆ **Events List**

Display events in list mode.

◆ **View Mode**

■ **Event**

Select or to browse the last event or the next event, push or to browse the event that occurred first or occurred last.

■ **Time**

Select or to browse the waveform 1 sec before or after a certain event, push or to browse the waveform 5 secs before or after a certain event.

◆ **Gain**

Select $\times 1/8$, $\times 1/4$, $\times 1/2$, $\times 1$, $\times 2$, $\times 4$ to change the gain of the ECG waveform.

◆ **Sweep**

Select 6.25 mm/s, 12.5 mm/s, 25.0 mm/s, 50.0 mm/s, to change the speed of all 3 waveforms that is currently being displayed.

◆ **Record**

Record current alarm event.

8.4.5 NIBP List

Select [NIBP List] in the Review menu, open the window as figure8.8 shows:

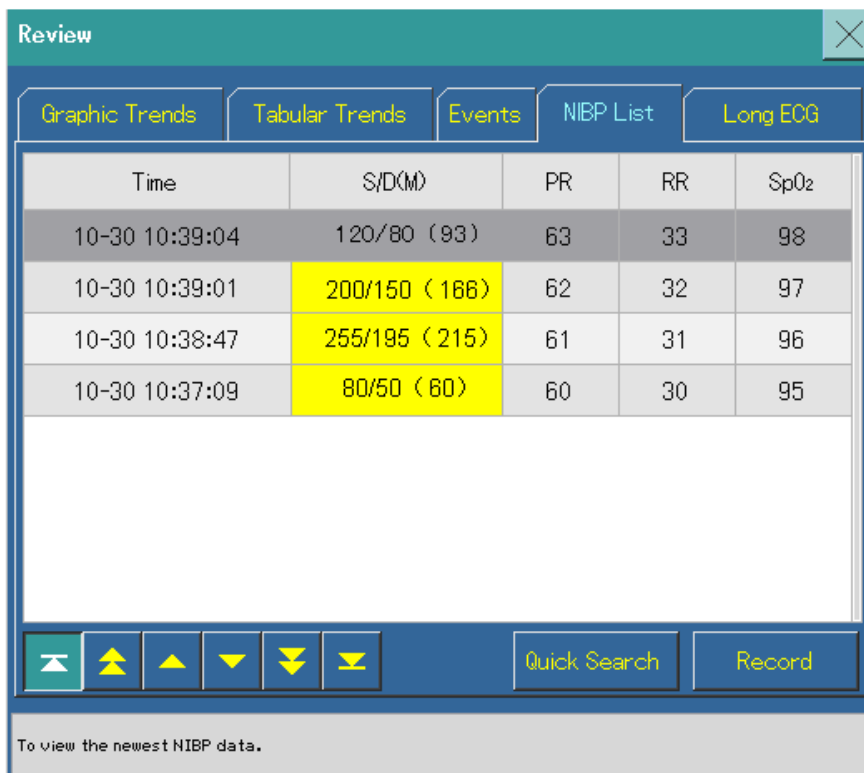

Figure 8.8 NIBP List Window

◆ **Browse**

Select or button to move the list data up and down; select or button to turn pages up or down to move the list data; select or to select the page where the most recent NIBP data are located or the page with the first measured NIBP data is located. NIBP list review supports at most display of 1000 groups of NIBP data. Moreover, NIBP list review has power-down and store function.

◆ **Record**

Record NIBP data displayed in the record list.

◆ **Quick Search**

Select [Quick Search], and you can find Veterinary Monitoring Events information in the period of time.

8.4.6 Long ECG

Select [Long ECG] in the Review menu, open the window as figure8.9 shows:

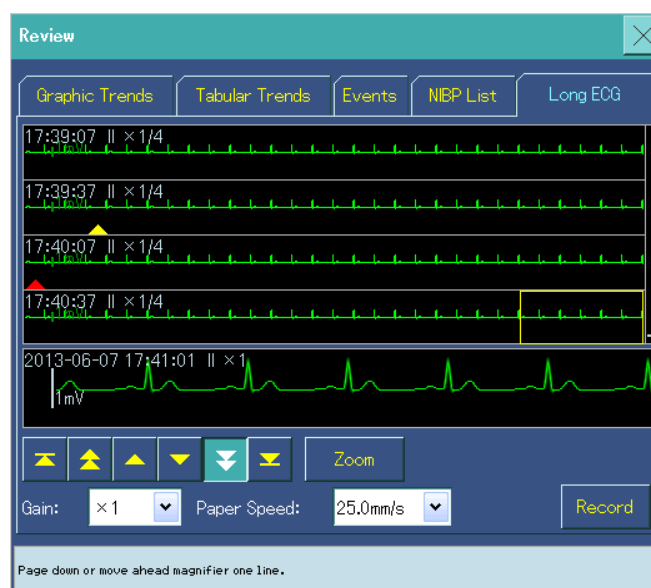







Figure 8.9 Long ECG

To choose the lead that stores the waveform data is set in [ECG Setup]- [Others>>]- [Save Curve]. Long ECG can browse the last 2 hours' waveform data. Long ECG also has power-down and store function.







In the Long ECG window, what is displayed on the first 4 lines is the waveform whose stored lead gain is x1/4. When the ECG module occurs physiological alarm, in the event of alarm time zones will display and alarm level corresponding to the alarm tag. The 5th line is the magnified display zone for waveforms, displaying the waveform in the selected area of the magnifying box which has been magnified by the multiplier set in [Gain].

◆ Browse

- **When the magnifying zoom is not locked, and the magnifying zoom button appears as **

You can browse 2 hours' waveform data with browse button. Select  or  to turn back or forward 1 line to view the ECG waveform; select  or  to turn pages forward or backward to view ECG waveform; select  or  to view the first or the last ECG waveform.

- **To lock the magnifying zoom, push magnifying zoom button, when it displays **

You can browse waveform data on the current page by using the browse button. Select  or  to move the magnifying zoom one step forward or backward; select  or  to move the magnifying zoom one line backward or forward; select  or  to move the magnifying zoom to the front or rear zone of the current page.

◆ Gain

Select $\times 1/8$, $\times 1/4$, $\times 1/2$, $\times 1$, $\times 2$ and $\times 4$ to change the gain of the magnified ECG store lead waveform.

◆ Paper Speed

Select 12.5 mm/s, 25.0 mm/s, 50.0 mm/s to change the drive speed when recording the waveform.

◆ Record

Record the waveform in the current magnifying zoom.

-- The Blank Page --

Chapter 9 Calculations

9.1 General Description

This series of monitors have calculating functions. The calculated values are not animal data that is directly measured, but is the results calculated by the monitor based on the data provided.



Attention

- Calculation is independent of the other functions of the monitor; calculated subject does NOT need to be the Veterinary Monitored by this series of monitors. The calculating operation will not have an influence on the animal that is being monitored.



Warning

- When calculating, you should verify carefully the correctness of the input parameters and the suitability of the calculating results. The company will not be responsible for any results that is caused by input and operation errors.



Explanation

- When using the soft keyboard to input parameters, if the input values are beyond the effective scope, "WARNING" appears and shows the effective input range.
- The printing content of animal information in calculation including name, Gender, No., Bed No., Height, Weight, Birthday are blank. The doctor can according to needs to fill in the corresponding information after printing.

9.2 Medication Calculation

Select [Main Menu] – [Animal Cat.] - [Dose], as figure 9.1 shows:

Parameter	Value	Unit
Animal Cat.	>20kg	
Drug Name	Drug A	
Weight	70.00	kg
Drug Qty	400.00	mg
Sol Volume	250.00	ml
Concentr.	1.60	mg/ml
Dose	2500.00	mcg/min
Dose	150.00	mg/h
Dose	35.71	mcg/kg/min
Dose	2142.86	mcg/kg/h
Inf Rate	93.75	ml/h
Drip Rate	31.25	gtt/min
Drop Size	20.00	gtt/ml
Inf Time	2.67	h

Figure 9.1 Dose

Medication dosage calculation use the following formulas:

$$\text{Concentration} = \text{Drug Quantity} / \text{Solusion Volume}$$

$$\text{Infusion Rate} = \text{Dose} / \text{Concentration}$$

$$\text{Infusion Time} = \text{Drug Quantity} / \text{Dose}$$

◆ **Calculation Procedure**

1. Select [Animal Cat.] and [Drug Name]. In the list of drug names, you can select 15 kinds of drug below: Drug A, Drug B, Drug C, Drug D, Drug E, Aminophylline, Dobutamin, Dopamine, Epinephrine, Heparin, Isuprel, Lidocaine, Nipride, Nitroglycerin and Pitocin. Of those, Drug A, Drug B, Drug C, Drug D, Drug E are defined by user.
2. After the operations above, system will automatically generate a group of default values, which are for reference only, user must input known, correct parameter values according to animal data.
3. Input animals' weight and correct parameter values.
4. Verify the correctness of the calculated results.

◆ **Calculation Unit**

Every kind of medication is calculated with fixed unit or unit dosages. In the same unit dosages, units' system will be automatically adjust to input parameter values.

The calculating units of each kind of medications are as follows:

- Drug A, Drug B, Drug C, Aminophylline, Dopamine, Dobutamin, Epinephrine, Isuprel, Lidocaine, Nipride, and Nitroglycerin with unit series: g(gram), mg(milligram), mcg(microgram).
- Drug D, Heparin, Pitocin, with unit series: Unit (one unit), kU (one thousand units), MU (one million units).
- Drug E use units: mEq (milligram equivalent).

When customizing certain kinds of drug, operator should select Drug A, Drug B, Drug C, Drug D or Drug E according to unit dosage.



Attention

- For animals < 10 kg, [Drip Rate] and [Drop Size] do not apply.

◆ **Titration Table**

After finishing medication calculation, select [Titration Table >>] in the Dose window, open titration table, as figure 9.2 shows:

Titration Table - >20kg - Drug A					
Weight	70.00	kg	Sol Volume	250.00	ml
Drug Qty	400.00	mg	Inf Rate	93.75	ml/h
Dose	150.00	mg/h	Drip Rate	31.25	gtt/min
Dose	Inf Rate	Dose	Inf Rate	Dose	Inf Rate
0.00	0.00	9.00	5.62	18.00	11.25
1.00	0.62	10.00	6.25	19.00	11.87
2.00	1.25	11.00	6.87	20.00	12.50
3.00	1.87	12.00	7.50	21.00	13.12
4.00	2.50	13.00	8.12	22.00	13.75
5.00	3.12	14.00	8.75	23.00	14.37
6.00	3.75	15.00	9.37	24.00	15.00
7.00	4.37	16.00	10.00	25.00	15.62
8.00	5.00	17.00	10.62	26.00	16.25
Reference	Dose	Interval	1	Dose Type	Dose/h
Shift		Record			

Figure 9.2 Titration Table

Reference: Dose, Infusion Rate, Drip Rate.

Interval: 1~10.

Dose Type: Dose/min, Dose/h, Dose/kg/minute, Dose/kg/h.

After entering the above options, data in the titration table will change accordingly.

Select [Shift] option, an arrow will appear  turning pages forward and backward, and you can observe more data by pushing left and right button.

Select [Record] and you can print the data being displayed in the current window with the recorder.

9.3 Hemodynamic Calculation

Select [Main Menu]- [Calculation]- [Hemodynamic Calculation], as figure 9.3 shows:

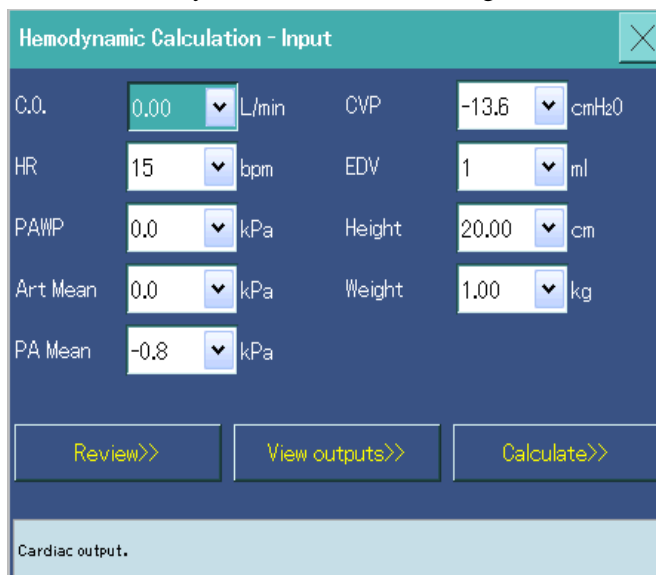
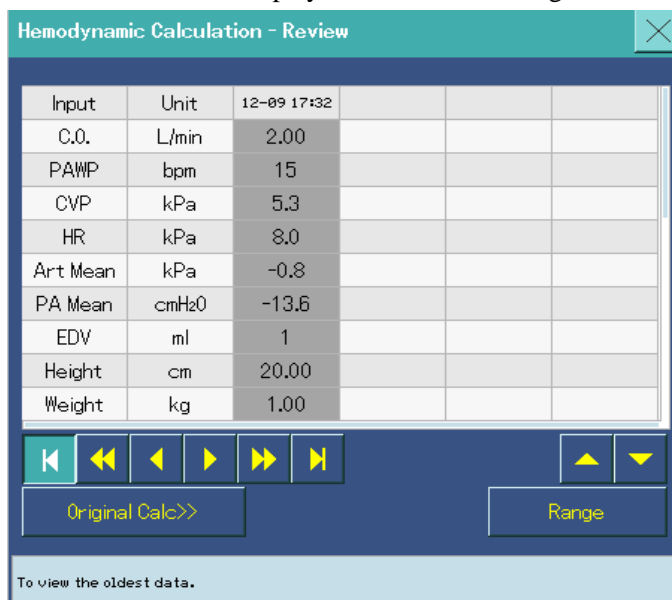

Figure 9.3 Hemodynamic Calculation

In Input interface, you can select [Review], [View outputs] and [Calculate].

9.3.1 Review

Select [Review], enter Review interface, which displays all the results, as figure 9.4 shows:





Input	Unit	12-09 17:32			
C.O.	L/min	2.00			
PAWP	bpm	15			
CVP	kPa	5.3			
HR	kPa	8.0			
Art Mean	kPa	-0.8			
PA Mean	cmH2O	-13.6			
EDV	ml	1			
Height	cm	20.00			
Weight	kg	1.00			



Figure 9.4 Review interface



In Review interface:



Select [Original Calculate], return to the forward interface.

Select [Range], display the reasonable scope of the output values.

Select  or  to view the forward or backward result.

Select  or  to view results of forward or backward page.

Select  or  to view the first or the last result.

Select  or  to scroll up or scroll down to view more parameter values.

9.3.2 Output

You can enter the Output interface by selecting [View outputs] or [Calculate] to view calculated outputs of the current input parameters. If by [View outputs], the outputs will not be saved, and you can only browse the output value. If by [Calculate], the current calculation results will be saved and can be viewed in Review interface.

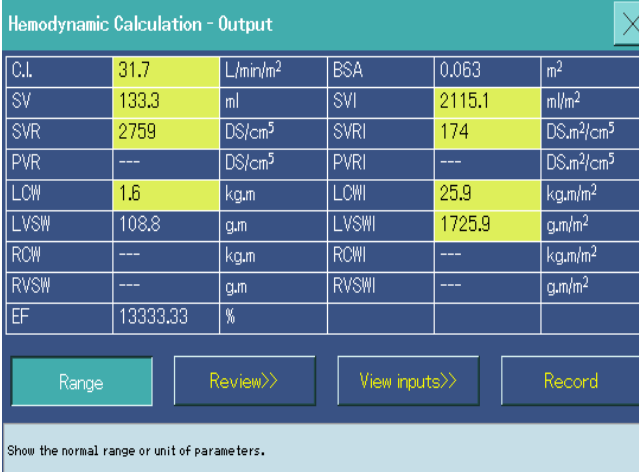

Hemodynamic Calculation - Output					
C.I.	31.7	L/min/m ²	BSA	0.063	m ²
SV	133.3	ml	SVI	2115.1	ml/m ²
SVR	2759	DS/cm ⁵	SVRI	174	DS.m ² /cm ⁵
PVR	---	DS/cm ⁵	PVRI	---	DS.m ² /cm ⁵
LOW	1.6	kg.m	LOWI	25.9	kg.m/m ²
LVSW	108.8	g.m	LVSWI	1725.9	g.m/m ²
ROW	---	kg.m	ROWI	---	kg.m/m ²
RVSW	---	g.m	RVSWI	---	g.m/m ²
EF	13333.33	%			

Range Review>> View inputs>> Record

Show the normal range or unit of parameters.

Figure 9.5 Output interface

Values which are beyond the normal range will be displayed on a yellow background. Please re-enter the reasonable value.

Select [Range], display the reasonable scope of the output values.

Select [Unit], display the unit of the output values.

Select [Review], enter Review interface.

Select [View inputs], enter Input interface.

Select [Record], print the current calculation. The printing content includes name, Gender, No., Bed No., Height, Weight, Birthday, Record Time and Hospital.

9.4 Renal Function Calculation, Oxygenation Calculation, Ventilation Calculation

Select [Main Menu] - [Calculation] - [Renal Function Calculation], [Oxygenation Calculation], or [Ventilation Calculation], enter the corresponding calculation interface and you can select [Calculate], [Range] and [Record].

Select [Calculate], the output area displays corresponding calculation results. Values which are beyond the normal range will be displayed on a yellow background. Please re-enter the reasonable value.

Select [Range], display the reasonable scope of the output values.

Select [Unit], display the unit of the output values.

Select [Record], print the current calculation. The printing content includes name, Gender, No., Bed No., Height, Weight, Birthday, Record Time and Hospital.

Chapter 10 Recording

10.1 Recorder

This monitor use a thermal array recorder, supports multiple recording types, including real-time recording, parameter crossed or alarm recording triggered by arrhythmia etc., and certain function-related recording.

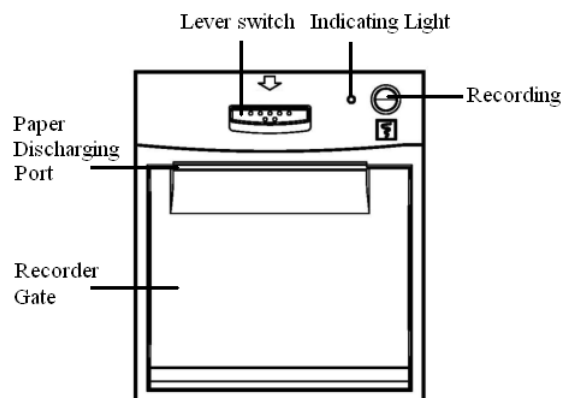

Figure10.1 Recorder

- ◆ **Recording**
Push this button and you can start or stop recording.
- ◆ **Lever Switch**
In accordance with the direction of the arrow press down, and you can open the recorder door.
- ◆ **Indicating Light**
 - On: recording apparatus is in the normal functioning state.
 - Off: recorder off.
 - Flashing: recorder failure, i.e.: no paper.

10.2 Record Setup

Select [Main Menu] - [Record Setup], as figure10.2 shows:

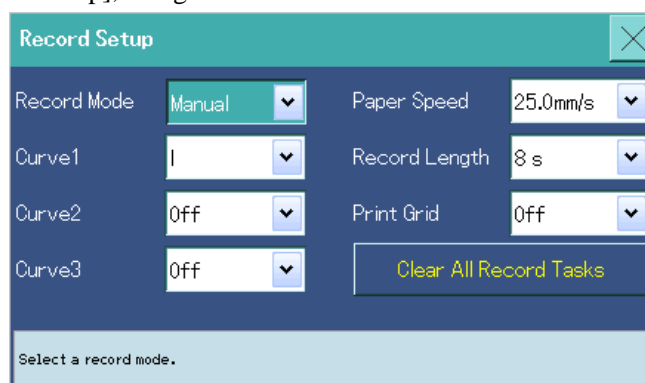

Figure 10.2 Record Setup

- ◆ **Record Mode Setup**
Set Record Mode: Manual, Continuous.
- ◆ **Curve Setup**
This series of monitors' recorder can print at most 3 curves. User can select curves in the list that has popped up. Switch to Off, and the curve will not be printed.
- ◆ **Paper Speed Setup**
Set Paper Speed: 12.5 mm/s, 25.0 mm/s, 50.0 mm/s. This setting applies to all record tasks that include

curve.

◆ **Record Length Setup**

When starting a recording, the duration of the recording depends on the setting chosen to the monitor's record length. In [Record Setup] menu, select [Record Length]:

- 8s: record the curve in next 8s.
- Continuous: record the curve after the current moment, till user stops the recording.



Attention

-
- The setting will not work when the record mode is in continuous record.

◆ **Print Grid Setup**

Select [Print Grid]: On or Off. Select on, the recorder will print the grid; select off, the recorder will not print the grid.



Attention

-
- If there is no grid on the thermal paper you are using, it is advised to use this option.

◆ **Clear All Record Tasks**

Select [Clear All Record Tasks] in [Record Setup] window, and it will eliminate all recordings that are to be printed, also stop the current record task.

10.3 Start and Stop Recording

User can select the modes below to start recording:

- Select [PRINT] button on the monitor panel or recording apparatus module, to start real time recording.
- Select [Record] button in the current window, and start certain function related recording.

Recorder automatic recording start:

- When the alarm switch of the parameters is set to on, and the alarm recording setting is also on. Once the parameter triggers an alarm, it will also trigger the monitor to start recording.

In the process of recording, you can use these modes to stop recording:

- Push [PRINT] button on the monitor panel or recording apparatus module.
- Select [Clear All Record Tasks] in [Record Setup] menu.
- Push [Record] button in the current window again.

In the following conditions, the recorder will automatically stop recording:

- Record task finished.
- Recorder is out of paper.
- Technical failure that stop the recorder from normal functioning.

10.4 Install Recording Paper

1. Push down the lever switch marked with an arrow (OPEN), to open the recorder door.
2. Put the recording papers into the paper discharging port, with paper edge set outside the exit, see Figure 10.3.

3. Close the recorder gate.
4. Check the location of the recording paper, to make sure the recording paper is lined up with the exit.

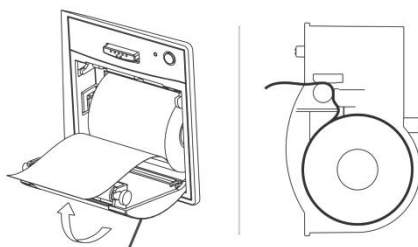

Figure 10.3 Install Recording Paper Diagram



Attention

- Recording paper should be pulled out in accordance with the slot limit of the exit, otherwise movement may occur in the recording process.
- Do not use thermo sensitive recording paper that does not meet standards.
- In the printing process of the recorder, do not pull the paper, as it could damage the recorder.
- Unless you are replacing the recording papers or trouble shooting don't open the recorder gate.
- When the sound of the recorder is abnormal or recording paper won't come out, check the recorder to see if the paper is stuck. If so, open the recorder door, get the recording paper out, eliminate the stuck part and reinstall recording paper.

10.5 Cleaning of the Thermal Print Head

After a long time using of the recorder, there will be scraps of paper and impurities on the print head, influencing the recording quality and the life of the print head and roller. So when using, user should clean the recorder regularly, to make sure the print head is clean.

After turning off, open the cartridge cover of the recording device and get out the recording paper, wipe the surface of the print head gently with a piece of clean cloth dipped in alcohol. For the material left on the recording head, you should soak it with alcohol, and then wipe it with a soft cloth. Never scratch the surface of the print head with a hard object, otherwise the print head will be damaged. Do not put on the cartridge cover back until the alcohol is completely dry.



Attention

- Before cleaning, take necessary measures to prevent damage that static electricity may cause to the recorder. Such as put on a pair of anti-static-electricity disposable bracelets.
- Don't use any objects that may damage the thermal parts, such as abrasive paper.
- Don't press hard on the thermal print head.
- When using normally, clean the print head at least once a month.

-- The Blank Page --

Chapter 11 Other Functions

11.1 Power-On

Press power switch button to power on/off the monitor. The monitor will do self-checking before entering main interface.

11.2 Colors of the Measured Physiological Parameters

Select [Main Menu] - [System] - [Screen Setup] or directly select [Screen Setup] shortcut key to enter [Screen Config] window.

Select [Para.Color>>], and you can set the colors of the waveforms and parameter displaying zone of ECG, NIBP, SpO₂, Resp, Temp, CO₂, IBP, N₂O, AA, O₂.

11.3 Analog Output Setup

This series of monitors have ‘analog output’ function by \ominus port. Connect the monitor with oscilloscope and other equipment, set related options, and then you can output simulated signals to other equipment through ports.

Select [Main Menu] - [System] - [Output Setup], as Figure 11.1 shows:

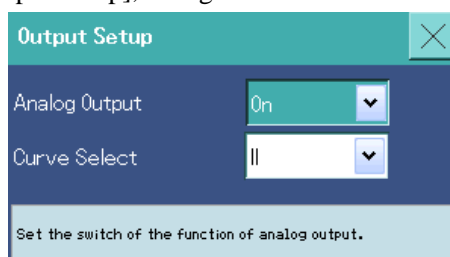

Figure 11.1 Output Setup

Select [Analog Output]: Off or On.

Select [Curve Select], select the curve you want to output.



Attention

- Analog output function in clinical rarely used. If you need more detailed information, please contact with repair.

11.4 Nurse Call System

This series of monitors have nurse calling ports. After connecting the monitor with nurse call system with the nurse call cables provided with the instrument, it will have ‘nurse call’ function. Nurse call function refers to when an alarm is triggered; the monitor will give signals to the nurse call system to call the nurses.

The nurse call function will only be functional when the following conditions are met:

1. The nurse call function is turned on.
2. An alarm that meets the user setting has been triggered.
3. The monitor is not in an alarm pause or an alarm mute state.

Select [Main Menu] - [System] - [Nurse Call Setup], as figure 11.2 shows:

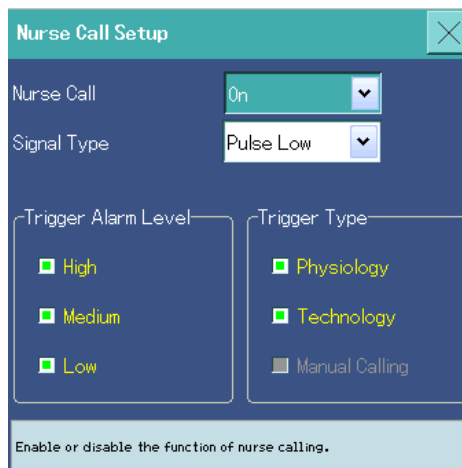

Figure 11.2 Nurse Call Setup

- ◆ **Nurse Call**
Set nurse call function: Off or On.
- ◆ **Signal Type**
Set the type of output signal that triggers nurse calling system: Pulse Low or Hold Low.
- ◆ **Trigger Alarm Level**
Set the alarm level that triggers nurse calling message: High, Mid, Low, you can choose multiple or none.
- ◆ **Trigger Type**
Set the alarm type that triggers nurse calling message: Physiology alarm or Technology alarm, you can choose multiple or none.

Attention

- If you select neither [Trigger Alarm Level] or [Trigger Type], then no alarm will trigger nurse calling signal.

Warning

- Nurse call function cannot serve as the main alarm message source. You should combine the audible and visual alarm of the equipment with animals' clinical manifestations and symptoms, to serve as the main alarm message source that notifies the doctors and nurses about an alarm state.

11.5 Defibrillation synchronization

When detecting R wave, the monitor will output a defib.Syn pulse signal. Defibrillator gets the defib.Syn signal from the monitor and should discharge accordingly during the declining period of R wave to reduce damage to the animal's heart.

Warning

- Improper use of a defibrillator may cause injury to the animal. The user should determine whether to perform defibrillation or not according to the animal's condition.
- Before defibrillation, the user must ensure both defibrillator and monitor has passed the system test and can be safely used jointly.
- Before defibrillation, make sure that [Defib. Sync] is set to [On] and the [Filter] is set to [Diagnostic].
- After defibrillation is finished, disconnect the defibrillator.

11.5 Manual Event

In the process of monitoring the animals, some incidences may influence the animal, causing variations of certain monitoring waveforms or parameters. To assist in analyzing these influences, user can manually mark certain event. In the review menu, manual event will display corresponding marks.

As figure 11.3 shows, select [Main Menu] - [System] - [Manual Event Setup] - select [Trigger Manual Event], and you can manually trigger a stored event.



Figure 11.3 Manual Event Setup

Attention

- If the three curves in [Curve Select] are off at the same time, it will not store any curve, but still can store measured data.

11.6 Defaults

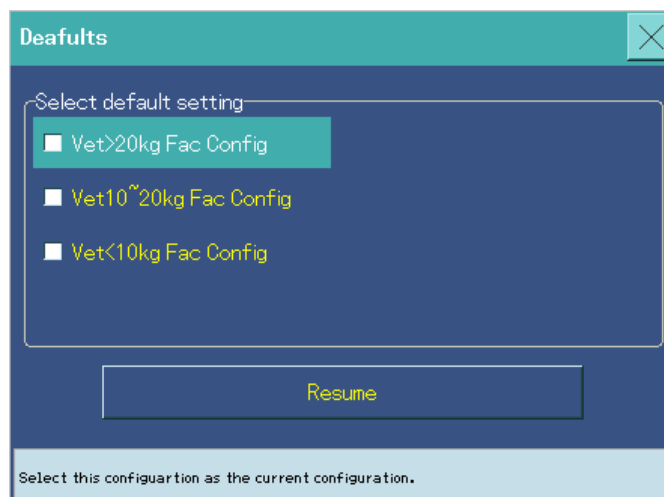

Figure 11.4 Resume Default Setup

Refer to Chapter 3.10.5.

11.7 System State Indicator

Including AC / DC power supply indicator (there are indicator lights on the shell), battery voltage indicator (there are charging indicator lights on the shell), date and time indicator, central site online state indicator, animals' information indicator and demonstrating mode indicator.

11.8 Standby Mode

Select [System]-[Screen Setup]-[Screen Config]-[Shortcut Key >>>] and open shortcut key setup menu, change the [Standby] option to shortcut key, return to main screen and click [Standby] shortcut key, select [OK] in the indicating information interface that has popped up, then you can shift into standby mode. In the standby mode, push any button or click anywhere on the screen and you can end standby mode.

Select 'standby' option in [Animal Manage]-[Discharge Animal] menu, you can also enter standby mode after the monitor executes discharge animals/ clear animal data.

Chapter 12 Battery

12.1 General Description

This series of monitors may at most have 2 rechargeable lithium batteries installed to ensure its normal use in the event of power shutdown. When connected to AC power, the monitor can recharge the battery whether powered on or not. As we do not provide an external charger, the battery can only be recharged in the monitor. In event of sudden power failure, the system will automatically activate the battery to power the monitor without interrupting operation.

When battery power is being used, the battery icon at the lower right corner of the LCD indicates the battery state.



: the battery power is full.



: when the battery power is in the middle, it indicates that the battery capacity is low and should be recharged.



: the battery power will be used up soon. Please recharge it immediately.



Attention

- Before operating the machine, please discharge and recharge the battery one time. Keep the battery power full.
- Please remove the battery before transportation of the monitor or if the monitor will be out of use for a long time.
- To ensure the length of power supply and extend the service life of the battery, it is recommended using the battery at least once a month and recharge it only when the battery power is used up.
- Life expectancy of a battery depends on how frequent and how long it is used. For a properly maintained and stored lithium-ion battery, its life expectancy is about 3 years. For more aggressive use models, life expectancy can be less. We recommend replacing lithium-ion batteries every 3 years.
- The operating time depends on the configuration and operation. For example, monitoring NIBP repeatedly will also shorten the operating time of the batteries.



Warning

- Before use of the rechargeable lithium battery (known as the Battery' below), please read this user manual and the attentions therein thoroughly.
- Please put the battery in a place out of children's reach.
- Be sure to use the provided rechargeable lithium battery or equivalent model. Never use the battery provided by another manufacturer unless otherwise approved.
- Do not use the battery near a source of fire or in an environment over 60°C (140°F); otherwise the battery might explode.
- To avoid getting the battery wet, do not throw the battery into the water.
- Never damage the battery by means of chiseling, knocking, throwing or other methods; or the battery might become heated, smoke, deformed, burned or even explode.
- Immediately go far away from the battery if you find any liquid leakage or if the battery gives out a bad smell. If any electrolytic liquid is spilled onto your skin or clothing, immediately wash with clean water. If any electrolytic liquid enters your eyes, do not wipe but immediately wash them with clean water and seek medical care.

- When the battery is at the end of service life or when the battery gives off a bad odor or becomes deformed, discolored, stop using it and dispose it according to local laws on waste battery disposal.

12.2 Battery Installation

Please change the battery according to the procedures below:

- ◇ Switch off the monitor and pull the AC power cord.
- ◇ In accordance with the direction of the arrow, press the button of the machine on the left side of the battery compartment cover to open the battery compartment cover.
- ◇ Put the holding clamp that is in the middle of battery compartment to the side. Then take out the battery to be changed.
- ◇ With the front of the new battery upward, the electrode connector inward and the notch toward the upper left, insert the battery into the groove. Take care to keep the contact in good condition.
- ◇ If needed, repeat the above procedure to change another battery.
- ◇ Put the holding clamp back to the middle position and close the battery compartment.

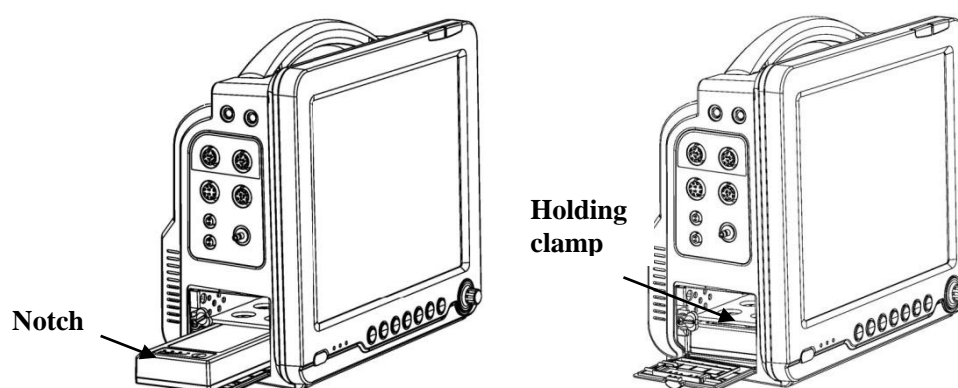

Figure 12.1 Battery Installation



Warning

- The diagram of Battery installation is as 12 inches monitor for example.
- Handle the battery with care. Please do not throw it on the ground or knock it onto other objects.
- Do not connect the positive and negative polarity of the battery wrong; otherwise explosion might happen.

12.3 Battery Recycling

The battery should be changed and properly recycled if the battery is obviously damaged or it performs abnormally during recharging or discharging. Dispose of used battery in strict accordance with the laws.



Warning

- Please do not disassemble or short circuit the battery; otherwise there is fire hazard.
- Burning, explosion or leakage of the battery might cause injury to your body.

Chapter 13 Cleaning and Maintenance

13.1 Cleaning of Monitor

The equipment should be regularly cleaned. Before cleaning, please consult and read the rules of the hospital on equipment cleaning.

Below are the types of cleaners to choose:

- Diluted soap water or diluted ammonia water.
- Sodium hypochlorite (bleach powder for washing).
- 3% hydrogen peroxide.
- 70% ethanol or 70% isopropyl alcohol.

Before cleaning, please first shut off the power supply and, disconnect the power cord and remove the battery. Gently wipe the equipment with a cotton ball or soft cloth soaked with appropriate cleanser. If needed, wipe off the excessive cleanser with dry cloth. After cleaning, put the equipment in a cool and well-ventilated place for natural drying.

 Attention

- If you are going to clean the touch screen during use, please lock it first.

 Warning

- Never wipe the monitor with abrasive materials.
- Never immerse any part of the monitor in liquid or let any liquid leak into the casing.
- Do not pour liquid onto the monitor or its accessories.
- Do not leave any cleanser or disinfectant on the surface of any part of the monitor.

13.2 Disinfecting of Monitor

The disinfecting operation might cause some damage to the monitor. It is suggested that the disinfecting operation be done only when required under the hospital's maintenance plan. The equipment should be clean before disinfection.

Recommended disinfectant: 70% ethanol, 70% isopropyl alcohol or 2% glutaral solution.

 Warning

- Never disinfect the equipment with formaldehyde.
- Never disinfect the sensor with high pressure.

13.3 Fan Cleaning

To ensure smooth air flow and good ventilation, the fan should be cleaned if there is visible dust or other particles on the inlet or outlet.

 Attention

- The cleaning interval should be shortened if the equipment is used in a region or an environment with heavy dust.

13.4 Storage of Monitor

If the monitor will be out of use for a long time, wipe it clean and put it in a packing box for indoor storage at a place that is dry, well ventilated and free from dust or corrosive gas.

13.5 Transport

The monitor may be transported by car, train or plane as agreed in the Contract. Do not throw or knock during transport.

13.6 Inspection of Monitor

Before use or after use for half a year, the monitor should be thoroughly checked by a qualified technician to ensure that the equipment is working normally. If you find that the monitor is slightly damaged during use or its functional display is incomplete or abnormal, do not use the monitor on an animal.

Table 13.1 Maintenance Period

Maintenance items	Maintenance period (years)
Check according to IEC 60601-1	2
NIBP calibration	2
NIBP accuracy test	2
NIBP leakage test	2
CO ₂ calibration and performance testing	1
AG calibration and performance testing	1
Note: You should check the device at least as the period that the above table lists and also the follow items: 1.The measured data isn't correct. 2.The target hospital has the requirements of device inspection. 3.After change the current source or the device drop.	

Chapter 14 Maintenance

14.1 Safety Information



Warning

- The removal or repair of the monitor can only be done by the well-trained professional technicians.
- If you find any problems, please contact us or repair technician.

14.2 NIBP Accuracy Test

Refer to 6.5.9 for details.

14.3 NIBP Overpressure Test

Select [Main Menu]-[Maintenance]-[NIBP Overpressure Test] The characters on the key are changed to [Stop NIBP Overpressure Test]. The ‘Overcharge Testing...’ is displayed on NIBP parameter window. Select [Stop NIBP Overpressure Test] or press [NIBP] key on the panel to manually stop the NIBP Overpressure Test.



Warning

- NIBP Overpressure Protection Test: It should not exceed 300 mmHg (39.9 kPa) for the >20 kg, and not exceed 150 mmHg (19.9 kPa) for the 10~20 kg or <10 kg.

14.4 NIBP Leakage Test

Refer to 6.5.8 for details.

14.5 User Maintain

Select [Main Menu]-[Maintenance]-[User Maintain>>]. Enter the user maintain password to open [User Maintain] menu.

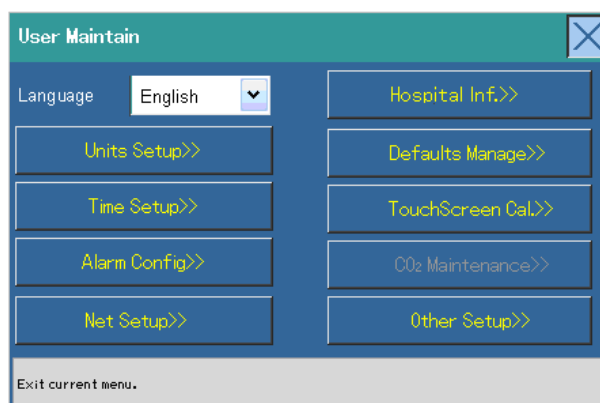

Figure 14.1 User Maintain Menu

◆ Language

Set the language of the monitor's display language, this setting is associated with the language configuration in the Factory Maintain, when the language configuration for certain kinds of language, then the language setting in the user maintain are the same several languages.

◆ **Hospital Information**

Input name of hospital and department name.

◆ **Units Setup**

Select [Unit Setup>>] to open [Unit Setup] Menu, in which you can select the animal's height, weight, monitor CO₂ pressure, blood pressure, CVP, temperature and ST voltage.

Height: cm, inch

Weight: kg, lb

CO₂: mmHg, kPa, %

Blood Press: mmHg, kPa

CVP: mmHg, kPa, cmH₂O

Temp: °C, °F

ST Voltage: mV, mm

O₂: mmHg, kPa, %

Show Unit: Disable, Enable. If you select 'Enable', the parameters will be shown in the selected unit on the parameter window of main screen. If you select 'Disable', no parameters will be shown.

◆ **Time Setup**

Refer to 3.9.4 for details.

◆ **Alarm Config**

Refer to 7.6 for details.

◆ **Net Setup**

By selecting [Net Setup>>], you may set the bed number, network mode (wired or wireless), local IP address, server IP address and default gateway. After finishing the setting, select [Storage Settings] to confirm.

◆ **Defaults Manage**

Refer to 3.10 for details.

◆ **Touch Screen Calibration**

Select [Touch Screen Cal.], so that the cross icon ' + ' will be shown sequentially at different positions on the screen. Click at the center point of ' + ' in sequence to make calibrations. After the calibration is finished, the monitor will display the prompt: press [Retry] to calibrate again; Press [OK] to save the new touch screen parameters and exit; Press [Cancel] to cancel the saving of new parameters and exit. The user may select as needed.

◆ **Maintenance of CO₂ Module**

Refer to 6.8.5 and 6.8.6 for details.

◆ **Other Setup**

Notch Filter: 50Hz, 60Hz. It is used for setting the frequency of power frequency wave trap.

ECG Off Level: High, Mid and Low. The user may set the level of ECG lead off. The alarm prompt will also display the corresponding alarm level.

SpO₂ Off Level: High, Mid and Low. The user may set the level of SpO₂ sensor fall. The alarm prompt will also display the corresponding alarm level.

Tone Modulate: On or Off. Set if needed to modulate SpO₂ value to the pulse rate.

While DC: Fan On or Fan Off. It is used for choosing to stop the fan when the monitor is powered by the battery.

Record Bold Curve: On or Off. If you select On, the wave curve on the log paper will be bold.

Curve Draw: by Ladder or Color Steps. It is used for setting the mapping method for the waveform on the screen.

Wave Lines: Thin, Middle or Thick. It is used for selecting the coarseness of the waveform in vertical direction on the screen.

Auto Screen Layout: On or Off. It is used for setting to display that the module is turned off. When a sensor for the parameter is not activated is inserted on the screen configuration, the system will automatically display the data and waveform of the parameter if this option is activated. If this option is deactivated, the current screen layout will not change, but there will be a prompt 'XX not be choosed to display' appearing on the lower part of screen. **Special: if Resp parameter is not activated in screen configuration, the screen will always display the message 'Resp cannot be choosed to display' instead of the Resp data and waveform if the ECG lead is inserted, no matter if the ' Auto Screen Layout ' is set to On or Off.**

14.6 Demo Model

Select [Main Menu]-[Maintenance]-[Demonstrate]. Input the demo password to enter the demo mode.

Attention

- The demo mode is used for factory demonstration or hospital training purposes. This function is provided with password protection. During demonstration, all waveforms and data are virtual, and some menus and functions are disabled

14.7 Monitor System Information

Select [Main Menu]-[Maintenance]-[System Info>>]. From this window, you may view information such as the startup time and last startup time of the machine, system compiles time, machine ID and configuration info.

Select [Configuration Info>>] from the system information window. A window as shown in Figure 14.2 will pop up.

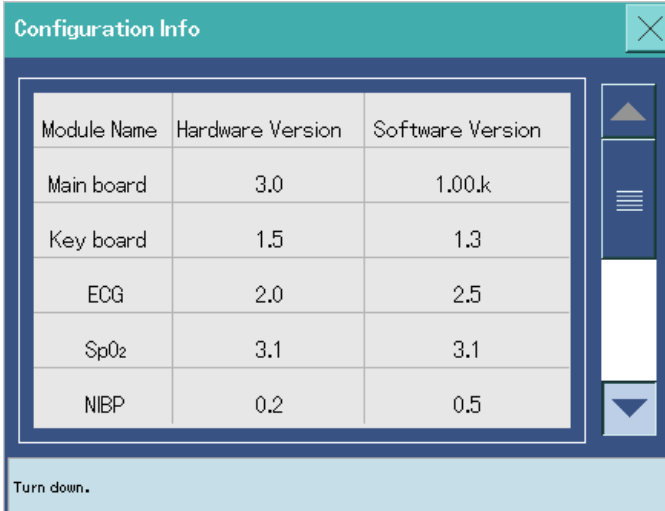

Module Name	Hardware Version	Software Version
Main board	3.0	1.00.k
Key board	1.5	1.3
ECG	2.0	2.5
SpO ₂	3.1	3.1
NIBP	0.2	0.5

Turn down.

Figure 14.2 Configuration Information

This window displays the module configuration, including: Module Name, Hardware Version and Software Version.

-- The Blank Page --

Chapter 15 Troubleshooting and Solutions

15.1 Check before Use

Before use of the monitor, please perform the following inspections:

- Check whether there is any mechanical damage.
- Check all the exposed wires, inserts and accessories.
- Ensure that the monitor is properly grounded.
- Watch the voltage fluctuation of the local grid. If it exceeds the permissible range, it is suggested you add a voltage stabilizing device.

If there is sign that the monitor function is damaged, do not use this equipment to monitor animal. In this case, please contact the dealer or call us directly.

After each repair, a thorough inspection of the monitor must be done by a qualified technician.



Warning

- The user shall not open the casing by you.
- If the hospital does not implement the repair plan, it might cause the monitor to malfunction or even cause risk to animal health.
- If the sensor or cable has any sign of damage or deterioration, please stop using the equipment.
- To eliminate unnecessary problems and avoid affecting the normal use, do not adjust the meters or other adjustable elements inside the machine, unless otherwise permitted.

15.2 The Monitor cannot be Turned On

- If AC power is used, check if the power cord is in good condition and if it has good contact with the monitor and the power socket.
- If DC power is used, check if the battery is correctly inserted into the machine (refer to Chapter 12 Battery). Please use AC power if the battery power is low.

If the equipment still cannot be turned on after above procedures, please contact the manufacturer.

15.3 The Monitor cannot be Shut Down Normally with ON/OFF Switch

- Keep pressing ON/OFF for 3s or longer to shut down the equipment forcibly. (If the equipment cannot be forcibly shut down, please unplug the power cord and remove the battery).
- Restart the equipment and operate by going to [Main Menu]-[Animal Manage]-[Clear Animal Data].

If the equipment still cannot be shut down normally, please contact the manufacturer.

15.4 No Display on Screen

- Check if the machine has been turned on normally (Refer to 15.1).
- Press 'PAUSE' key on front panel slowly and repeatedly. If the backlight (red) on this key becomes bright and dark intermittently, the problem might be that the screen wire is in poor contact or the LCD has failed. Please contact the manufacturer.

15.5 Interference to ECG Signal Too High or Baseline Too Coarse

- Check if the electrode is correctly placed and if the electrode is effective or expired.
- Check if the cable plug is properly inserted. If there is no ECG wave, please check if the cable is disconnected.
- Check if the power socket is correctly grounded as per standard.
- Check if the grounding wire for the monitor is securely connected to ground.

15.6 No Measured Result of NIBP

Check if the cuff for blood pressure is attached to the correct position on the arm as required in the user's manual. Check the cuff for leakage. Check if the air hose connector is tightly inserted into NIBP socket on front panel and if the setting for animal type is compatible with the type of cuff. If there still is no result, please contact the manufacturer.

15.7 No Measured Result of SpO₂

- Check if the light in the SpO₂ sensor blinks. (Attention: DO NOT look at the blinking light directly, as it might cause injury to your eyes).
- Check if the SpO₂ probe is securely connected to SpO₂ port on the front panel.
- Examine the body of the animal for any abnormality where the SpO₂ sensor is placed.

If there still is no result, please contact the manufacturer.

15.8 Measure Result of EtCO₂ is Low (Optional)

- Ensure that CO₂ module is correctly calibrated (At least one effective calibration is done prior to shipment). Attention: calibration without use of standard gas or calibration to the wrong standard gas concentration will result in reading error. In this case the machine will not give any warning. It is suggested to have the machine calibrated by a third-party authoritative organization or by the manufacturer.
- For by-pass module, check the full length of the air tube from the inlet of main tube (or sampling tube) to the dewatering bottle to ensure that the connector is securely tightened, or if there is hole in the tube, or if the dewatering bottle is damaged or cracked.
- For mainstream module, check if the air tube is tightly connected to the main tube and if the sensor is clamped to the correct position on the air tube adapter. When changing the adapter or a new animal, please zero the scale before use (refer to 6.8.6).

If the problem remains, please contact the manufacturer.

15.9 The Sound of Sidestream CO₂ Pump Becomes High (Optional)

Ensure the air tube is free of any foreign particles such as the water droplets, sputum or blood clots. Check if the color of the filter wool inside the water trap is dark (brown or black). If yes, change the water trap. If the problem remains, please contact the manufacturer.

15.10 Body Temperature without Numerical Value or Inaccurate Readings

- No value
First check whether the probe is inserted properly and then check whether the probe has physical fracture and contact the manufacturer.
- Inaccurate readings
First check whether the metal part of the probe sensor is in close contact with the tested part and then verify that whether the measurement time is more than four minutes, ensure that the animal or the animal's position being tested is essentially stationary; if fever cramps or convulsions cause the sensor loose, or axilla and other parts that have dense body hair cause slow heat conduction or error, the hair should be shaven or select other suitable positions for measurement.



Attention

- If the machine has problems when you are using our monitor, you may check as described above. If the problem remains, please contact the local dealer or call us directly.

Appendix A Packaging and Accessories

A.1 Packaging

The equipment is packed in a high-grade corrugated carton by two layers. The carton is lined with foam to ensure the monitor will not be damaged during normal handling.

12 inches monitor:

Gross weight: about 7.5 kg

Dimension: 440(L) mm×390(W) mm×325(H) mm.

15 inches monitor:

Gross weight: about 9.0 kg

Dimension: 440(L) mm×400(W) mm×375(H) mm

A.2 Accessories

ECG		Clamp veterinary electrode (Veterinary clip 5-lead DECG-FJ03 Φ3mm Φ4mm,snap multi - limbs clip,304 stainless steel)	10 pcs
			1 Set
		Veterinary ECG leads(monitor 5-lead cable, split, 12P round plugs, with a 1K resistor, snap, American Standard)	1 Set
SpO₂	SpO₂-BJ	Oxygen extension cable (10P round plug to the all-inclusive the DB9F)	1 piece
		Oxygen probe (for veterinary ear clip, split, S0010G-S series iM / PM)	1 piece
	SpO₂ Masimo (Optional)	LNOP Y-I, > 1 kg, Multi-position	1 piece
		LNOP TC-I, > 30 kg, Earlobe	1 piece
		LNOP TF-I, > 30 kg, Forehead	1 piece
	SpO₂ Nellcor (Optional)	Dura-Y [®] D-YS, > 10 kg, Multi-position	1 piece
		D-YSE Ear clip, > 30 kg, Multi-position	1 piece
D-YSPD Pedicheck®10~20 kg clip, 3 kg~40 kg, Multi-position		1 piece	
NIBP		Cuff connection tube (Hard pipe bright side, 3m in length at both ends with metal gas line connection)	1 piece
		Veterinary with a metal connector, arm circumference 7cm-13cm, surface without screen printing, for iM series.	1 piece
		Veterinary with a metal connector, arm circumference 10cm-19cm, surface without screen printing, for iM series.	1 piece
		Veterinary with a metal connector, arm circumference 18cm-26cm, surface without screen printing, for iM series.	1 piece
		iM series of veterinary monitors blood pressure cuff tab	
Temp		Veterinary cavity temperature probe rectal temperature probe	1 piece
IBP (Optional)		IBP cable	1 Set
		Disposable IBP sensor	1 piece
EtCO₂	Respironics Mainstream CAPNOSTA T5 (Optional)	Airway adapter (for > 20 kg/10~20 kg)	1 piece
		Airway adapter (for < 10 kg)	1 piece
		Mask	1 piece
		Cable fixing strap	1 piece
		Sensor clamp	1 piece
		Sensor	1 piece
	Phasein Mainstream	Airway adapter (for > 20 kg/10~20 kg)	1 piece
		Airway adapter (for < 10 kg)	1 piece

Appendix A Packaging and Accessories

	IRMA (Optional)	Mask	1 piece
		Cable fixing strap	1 piece
		Sensor clamp	1 piece
		Sensor	1 piece
	Phasein Sidestream ISA (Optional)	ISA Sidestream Analyzer	1 set
		Nomoline sampling tube	1 piece
		Tee	1 piece
	Respironics Sidestream LoFlo (Optional)	LoFlo Sidestream Analyzer	1 set
		Disposable nasal cannula	1 piece
		Disposable oral-nasal cannula	1 piece
	Kingst Sidestream KM7002-V33 (Optional)	Water trap	1 piece
		Sampling tube	1 piece
Tee		1 piece	
Water trap clamp		1 piece	
EtCO₂	CPT Sidestream CO₂WFA (Optional)	Water trap	1 piece
		Sampling tube	1 piece
		Tee	1 piece
		Water trap clamp	1 piece
AG Sidestream (Phasein)	Sampling tube	Nomoline (without condensation) Sampling tube	1 piece
AG Mainstream (Phasein)	Airway adapter	Mainstream AG Airway adapter	1 piece
Others		Power cable (V3203C+V1625A, 10A/250V)/ power cable, European, 1.8m~2m, black, H05VV-F/3G*0.75 AP24/AC24	According to customer requirements with one (GB or European standard)
		Ground wire (external ground wire UL1015, 14AWG, length 4m, with a crown spring jacks and alligator clip)	1 piece
		User manual	1 piece
		Warranty Card	Duplicate
		Quality certificate	1 sheet
		Packing List	1 sheet

Attention: The accessories vary with your options and required configuration. See the Packing List for details.

Appendix B Product Specifications

B.1 Safety Specifications

B.1.1 Product Classification

For classification of this series of monitors comply with IEC60601-1, please refer to Table B.1.

Table B.1 Module Classification

Components	Type of Protection Against Electric Shock	Degree of Protection Against Electric Shock	Degree of Protection Against harmful ingress of water	Degree of Protection Against hazards of Explosion	Mode of Operation
Main unit	I	Not marked	Ordinary	Not suitable	Continuous
ECG (Resp) Module	NA	CF(*)			
IBP Module (Optional)					
NIBP Module					
Temp Module					
SpO ₂ Module					
CO ₂ Module (Optional)		BF(*)			
AG Module (Optional)					

ATTENTIONS:

- I: Class I Equipment
- BF: Type BF applied part (The symbol ‘*’ indicates the availability of defibrillation-proof function).
- CF: Type CF applied part (The symbol ‘*’ indicates the availability of defibrillation-proof function).
- NA: Not applicable.
- Ordinary Equipment: No protection against the ingress of water.
- Not suitable: Equipment is not suitable for use in the presence of a flammable anesthetic mixture with air with oxygen or nitrous oxide.

B.1.2 Environment Specifications

Equipment Environment (Host, Recorder, C.O. Module and IBP Module)			
Item	Temperature	Humidity (Non-Condensing)	Atmospheric Pressure
Operating	0°C ~ 40°C (32°F ~ 104°F)	15% ~ 80%	442.5 mmHg ~ 805.5 mmHg (59 kPa ~ 107.4 kPa)
Storage&Transport	-20°C ~ 55°C (-4°F ~ 140°F)	10% ~ 93%	165 mmHg ~ 805.5 mmHg (22 kPa ~ 107.4 kPa)
AG Module			
Item	Temperature	Humidity (Non-Condensing)	Atmospheric Pressure
Operating	0°C ~ 40°C (32°F ~ 104°F)	10% ~ 95%	393.8 mmHg ~ 900 mmHg (52.5 kPa ~ 120 kPa)
Storage&Transport	-40°C ~ 75°C (-40°F ~ 167°F)	5% ~ 100%	375 mmHg ~ 900 mmHg (50 kPa ~ 120 kPa)
Note: You can refer to B.6 Measuring Specifications to get the environment specifications of optional configurations			

B.1.3 Power Specifications

(AC) Input Voltage	100 V ~ 240 V
Input Power	75 VA
Frequency	50 Hz/60 Hz (Allowable frequency error ± 1 Hz)
Fuse	3.15A/250V
Safety Classification	Class I, Type BF, CF

B.2 Physical Specifications

Host	12 inches monitor	15 inches monitor
Weight	About 4.5 kg	About 5.5 kg
Size (L×W×H)	310 mm×163 mm×285 mm	370 mm×187 mm×313 mm

B.3 Hardware Specifications

Display	
Type	TFT LCD Screen
Dimensions	12.1 inches (12 inches monitor), 15 inches (15 inches monitor)
Resolution	800×600 pixels (12 inches monitor), 1024×768 pixels (15 inches monitor)
Screen Brightness	10-level, adjustable
LCD View Angle	Horizontal / vertical view angle at least 150°/120°
Recorder	
Type	Thermal array recorder
Horizontal Resolution	16 dots/mm (Paper Speed: 25.0 mm/s)
Vertical Resolution	8 dots/mm
Printing Paper Size	50 mm×20 mm
Paper Speed	12.5 mm/s; 25.0 mm/s; 50.0 mm/s
Waveform	Max. 3 waveforms
Battery	
Dimensions	182 mm×71 mm×25.5 mm
Weight	0.3 kg
Type	Rechargeable lithium battery

Rated voltage	14.8 V
Battery Capacity	4.4 Ah
Length of Power Supply	In environment temperature ranging from 20 °C to 30 °C and in standard configuration (the SpO ₂ sensor connects, the ECG cable and Temp cable disconnect, the “Measure Mode” of NIBP is “Auto” and the “Interval” is 15 minutes), the continuous working time of a single battery is not less than 5 hours.
Time for recharging battery to 90% from zero power state	In environment temperature ranging from 20 °C to 30 °C and with the machine turning off, the charging time is not more than 12 hours to charge the battery to 90%.
Shutdown Delay	0 s, 0.5 s, 1 s, 1.5 s, 2 s
Host LED	
Physiological Alarm Indicator Lamp	1 (Dual color yellow & red)
Technical Alarm Indicator Lamp	1 (Blue)
Power Switch Indicator Lamp	1 (Green)
AC Power Indicator Lamp	1 (Green)
Battery Power Indicator Lamp	1 (Green)
Battery Charging Indicator Lamp	1 (Green) (Only for 12 inches monitor)
Keypad Backlight	5 (White)
Alarm Pause Key Backlight	1 (Red)
Speaker	Give out alarm sound (45 dB~85 dB), keystroke sound and QRS sound. Alarm sound complies with IEC 60601-1-8
Interface	
Power	1 AC power port
Network	Standard RJ45 network port, which can network with the central monitoring system and transmit all the Veterinary Monitored data to the central monitoring system.
USB	USB disk supported. For the manufacturer to upgrade and service the application software, and export data (Structurally 2 USB host interfaces supported)
VGA	Supported, for connection of external display
Analog Output Port	1 piece. It can be connected to oscilloscope for output of the analog signals.
Nurse Call System Interface and Defibrillation Synchronization Interface	1 piece. It can be connected to port of the nurse call system or the defibrillator.
Equipotential Terminal Port	1 piece
ECG Analog Signal Output	
Bandwidth (-3 dB, reference 10Hz)	Surgery mode: 1 Hz~15 Hz Monitor mode: 0.5 Hz~40 Hz Diagnose mode: 0.05 Hz~150 Hz
Max. Transmission Delay	25ms (Wave filter closed under diagnose mode)
Sensitivity	1 V/mV ±5%
Accuracy of input signal reproduction	Using the method described in 4.2.7.1 of AAMI EC11 to test the overall system error, which is within ±5%; Using method A and D described in 4.2.7.1 of AAMI EC11 to test frequency response. Because of sampling characteristics and the asynchronism between sample rate and signal rate of the ECG module, digital systems may produce a noticeable modulating effect from one cycle to the next. This phenomenon, which is not physiologic, shall be clearly described in the operator’s and service manuals.
IBP Analog Signal Output	
Bandwidth (-3 dB, reference 10Hz)	0 Hz~50 Hz
Max. Transmission Delay	30 ms (Filter closed)
Sensitivity	0.01 V/mmHg ±5%

B.4 Data Storage

Trend Data	Short Trend (Trend Window Time 4 min, 40 min, 2 h) Resolution of Trend Chart 5 s, 30 s, 1 min, 10 min): Max. storage time: 72h. Long trend (Trend Window Time 4 h, 16 h, 32 h, 48 h) Resolution of Trend Chart 15 min, 30 min, 1 h, 2 h, 3 h): Max. storage time: 480h.
Parameter Alarm Event	700 parameter alarm events and manual events, as well as the parameter waveform related to the occurring time, wave length 10s
NIBP Measuring Result	Max. 1000 groups
Single-Channel ECG Waveform	Max. 2h
Holographic Waveform	Max. 2 min (Power cutoff storage not supported)

B.5 Wireless Network

Applicable Standard	IEEE 802.11b/g, compatible with wifi
Safe to use distance	20 cm
Frequency Range	2.412 GHz~2.472 GHz
Signal Path	1-13 (China)
Transmission Distance	30 m (Open area without obstruction)

B.6 Measuring Specifications

B.6.1 ECG Monitoring

Input Mode	3-Lead ECG input (Optional) 5-Lead ECG input (Standard)
Lead Selection	I, II, III (Optional) I, II, III, aVR, aVL, aVF, V I, II, III, aVR, aVL, aVF, V1~V6 (Optional)
Lead Standard	AHA, IEC
Measuring Range of Heart Rate	>20 kg: 15 bpm~300 bpm 10~20 kg: 15 bpm~350 bpm <10 kg: 15 bpm~350 bpm
Heart Rate Display Tolerance	±1% or ±1 bpm, whichever is higher
Sensitivity	1.25 mm/mV (×1/8), 2.5 mm/mV (×1/4), 5.0 mm/mV (×1/2), 10.0 mm/mV (×1), 20.0 mm/mV (×2), 40.0 mm/mV (×4), Auto. Error: ±5%
Resolution Stability	The resolution change 1 minute after the instrument is powered on does not exceed 0.66% per minute. The total change within 1h does not exceed any available fixed gain setting by ±10%.
Sweep Speed	6.25 mm/s, 12.5 mm/s, 25.0 mm/s, 50.0 mm/s. Error: ±10%
Noise Level	≤30 μV _{p-p}
Input Circuit Current	≤0.1 μA
Input Impedance	≥2.5 MΩ
Patient Leakage Current	< 10μA
ESU Proof	Cutting Mode: 300 W Coagulation Mode: 100 W Recovery Time: ≤10 s
ESU Noise Inhibition	Tested acc. to 5.2.9.14 of ANSI/AAMI EC 13:2002: 1) The ECG signal track does not disappear; 2) Change in heart rate does not exceed 10% of the heart rate when the electrosurgical knife is not activated.

CMRR	Diagnose Mode: ≥ 89 dB Surgery & Monitor Mode: ≥ 100 dB
Time Constant	Monitor Mode: ≥ 0.3 s Diagnose Mode: ≥ 3.2 s
Frequency Response	Surgery Mode: 1 Hz-15 Hz; Monitor Mode: 0.5 Hz-40 Hz; Diagnose Mode: 0.05 Hz-150 Hz.
ECG Parameter Frequency Characteristics	Surgery Mode: Meet (+0.4 dB ~ (-3.0 dB)) requirements at 15 Hz. Monitor Mode: Meet (+0.4 dB ~ (-3.0 dB)) requirements at 0.5 Hz ~ 40 Hz. Diagnose Mode: Meet (+0.4 dB ~ (-1.0 dB)) requirements at 0.05 Hz ~ 60 Hz. Meet (+0.4 dB ~ (-3.0 dB)) requirements at 61 Hz ~ 150 Hz.
Notch	Monitor & Surgery Mode: notch filter automatically activated at 50 Hz/60 Hz Diagnose Mode: Notch filter manually activated or deactivated at 50 Hz/60 Hz
Range of Electrode Polarized Voltage	± 300 mV d.c.
Lead Fall Testing Current	Measuring Electrode: < 0.1 μ A Drive Electrode < 1 μ A
Pacemaker Pulse	
Pacemaker Pulse Display Capacity	Pace-making mark can be displayed for the following pacemaker pulses: Pulse Amplitude: ± 2 mV ~ ± 100 mV Pulse Width: 0.1 ms ~ 2 ms Pulse Rise Time: 10 μ s ~ 100 μ s Pacemaker pulse should be no overshoot
Pacemaker Pulse Suppression Capacity	The monitor can inhibit the pacemaker pulse that conforms to the following conditions: Pulse Amplitude: ± 2 mV ~ ± 100 mV Pulse Width: 0.1 ms ~ 2 ms Pulse Rise Time: 10 μ s~ 100 μ s Pacemaker pulse should be no overshoot
Alarm Limit Specifications	
Range	
Upper Limit of ECG Heart Rate	Alarm upper limit for > 20 kg: (Lower limit+2) bpm ~ 300 bpm Alarm upper limit for 10~20 kg: (Lower limit+2) bpm ~ 350 bpm Alarm upper limit for < 10 kg: (Lower limit+2) bpm ~ 350 bpm
Lower Limit of ECG Heart Rate	Alarm lower limit for > 20 kg: 15 bpm ~ (Upper limit-2)bpm Alarm lower limit for 10~20 kg: 15 bpm ~ (Upper limit-2)bpm Alarm lower limit for < 10 kg: 15 bpm ~ (Upper limit-2)bpm
Resolution	± 1 bpm
Accuracy	The tolerance of alarm limit setting is ± 1 bpm. In addition, the ECF signal alarm below the publicized lower limit of the alarm will not fail. If the alarm is not disabled, the alarm will not fail if you enter the ECG input signal higher than the upper limit of alarm up to 300 bpm (350 bpm for < 10 kg and 10~20 kg).
HR	
Heart Rate Testing Amplitude	± 0.3 mV ~ ± 5 mV
Resolution	1 bpm
Alarm Time for Tachycardia	Acc. to ANSI/AAMI EC13:2002 Part 4.1.2.1 g). 4ah-Range: 11 s 4a-Range: 11 s 4ad-Range: 11 s 4bh-Range: 11 s 4b-Range: 11 s 4bd-Range: 11 s
Heart Rate Average	Acc. to ANSI/AAMI EC13:2002 Part 4.1.2.1 g). The average heart rate is obtained by the

	<p>method below: If the interval of the last continuous 3 RR is higher than 1200ms, the heart rate is averaged based on the most recent 4 RR intervals; otherwise, the heart rate is averaged based on the most recent 12 RR intervals. The heart rate displayed on the screen is refreshed every second.</p>
Response to Irregular Rhythm of the heart	<p>Acc. to ANSI/AAMI EC13:2002 Part 4.1.2.1 e). The heart rate displayed after 20s stabilizing period is: 3a (Ventricular bigeminy) $\sim 80 \pm 1 \text{ bpm}$ 3b (Slow alternating ventricular bigeminy) $\sim 60 \text{ bpm} \pm 1 \text{ bpm}$ 3c (Rapid alternating ventricular bigeminy) $\sim 120 \text{ bpm} \pm 1 \text{ bpm}$ 3d (Bidirectional systoles) $\sim 90 \text{ bpm} \pm 6 \text{ bpm}$</p>
Response Time to Heart Rate Change	<p>Acc. to ANSI/AAMI EC13:2002 Part 4.1.2.1 f). Increase of heart rate: response time $\leq 11 \text{ s}$ Decrease of heart rate: response time $\leq 11 \text{ s}$</p>
High T-wave Suppression Capacity	<p>Acc. to ANSI/AAMI EC13:2002 Part 4.1.2.1 c). The heart rate monitor inhibits all T-waves with amplitude lower than 1.2 mV, 100msQRS wave groups, T-wave period 180 ms and QT period 350ms.</p>
Arrhythmia Type	<p>a) Monitoring type: Asystole, VFib/VTac, VTac, Ventricular bradycardia, Extreme-Tachy, Extreme-Brady, Non-Sustained VT, PVC, Tachycardia, Bradycardia, VR(ventricular rhythm), V-Bigeminy, V-Trigeminy, Irr.Rhythm, PVCs/min, Run PVCs>2, Couplet, R on T, Multiform, HeartBeat Pause, Missed Beats b) Pace-making: Pacemaker not captured (PNC), Pacemaker not paced (PNP).</p>
ST Interval Measuring	
Range	(-2.0 mV)~(+2.0 mV)
Accuracy	Measuring Tolerance: measuring tolerance within (-0.8 mV)~(+0.8 mV) is $\pm 0.02 \text{ mV}$ or $\pm 10\%$, whichever is higher. It not defined for other ranges.
ST Interval Updating Interval	A single heart beat interval or 1s, whichever is higher.

B.6.2 Respiration (Resp) Monitoring

Measuring Method	Chest Impedance Method
Measuring Lead	Lead I and II for selection. Lead I defaulted.
Respiration Exciting Waveform	< 300 μA , Sine signal, 62.8 kHz ($\pm 10\%$)
Range of Respiration Impedance	0.5 Ω ~3 Ω
Range of Base Impedance	250 Ω -2000 Ω (Use of ECG cable with 1k Ω resistor)
Differential Input Impedance	> 2.5 M Ω
Bandwidth	0.2 Hz~2 Hz (-3 dB)
Waveform Sensitivity	$\times 1/4$, $\times 1/2$, $\times 1$, $\times 2$, $\times 4$, Auto
Sweep Speed	6.25 mm/s; 12.5 mm/s; 25.0 mm/s
Resolution	1 rpm
Accuracy	$\pm 2 \text{ rpm}$
Asphyxia Alarm	Off, 10 s, 15 s, 20 s, 25 s, 30 s, 35 s, 40 s
RR	
Range	<p>Monitoring Range for > 20 kg: 0 rpm~120 rpm Monitoring Range for 10 ~20 kg: 0 rpm~150 rpm Monitoring Range for < 10 kg: 0 rpm~150 rpm</p>
Resolution	1 rpm
Respiration Monitoring Tolerance	<p>Within 7 rpm~150 rpm, the measuring error is $\pm 2 \text{ rpm}$ or $\pm 2\%$, whichever is higher. The tolerance is not defined for other ranges.</p>

Asphyxia Alarm Tolerance	Within 10 s~40 s (Increase/decrease by 5s for each rotation of the knob), the asphyxia alarm tolerance is ± 5 s.
Alarm Limit Specifications	Range
RR Upper Limit	Alarm upper limit for >20 kg: (Lower limit+2) rpm ~100 rpm Alarm upper limit for 10 ~20 kg: (Lower limit+2) rpm ~100 rpm Alarm upper limit for <10 kg: (Lower limit+2) rpm ~100 rpm
RR Lower Limit	Alarm lower limit for >20 kg: 0 rpm ~ (Upper limit-2) rpm Alarm lower limit for 10 ~20 kg: 0 rpm ~ (Upper limit-2) rpm Alarm lower limit for <10 kg: 0 rpm ~ (Upper limit-2) rpm

B.6.3 SpO₂ Monitoring

Alarm Limit Specifications	Range
SpO ₂ Upper Limit	(Lower limit+1)% ~100%
SpO ₂ Lower Limit	80% ~ (Upper limit-1)%
Accuracy Tolerance	$\pm 1\%$ of the setting
Sensing element	Optical power <15 mW Red light wavelength: 658 nm~664 nm, infrared light: 897 nm~915 nm Information on the wavelength range is particularly useful for clinicians (e.g. in optical dynamic therapy)

SpO₂ Module

Monitoring Parameters	SpO ₂ and Pulse Rate (PR)
Range	0% ~ 100%
Resolution	1%
Data update period	1 s
Accuracy	Within 70%~100%, the measuring tolerance is $\pm 2\%$. Within 0%~69%, the measuring tolerance is not defined.

Masimo Oximeter Module

Monitoring parameter	Pulse oximetry (SpO ₂) and pulse rate (PR)
Range	1%~100%
Resolution	1%
Accuracy	> 20 kg and <10~20 kg: In the range of 70%~100%, the measurement error is ± 2 ; < 10 kg: In the range of 70%~100%, the measurement error is ± 3 ; In the range of 0%~69%, the measurement error is not defined.
Average time	2 s-4 s, 4 s-6 s, 8 s, 10 s, 12 s, 14 s, 16 s
Data update period	1 s
Weak perfusion condition	Pulse amplitude: >0.02%; Light transmittance: >5%.
Weak perfusion SpO ₂ accuracy	> 20 kg and <10~20 kg: $\pm 2\%$ < 10 kg: $\pm 3\%$.

Nellcor Oximeter Module

Monitoring parameter	Pulse oximetry (SpO ₂) and pulse rate (PR)
Range	1%~100%
Resolution	1%
Data update peiriod	1 s
Accuracy	> 20 kg: In the range of 70 %~100 %, the measurement error is ± 2 ; < 10 kg: In the range of 70 %~100 %, the measurement error is ± 3 ; Insufficiency: In the range of 70 %~100 %, the measurement error is ± 2 ; In the range of 0 %~69 %, the measurement error is not defined.

B.6.4 PR Specifications

Alarm Limit Specifications	Range
PR Upper Limit	Alarm upper limit for > 20 kg: (Lower limit+2) bpm~250 bpm Alarm upper limit for < 10~20 kg: (Lower limit+2) bpm~250 bpm Alarm upper limit for < 10 kg: (Lower limit+2) bpm~250 bpm
PR Lower Limit	Alarm lower limit for > 20 kg: 25 bpm~ (Upper limit-2)bpm Alarm lower limit for < 10~20 kg: 25 bpm~ (Upper limit-2)bpm Alarm lower limit for < 10 kg: 25 bpm~ (Upper limit-2)bpm

PR from SpO₂ Module

Range	30 bpm~250 bpm
Resolution	1 bpm
Measuring Tolerance	± 2 bpm
Average Time	8 s

PR from Masimo SpO₂ Module

Range	25 bpm~240 bpm
Resolution	1 bpm
Measuring Tolerance	The measuring tolerance is ± 3 bpm or $\pm 1\%$, whichever is higher.
Average Time	2 s-4 s, 4 s-6 s, 8 s, 10 s, 12 s, 14 s, 16 s

PR from Nellcor SpO₂ Module

Range	20 bpm~300 bpm
Resolution	1 bpm
Measuring Tolerance	> 20 kg and < 10 kg: 20 bpm~250 bpm: ± 3 bpm Insufficiency: 251 bpm~300 bpm: not defined.

PR from IBP

Range	30 bpm~350 bpm
Resolution	1 bpm
Measuring Tolerance	30 bpm~200 bpm: ± 1 bpm or $\pm 1\%$, whichever is higher; 201 bpm~350 bpm: $\pm 2\%$.

B.6.5 NIBP Monitoring

Measuring Method	Automatic oscillometric method				
Safety Requirements	Acc. to ANSI/AAMI SP-10 Non-invasive Automated Blood Pressure Monitor, Part 4.4				
Work Mode	Manual, Auto, STAT Measuring				
Measuring Time under Continuous Mode	5 min				
Measuring Interval under Auto Mode	1 min, 2 min, 3 min, 4 min, 5 min, 10 min, 15 min, 30 min, 60 min, 90 min, 2 h, 4 h, 3 h, 8 h, Timer interval error: < 10 s				
Resolution	1 mmHg (0.133kPa)				
Nominal Range of Monitoring	Blood Pressure (unit)	>20 kg	10~20 kg	<10 kg	
	Systolic Pressure	mmHg	40~270	40~200	40~135
		kPa	5.3~35.9	5.3~26.6	5.3~18.0
	Mean Pressure	mmHg	20~230	20~165	20~110
		kPa	2.7~30.6	2.7~22.0	2.7~14.7
	Diastolic Pressure	mmHg	10~210	10~150	10~100
kPa		1.3~27.9	1.3~20.0	1.3~13.3	
Range of Initial Inflation Pressure Setting	>20 kg: 80 mmHg~280 mmHg (10.7 kPa~37.3 kPa) 10~20 kg: 80 mmHg~210 mmHg (10.7 kPa~27.9 kPa) <10 kg: 60 mmHg~140 mmHg (8.0 kPa~18.6 kPa)				
Default of Initial Inflation Pressure	>20 kg: 160 mmHg (21.3 kPa) 10~20 kg: 140 mmHg (18.6 kPa) <10 kg: 90 mmHg (12.0 kPa)				
Measuring Tolerance of Pressure Source Testing	±3 mmHg (±0.4 kPa)				
Overpressure Protection	>20 kg state: When the pressure in cuff exceeds 297 mmHg (39.5 kPa)±3 mmHg (0.4 kPa), the control valve shall relieve the pressure. 10~20 kg state: When the pressure in cuff exceeds 240 mmHg (31.9 kPa)±3 mmHg (0.4 kPa), the control valve shall relieve the pressure. <10 kg state: When the pressure in cuff exceeds 147 mmHg (19.6 kPa)±3 mmHg (0.4 kPa), the control valve shall relieve the pressure.				
Alarm Limit Specifications	Range				
Upper Limit of Systolic Blood Pressure	>20 kg: (Lower limit+5) mmHg~270 mmHg ((Lower limit+0.7) kPa~35.9 kPa) 10~20 kg: (Lower limit+5) mmHg~200 mmHg ((Lower limit+0.7) kPa~26.6 kPa) <10 kg: (Lower limit+5) mmHg~135 mmHg ((Lower limit+0.7) kPa~18.0 kPa)				
Lower Limit of Systolic Blood Pressure	>20 kg: 41 mmHg~ (Upper limit-5) mmHg (5.3 kPa~ (Upper limit -0.7) kPa) 10~20 kg: 40 mmHg~ (Upper limit-5) mmHg (5.3 kPa~ (Upper limit-0.7) kPa) <10 kg: 40 mmHg~ (Upper limit-5) mmHg (5.3 kPa~ (Upper limit-0.7) kPa)				
Upper Limit of Mean Blood Pressure	>20 kg: (Lower limit+5) mmHg~230 mmHg ((Lower limit+0.7) kPa~30.6 kPa) 10~20 kg: (Lower limit+5) mmHg~165 mmHg ((Lower limit+0.7) kPa~21.9.0 kPa) <10 kg: (Lower limit+5) mmHg~110 mmHg ((Lower limit+0.7) kPa~14.6 kPa)				
Lower Limit of Mean Blood Pressure	>20 kg: 20 mmHg~ (Upper limit-5) mmHg (2.7 kPa~ (Upper limit-0.7) kPa) 10~20 kg: 20 mmHg~ (Upper limit-5) mmHg (2.7 kPa~ (Upper limit-0.7) kPa) <10 kg: 20 mmHg~ (Upper limit-5) mmHg (2.7 kPa~ (Upper limit-0.7) kPa)				
Upper Limit of Diastolic Blood	>20 kg: (Lower limit+5) mmHg~210 mmHg ((Lower limit+0.7) kPa~27.9 kPa)				

Appendix B Product Specifications

Pressure	10~20 kg: (Lower limit+5) mmHg~150 mmHg ((Lower limit+0.7) kPa~20.0 kPa) <10 kgv: (Lower limit+5) mmHg~100 mmHg ((Lower limit+0.7) kPa~13.3 kPa)
Lower Limit of Diastolic Blood Pressure	>20 kg: 11 mmHg~ (Upper limit-5) mmHg (1.4 kPa~ (Upper limit-0.7) kPa) 10~20 kg: 11 mmHg~ (Upper limit-5) mmHg (1.4 kPa~ (Upper limit-0.7) kPa) <10 kg: 10 mmHg~ (Upper limit-5) mmHg (1.3 kPa~ (Upper limit-0.7) kPa)

B.6.6 Temperature (Temp) Monitoring

Range	0°C ~ 50°C (32°F ~ 122°F)
Measuring Method	Thermal resistance method
Accuracy	The measuring tolerance is $\pm 0.1^{\circ}\text{C}$ (exclusive of probe tolerance)
Updating Interval	1 s
Nominal Resistance of Temp. Sensor	2252 Ω (25°C)
Type of Temp. Sensor	YSI400 Sensor or its Compatible Sensor (Precision $\pm 0.1^{\circ}\text{C}$)
Channel Number	2 channels
Resolution	0.1°C
Alarm Indication	Audible & visual alarm, data and parameter blinking, alarm message displayed in the screen, 3 levels of alarm.
Alarm Limit Specifications	Range (°C)
Upper Limit	(Lower Limit +1)°C ~ 50 °C
Lower Limit	0 °C ~ (Upper Limit -1)°C

B.6.7 IBP Monitoring

Measuring Method	Invasive direct measuring	
Volume displacement (Abbott)	<0.04 mm ³ /100mmHg	
IBP		
Measuring Range	-50 mmHg~350 mmHg	
Resolution	1 mmHg	
Accuracy	$\pm 2\%$ or ± 1 mmHg, whichever is higher (exclusive of the sensor)	
Updating Interval	1 s	
Alarm Limit Specifications	Range	
Art P1 P2	Upper Limit of Systolic Blood Pressure	(Lower limit+2) mmHg~350 mmHg (Lower limit+0.3)kPa~46.7 kPa)
	Upper Limit of Mean Blood Pressure	
	Upper Limit of Diastolic Blood Pressure	
PA	Upper Limit of Systolic Blood Pressure	(Lower limit+2) mmHg~120 mmHg ((Lower limit+0.3)kPa~16.0 kPa)
	Upper Limit of Mean Blood Pressure	
	Upper Limit of Diastolic Blood Pressure	
Art	Lower Limit of Systolic Blood Pressure	0 mmHg~(Upper limit-2)mmHg (0 kPa~(Upper limit-0.3)kPa)
	Lower Limit of Mean Blood Pressure	
	Lower Limit of Diastolic Blood Pressure	
P1 P2	Lower Limit of Systolic Blood Pressure	-50 mmHg~(Upper limit-2)mmHg (-6.7 kPa~(Upper limit -0.3)kPa)
	Lower Limit of Mean Blood Pressure	
	Lower Limit of Diastolic Blood Pressure	
PA	Lower Limit of Systolic Blood Pressure	-6 mmHg~(Upper limit-2)mmHg (-0.8 kPa~(Upper limit-0.3)kPa)
	Lower Limit of Mean Blood Pressure	
	Lower Limit of Diastolic Blood Pressure	
LAP RAP	Upper Limit of Mean Blood Pressure	(Lower limit+2)mmHg~40 mmHg ((Lower limit+0.3)kPa~5.3 kPa)

ICP CVP	Lower Limit of Mean Blood Pressure	-10 mmHg~(Upper limit-2)mmHg (-1.3 kPa~ (Upper limit-0.3)kPa)
------------	------------------------------------	--

B.6.8 CO₂ Monitoring (Optional)

Measuring Mode	Sidestream type (support 50ml/min pumping rate), mainstream type
Measuring Method	Infrared radiation absorption technique

Phasein Sidestream ISA Module

Measuring Method	Infrared Spectrum Method
Measuring Mode	Sidestream
Range	0%~25%
Accuracy	At 0%~25%: $\pm(0.2\%+2\%$ of reading) At 15%~25%: undefined
Unit selection	%, mmHg, kPa
Operating temperature	0 °C~50 °C (32 °F~122 °F)
Storage&Transport temperature	-40 °C~70 °C (-40 °F~158 °F)
Operating humidity	10 %~95 % (non-condensing)
Storage&Transport humidity	5 %~100 % (non-condensing)
Operating atmospheric pressure	52.5 kPa~120 kPa (393.75 mmHg~900 mmHg)
Storage&Transport atmospheric pressure	20 kPa~120 kPa (150 mmHg~900 mmHg)
Preheating time	< 10 s (Report the concentration and reach the highest precision)
Total System Response Time	< 3 s (use of 2m sampling tube)
Primary agent threshold (ISA OR+/AX+)	0.15 vol%. When an agent is identified, concentrations will be reported even below 0.15 vol%
Secondary agent threshold (ISA OR+/AX+)	0.2 vol% + 10% of total agent concentration
Airway Leakage	≤ 0.5 ml/min
Range of Breathing Rate	0 rpm~150 rpm
Accuracy of Breathing Rate	± 1 rpm
Asphyxia Alarm Delay	20 s, 25 s, 30 s, 35 s, 40 s, 45 s, 50 s, 55 s, 60 s
Sampling Flow Rate	50 ml/min ± 10 ml/min
Automatic Pressure Compensation	yes
Alarm Limit Specifications	Range
EtCO ₂ Upper Limit	(Lower Limit +2)mmHg~99 mmHg
EtCO ₂ Lower Limit	0 mmHg~(Upper Limit -2)mmHg
FiCO ₂ Upper Limit	0 mmHg~99 mmHg
awRR Upper Limit	(Lower limit+2) rpm~100 rpm
awRR Lower Limit	0 rpm~ (Upper limit-2) rpm

Phasein Mainstream IRMA Module

Measuring Method	Infrared Spectrum Method
Measuring Mode	Mainstream
Range	0%~25%
Accuracy	Range:0 %~15 %, Default: $\pm(0.2\%+ \text{reading } 2\%)$; Range:15%~25%, Default: Undefined.
Resolution	1 mmHg (0.133 kPa)

Appendix B Product Specifications

Unit selection	%, mmHg, kPa
Operating temperature	0 °C ~ 40 °C (32 °F ~ 104 °F)
Storage & Transport temperature	-40 °C ~ 75 °C (-40 °F ~ 167 °F)
Operating humidity	10 % ~ 95 % (non-condensing)
Storage & Transport humidity	5 % ~ 100 % (non-condensing)
Operating atmospheric pressure	52.5 kPa ~ 120 kPa (393.75 mmHg ~ 900 mmHg)
Storage & Transport atmospheric pressure	50 kPa ~ 120 kPa (375 mmHg ~ 900 mmHg)
Total System Response Time	< 1 s
Primary agent threshold	0.15 vol%. When an agent is identified, concentrations will be reported even below 0.15 vol% as long as apnea is not detected.
Secondary agent threshold	0.2 vol% + 10% of total agent concentration
Range of Breathing Rate	0 rpm ~ 150 rpm
Accuracy of Breathing Rate	±1 rpm
Asphyxia Alarm Delay	20 s, 25 s, 30 s, 35 s, 40 s, 45 s, 50 s, 55 s, 60 s
Automatic Pressure Compensation	yes
Alarm Limit Specifications	Range
EtCO ₂ Upper Limit	(Lower Limit +2) mmHg ~ 99 mmHg
EtCO ₂ Lower Limit	0 mmHg ~ (Upper Limit -2) mmHg
FiCO ₂ Upper Limit	0 mmHg ~ 99 mmHg
awRR Upper Limit	(Lower limit +2) rpm ~ 100 rpm
awRR Lower Limit	0 rpm ~ (Upper limit -2) rpm

Respironics Sidestream LoFlo Module

Measuring Method	Infrared Spectrum Method
Measuring Mode	Sidestream
Preheating time	Max. length of waveform is 20s. Full accuracy requirements satisfied after 2min (environment temp.: 25°C)
Range	0% ~ 19.7% (0 mmHg ~ 150 mmHg) (0 kPa ~ 20 kPa)
Resolution	0.1 mmHg 0 mmHg ~ 69 mmHg 0.25 mmHg 70 mmHg ~ 150 mmHg
Stability	Short-term drift: ≤ 0.8 mmHg (0.1 kPa) within 4h Long-term drift: accuracy maintained within 120h.
Unit selection	%, mmHg, kPa
Operating temperature	0 °C ~ 40 °C (32 °F ~ 104 °F)
Storage temperature	-40 °C ~ 70 °C (-40 °F ~ 158 °F)
Operating humidity	10 % ~ 90 % (non-condensing)
Storage humidity	10 % ~ 90 % (non-condensing)
Storage atmospheric pressure	53.33 kPa ~ 106.67 kPa (400 mmHg ~ 800 mmHg)
Accuracy (Gas Temp. at 25°C)	0 mmHg ~ 40 mmHg (0 kPa ~ 5.3 kPa), ±2 mmHg (0.27 kPa) 41 mmHg ~ 70 mmHg (5.5 kPa ~ 9.3 kPa), ±5% of the reading 71 mmHg ~ 100 mmHg (9.4 kPa ~ 13.3 kPa), ±8% of the reading 101 mmHg ~ 150 mmHg (13.4 kPa ~ 20 kPa), ±10% of the reading (When the breathing rate is > 80 rpm, all ranges are ±12% of the reading)
Total System Response Time	< 3 s
Range of Breathing Rate	2 rpm ~ 150 rpm

Accuracy of Breathing Rate	±1 rpm
Asphyxia Alarm Delay	20 s, 25 s, 30 s, 35 s, 40 s, 45 s, 50 s, 55 s, 60 s
Sampling Flow Rate	≥50 ml/min(100Hz)
Automatic Pressure Compensation	no
Alarm Limit Specifications	Range
EtCO ₂ Upper Limit	(Lower Limit +2) mmHg~99 mmHg
EtCO ₂ Lower Limit	0 mmHg~(Upper Limit -2) mmHg
FiCO ₂ Upper Limit	0 mmHg~99 mmHg
awRR Upper Limit	(Lower limit+2) rpm~100 rpm
awRR Lower Limit	0 rpm~ (Upper limit-2) rpm

Respironics Mainstream CAPNOSTAT5 Module

Measuring Method	Infrared Spectrum Method
Measuring Mode	Mainstream
Preheating time	Max. length of waveform is 15s. Full accuracy requirements satisfied after 2min (environment temp.: 25°C)
Range	0%~19.7% (0 mmHg~150 mmHg) (0 kPa~20 kPa)
Resolution	0.1 mmHg 0 mmHg~69 mmHg 0.25 mmHg 70 mmHg~150 mmHg
Stability	Short-term drift: ≤0.8 mmHg (0.1 kPa) within 4h Long-term drift: accuracy maintained within 120h.
Rise Time	< 60 ms
Unit selection	%, mmHg, kPa
Operating temperature	0 °C~45 °C(32 °F~113 °F)
Storage temperature	-40 °C~70 °C(-40 °F~158 °F)
Operating humidity	10 %~90 % (non-condensing)
Storage humidity	0 %~90 % (non-condensing)
Storage atmospheric pressure	50 kPa~106 kPa(375 mmHg~795 mmHg)
Accuracy (Environment Temp. at 35°C)	0 mmHg~40 mmHg (0 kPa~5.3 kPa), ±2 mmHg (0.27 kPa) 41 mmHg~70 mmHg (5.5 kPa~9.3 kPa), ±5% of the reading 71 mmHg~100 mmHg (9.4 kPa~13.3 kPa), ±8% of the reading 101 mmHg~150 mmHg (13.4 kPa~20 kPa), ±10% of the reading
Range of Breathing Rate	0 rpm~150 rpm
Accuracy of Breathing Rate	±1 rpm
Asphyxia Alarm Delay	20 s, 25 s, 30 s, 35 s, 40 s, 45 s, 50 s, 55 s, 60 s
Sampling Flow Rate	100 Hz
Automatic Pressure Compensation	no
Alarm Limit Specifications	Range
EtCO ₂ Upper Limit	(Lower Limit +2)mmHg~99 mmHg
EtCO ₂ Lower Limit	0 mmHg~(Upper Limit -2)mmHg
FiCO ₂ Upper Limit	0 mmHg~99 mmHg
awRR Upper Limit	(Lower limit+2) rpm~100 rpm
awRR Lower Limit	0 rpm~ (Upper limit-2) rpm

Kingst KM7002-V33/KM7003-V40 Sidestream Module

Measuring Method	Non-scattering Infrared Gas Analysis
Measuring Technology	Non-dispersive Infrared Gas Analysis (NIDR)
Range	0% ~ 20% (0 mmHg ~ 150 mmHg) (0 kPa ~ 20 kPa)
Protection Level / Type	BF
Preheating time	2 min at 25 °C
Response Time	50 ml/min
Delay Time	50 ml/min
Fully-automatic Drift Calibration	Automated according to the time and temperature. Time 5 s ~ 8 s
Operating temperature	5 °C ~ 50 °C (41 °F ~ 122 °F)
Storage temperature	-40 °C ~ 70 °C (-40 °F ~ 158 °F)
Environment humidity	30 % ~ 75 % (non-condensing)
Environment pressure	80 kPa ~ 106 kPa (600 mmHg ~ 795 mmHg)
Airway Leakage	< 0.1% (within the flow range above)
Accuracy	When < 5.0%: $\pm 0.3\%$ (± 2.0 mmHg) (0.27 kPa) When $\geq 5.0\%$: < 6% of the reading
Range of Breathing Rate	3 rpm ~ 150 rpm
Accuracy of Breathing Rate	1% or ± 1 rpm, whichever is higher.
Asphyxia Alarm Delay	30 s, 35 s, 40 s, 45 s, 50 s, 55 s, 60 s
Automatic Pressure Compensation	yes
Alarm Limit Specifications	Range
EtCO ₂ Upper Limit	(Lower Limit + 2) mmHg ~ 99 mmHg
EtCO ₂ Lower Limit	0 mmHg ~ (Upper Limit - 2) mmHg
FiCO ₂ Upper Limit	0 mmHg ~ 99 mmHg
awRR Upper Limit	(Lower limit + 2) rpm ~ 100 rpm
awRR Lower Limit	0 rpm ~ (Upper limit - 2) rpm

B.6.9 C.O. Specifications(Optional)

Measurement method	Thermodilution method	
Measuring range	C.O.:	0.01 ~ 20L/min
	TB:	23 ~ 43 °C
	TI:	0 ~ 27 °C
Resolution	C.O.:	0.01L/min
	TB, TI:	0.1 °C
Accuracy	C.O.:	$\pm 5\%$ or ± 0.1 L / min, whichever is greater
	TB, TI:	± 0.1 °C (without sensor)

Alarm Limit Specifications	Range
TB Upper Limit	(Lower Limit + 1.1) ~ 43 °C (Lower Limit + 2) ~ 109.4 °F
TB Lower Limit	23 ~ (Upper Limit - 1.1) °C 73.4 ~ (Upper Limit - 2) °F

B.6.10 AG Specifications (Optional)

Measurement method		Infrared radiation absorption characteristics			
Warm-up time		30 s			
Measuring range		CO ₂ :	0% ~ 25%		
		O ₂ :	0% ~ 100%		
		N ₂ O:	0% ~ 100%		
		Des:	0% ~ 25%		
		Sev:	0% ~ 25%		
		Enf:	0% ~ 25%		
		Iso:	0% ~ 25%		
		Hal:	0% ~ 25%		
		awRR:	0 rpm ~ 254 rpm		
Resolution		CO ₂ : 1 mmHg awRR: 1 rpm			
Measurement accuracy drift		Meet the accuracy requirements within 6 hours			
Suffocation alarm delay		20 s, 25 s, 30 s, 35 s, 40 s, 45 s, 50 s, 55 s, 60 s			
Update time		1 s			
IRMA AX+	Primary agent threshold	0.15 vol%. When an agent is identified, concentrations will be reported even below 0.15 vol% as long as apnea is not detected.			
	Secondary agent threshold	0.2 vol% + 10% of total agent concentration			
ISA OR+/AX+	Primary agent threshold	0.15 vol%. When an agent is identified, concentrations will be reported even below 0.15 vol% as long as apnea is not detected.			
	Secondary agent threshold	0.2 vol% + 10% of total agent concentration			
Interfering gases and steam effect					
gases and steam	Gas concentration	Carbon dioxide			
		IRMA CO ₂ , OR	IRMA AX+/OR+	Anesthetic gas	Nitrous oxide
N ₂ O ⁴⁾	60 vol%	-1&2)	-1&2)	-1)	-1)
Hal ⁴⁾	4	-1)	-1)	-1)	-1)
Enf, Iso, Sev ⁴⁾	5	Reading of +8% ³⁾		-1)	-1)
Des ⁴⁾	15	Reading of +12% ³⁾		-1)	-1)
Xe (Xenon) ⁴⁾	80	Reading of -10% ³⁾		-1)	-1)
He (Helium) ⁴⁾	50	Reading of -6% ³⁾		-1)	-1)
Quantitative spray ⁴⁾	Not for quantitative spray				
Ethanol ⁴⁾	0.3	-1)	-1)	-1)	-1)
Isopropano ⁴⁾	0.5	-1)	-1)	-1)	-1)
Acetone ⁴⁾	1	-1)	-1)	-1)	-1)
Methane ⁴⁾	3	-1)	-1)	-1)	-1)
Carbon monoxide ⁴⁾	1	-1)	-1)	-1)	-1)
Nitric oxide ⁵⁾	0.02	-1)	-1)	-1)	-1)
Oxygen ⁵⁾	100	-1&2)	-1&2)	-1)	-1)
<p>1): "Accuracy _ All conditions" The specification contains negligible interference and influence.</p> <p>2): for the probe which cannot be measured, nitrous oxide and / or the concentration of oxygen should be set. (IRMA CO₂ not measure Nitrous oxide or oxygen, IRMA AX+ not measure the oxygen)</p> <p>3): the gas concentration interference indicated, such as 50vol% of the helium usually leads to a decrease of 6% carbon dioxide readings. That is, if the measurements contain 5.0% vol% of carbon dioxide and 50vol% of nitrogen mixed gas, the actual measured concentration of carbon dioxide is usually as follows: (1-0.06)*5.0vol%=4.7vol% Carbon dioxide.</p> <p>4): meet the to EN ISO 21647:2004 standard.</p>					

5): supplement EN ISO 21647:2004 standard.

Alarm Limit Specifications	Range
EtCO ₂ Upper Limit	(Lower Limit +2)mmHg~99 mmHg
EtCO ₂ lower limit	0 mmHg~(Upper Limit -2)mmHg
FiCO ₂ Upper Limit	0 mmHg~99 mmHg
awRR Upper Limit	(lower limit+2) rpm~100 rpm
awRR lower limit	0 rpm~(upper limit-2) rpm
FiEnf Upper Limit	(lower limit+0.2)%~8%
FiEnf lower limit	0%~(upper limit-0.2)%
EtEnf Upper Limit	(lower limit+0.2)%~8%
EtEnf lower limit	0%~(upper limit-0.2)%
EtHal Upper Limit	(lower limit+0.2)%~8%
EtHal lower limit	0%~(upper limit-0.2)%
Filso Upper Limit	(lower limit+0.2)%~8%
Filso lower limit	0%~(upper limit-0.2)%
Etlso Upper Limit	(lower limit+0.2)%~8%
Etlso lower limit	0%~(upper limit-0.2)%
EtSev Upper Limit	(lower limit+0.2)%~10%
EtSev lower limit	0%~(upper limit-0.2)%
FiSev Upper Limit	(lower limit+0.2)%~10%
FiSev lower limit	0%~(upper limit-0.2)%
EtDes Upper Limit	(lower limit+0.2)%~22%
EtDes lower limit	0%~(upper limit-0.2)%
FiDes Upper Limit	(lower limit+0.2)%~22%
FiDes lower limit	0%~(upper limit-0.2)%
FiO ₂ Upper Limit	(lower limit+16) mmHg~760 mmHg ((lower limit+2.1) kPa~101.1 kPa)
FiO ₂ lower limit	137 mmHg~(upper limit-16) mmHg (18.3 kPa~(upper limit-2.1) kPa)
EtO ₂ Upper Limit	(lower limit+16) mmHg~760 mmHg ((lower limit+2.1) kPa~101.1 kPa)
EtO ₂ lower limit	137 mmHg~(upper limit-16) mmHg (18.3 kPa~(upper limit-2.1) kPa)
FiN ₂ O Upper Limit	(lower limit+2)%~82%
FiN ₂ O lower limit	0%~(upper limit-2)%
EtN ₂ O Upper Limit	(lower limit+2)%~100%
EtN ₂ O lower limit	0%~(upper limit-2)%

B.6.11 Recorder Specifications

Recorder	To record the animal information, the hospital information, waveform, parameters and others displayed in the screen
Method	Thermal array recorder
Printing Paper	Thermal paper
Print Resolution	8 dots/mm on Y-Axis
Delay Characteristics	≤0.5 mm
Amplitude-frequency Characteristics	Monitor Mode: 0.5 Hz~40 Hz; Diagnose Mode: 0.05 Hz~150 Hz.
Time Constant	≥0.3 s

Appendix C Alarm Information

◆ Physiological Alarm Information

Physiological Parameters		
Alarm Information	Triggering Condition	Treatment Measure
xx Too High	xx value exceeds the alarm upper limit.	Check the physiological condition of the animal and confirm if the setting of animal type and alarm limit is suitable to the animal.
xx Too Low	xx exceeds the alarm lower limit.	
Attention: xx represents the physiological parameter or name of a module, e.g. HR, ST- I , SpO ₂ , NIBP Systolic Blood Pressure and RR, AG, etc.		
ECG		
Alarm Information	Triggering Condition	Treatment Measure
ECG Signal Too Weak	The animal ECG signal is too weak.	Check the animal state, electrode and lead cable.
Asystole	Heart beat NOT detected when preset cardiac arrest threshold time has passed	If the animal suffers arrhythmia, check the animal state, electrode and lead cable. Check if the setting of arrhythmia trigger threshold is suitable to the animal.
VFib/VTac	Fibrillating waves last consistently for 6s//Dominant rhythm of the adjacent ventricular heart beats (V) and the heart rate is greater than the upper limit of ventricular tachycardia	
Extreme Tachycardia	Heart rate exceeds extreme tachycardia threshold	
Extreme Bradycardia	Heart rate lower than extreme bradycardia threshold	
Ventricular Rhythm	Lead rhythm of the adjacent ventricular beat exceeding the number of idioventricular rhythm threshold, and the heart rate is lower than VT rate.	
Ventricular Bigeminy	Rhythm N, V, N and V	
Ventricular Trigeminy	Rhythm N, N, V, N, N, V	
Irregular Rhythm	Continuous irregular rhythm	
PVCs/min	PVCs/min exceeds preset higher limit	
Run PVCs > 2	More than 2 continuous PVCs in the last minute	
Couplet PVCs	Paired PVCs detected in the last minute	
R on T	R on T detected within the last minute	
Multiform PVCs	Ventricular premature of 2 or more forms is detected in the last minute	
HeartBeat Pause	Not detecting heart pacing within preset cardiac arrest threshold time	
Missed Beats	Unable to detect the heart pacing within 1.75 times of the mean RR period when the heart rate is <100, or unable to detect the heart pacing in 1s when the heart rate is >100.	
Pacemaker NOT Capture	Asystole with pace-making pulse in the last minute (Only applicable to pacemaker-wearing animals)	The pacemaker has problem. Please check the pacemaker.
Pacemaker Not Pace	No pace-making pulse detected within a period that is 1.75 times the average R-R intervals (Only applicable to pacemaker-wearing animals)	

Resp		
Alarm Information	Triggering Condition	Treatment Measure
Resp Apnea(Resp)	No breathing signal within the preset time of respiratory asphyxia	Check the animal state, electrode and lead cable.
Resp Heartbeat Interrupt	The heart beat of the animal interferes with the respiration.	
CO₂		
Alarm Information	Triggering Condition	Treatment Measure
Resp Apnea (CO ₂)	The animal has no breath, or the breathing signal is too weak.	Check the animal's state, accessories and airway connection.
AG		
Alarm Information	Triggering Condition	Treatment Measure
Resp Apnea(AG)	Animal can't breathe, or respiratory signal is too weak.	Check the condition of the animal, accessories and airway connections.

◆ **Technical Alarm Information**

Communication Module		
Alarm Information	Triggering Condition	Treatment Measure
xx Communicate Error	Module not connected to host, or initialization failed, or error with module configuration	Restart the equipment. If the error remains, please contact the manufacturer for repair.
xx Communication Stopped	Problem with the communication between module and host	Restart the equipment. If the error remains, please contact the manufacturer for repair.
ECG		
Alarm Information	Triggering Condition	Treatment Measure
ECG RLF C123456 Lead Off	The connection between the electrode and the animal is loose or fallen, or the connection between lead line and main cable is loosened. (Integrated display is used for showing all alarms, so that the user may easily view all the information on a lead off.).	Check the connection between electrode and animal, as well as the connection between lead line and main cable.
NIBP		
Alarm Information	Triggering Condition	Treatment Measure
NIBP Measure Timeout	Failure occurs during measuring; resulting in the system cannot make an analysis and calculation.	Check the animal connection or change the cuff. Then, restart the equipment to try again. If the error remains, please contact the manufacturer for repair.
NIBP Pressure Outrange	The animal's blood pressure exceeds the measuring range.	Check the airway connection or change the cuff. If the error remains, please contact the manufacturer for repair.
NIBP Pressure Guard	The airway might be blocked.	Check the airway and measure again.
NIBP Arm Movement	The animal arm has moved.	Check the animal condition and stop the animal from moving the arm.
NIBP Signal Too Weak	It might be that the animal's pulse is too weak or the cuff is too loose.	Check the animal condition and put the cuff to an appropriate position. If the error remains, please change the cuff. If the problem remains unsolved, please contact the manufacturer for repair.
Cuff Type Error	The cuff is not compatible with the setting of animal type.	Confirm the animal type or change the cuff.
Cuff Leakage	The NIBP cuff is not correctly placed, or not properly connected, or the airway has leakage.	Check the airway connection or change the cuff. If the error remains, please contact the manufacturer for repair.

Cuff Loose	The NIBP cuff is not correctly placed, or not properly connected, or the airway has leakage.	Check the air tube connection or change the cuff. If the error remains, please contact the manufacturer for repair.
Cuff Enlaced or Air-Logged	The cuff or airway is blocked.	Check the airway and measure again. If the error remains, please contact the manufacturer for repair.
NIBP Measure Failed	During measuring, the system failed and cannot make analysis.	Check the animal condition; and check the connection or change the cuff. If the error remains, please contact the manufacturer for repair.
IBP System Error	Air pump, A / D sampling or pressure sensor error, or pointer error in the software running, or system needs to be calibrated.	Please contact the manufacturer for repair.
SpO₂		
Alarm Information	Triggering Condition	Treatment Measure
SpO ₂ Sensor Off	The sensor is fallen from the animal or module, resulting in error.	Check the sensor connection.
SpO ₂ Sensor Disconnect	SpO ₂ probe is not properly connected.	Check the connection of SpO ₂ probe.
Resp		
Alarm Information	Triggering Condition	Treatment Measure
Resp Module Interrupt	The module circuit is interfered with	Restart the equipment. If the error remains, please contact the manufacturer for repair.
Temp		
Alarm Information	Triggering Condition	Treatment Measure
T Module Disconnect	The temperature probe is not correctly connected or it is damaged.	Check the temperature probe and its connection.
The measured values beyond the measurement range	The Temperature measurement result is not within the ranging of 0 °C ~ 50 °C.	Check if the type of temperature probe is consistent with the setting of the monitor. Check if the temperature probe is not well connected or damaged.
CO₂		
Alarm Information	Triggering Condition	Treatment Measure
CO ₂ Sensor Off	The CO ₂ sensor is not correctly connected.	Confirm that the CO ₂ sensor has been correctly connected.
CO ₂ Sensor Too Hot	The CO ₂ sensor temperature is too high.	Check and stop using or change the sensor.
CO ₂ Sensor Too Cold	The CO ₂ sensor temperature is too low	
CO ₂ Pressure Too High	The pressure of airway is abnormal	Check the animal and airway connection. Then restart the monitor.
CO ₂ Pressure Too Low		
CO ₂ Airpressure Too High	The environment where the monitor is located affects the pressure.	Check the airway connection and confirm if the environment conforms to the monitor specifications and if there is any special factor affecting the environment pressure.
CO ₂ Airpressure Too Low		
CO ₂ Gascircuit Jam	The airway is blocked	Check the airway and eliminate the blocking.
CO ₂ Basin Off	The water bath is improperly connected.	Check the water bath connection.
CO ₂ Zero Error	The airway is improperly connected.	Check the airway connection. Make zero calibration again after the sensor temperature is stabilized.
CO ₂ System Error	The system has failed.	Unplug and insert this module, or restart the monitor.
CO ₂ Hardware Error	The CO ₂ module has failed	Unplug and insert this module, or restart the monitor.
CO ₂ Accurate Outrange	The module exceeds the accuracy range for normal working.	Check the setting and measure again.
CO ₂ Temp Outrange	The module exceeds the range of normal working temperature.	The module will be automatically restarted when it is returned to the range of normal working temperature.
CO ₂ Airpressure Outrange	The module exceeds the normal working range.	Check the setting and measure again.

Appendix C Alarm Information

CO ₂ Sensor Preheating	The CO ₂ sensor module is started and being preheated.	Wait
CO ₂ Zero Progress	CO ₂ Being Zero Calibration	Wait
CO ₂ Zero Base Inaccurate, Please Zero	The CO ₂ reading is incorrect	Ensure if the airway is correctly connected. Carry out zero calibration after the sensor temperature is stabilized.
CO ₂ Replace Adapter	CO ₂ Requiring Oxygen Range Calibration	Please execute one calibration operation.
CO ₂ Sensor Software Error	The CO ₂ module has failed	Reinsert the module or restart the monitor.
CO ₂ Airway Adapter Off	The airway adaptor is abnormal.	Check the airway and eliminate the blocking.
CO ₂ Pump Shut	CO ₂ Pump Closed	Confirm if CO ₂ pump is closed.
CO ₂ Calibrate Error	The CO ₂ calibration is wrong	Recalibrate.
C.O.		
Alarm Information	Triggering Condition	Treatment Measure
TB Sensor Off	The sensor is not connected or incorrectly connected.	Check the sensor connection. Reconnect it.
IBP		
Alarm Information	Triggering Condition	Treatment Measure
xx Sensor Off (xx refers to an IBP label)	The sensor is not connected or incorrectly connected.	Check the sensor connection. Reconnect it.
Others		
Alarm Information	Triggering Condition	Treatment Measure
Recorder Initial Error	Recorder initialization error	Restart the equipment
Recorder Out of Paper	Recorder no paper or paper position wrong	Check the print paper and reinstall it.
Recorder Serial Error	The recorder serial port communication has an error	Clear the print task and restart the equipment
Recorder Uninstall	The recorder is improperly installed	Check the recorder installation and restart the equipment.
Head of Print Hot	The recorder has worked too long	Clear the print task and output the records after the machine has cooled.
Voltage of Battery Too Low	The battery voltage is low and cannot maintain long-time monitoring	Switch to AC power supply. Power supply by battery can only be used when the battery is fully recharged.
Very Low Voltage, Shortly Logout	The battery voltage is too low. To avoid data loss due to low power, the system will soon activate the automatic shutdown procedure.	Switch to AC power supply. Power supply by battery can only be used when the battery is fully recharged.
AG		
Alarm Information	Triggering Condition	Treatment Measure
AG Sensor Off	AG sensor is not connected	Confirm that the AG sensor has been correctly connected.
AG Sensor Too Hot	AG sensor temperature is too high	Check and stop using or change the sensor.
AG Sensor Too Cold	AG sensor temperature is too low	
AG Pressure Too High	Airway pressure is abnormal	Check the animal and airway connection. Then restart the monitor.
AG Pressure Too Low		
AG Airpressure Too High	The monitor environment affects the pressure	Check the airway connection and confirm if the environment conforms to the monitor specifications and if there is any special factor affecting the environment pressure.
AG Airpressure Too Low		

AG Gascircuit Jam	Airway clogged	Check the airway and eliminate the blocking.
AG Basin Off	Water tank isn't connected properly	Check the water bath connection.
AG Zero Error	Airway isn't connected properly	Check the airway connection. Make zero calibration again after the sensor temperature is stabilized.
AG system error	System failure	Unplug and insert this module, or restart the monitor.
AG Hardware Error	AG module failure	Unplug and insert this module, or restart the monitor.
AG CO ₂ Accurate Outrang	The module exceeds the accuracy range of normal working	Check the setting and measure again.
AG Temp Outrange	The module exceeds the temperature range of normal working	The module will be automatically restarted when it is returned to the range of normal working temperature.
AG Airpressure Outrange	The module exceeds the range of normal working	Check the setting and measure again.
AG Sensor Preheating	AG sensor module is started and preheating	Wait
AG Zero Progress	AG is zeroing	Wait
AG Zero Base Inaccurate, Please Zero	AG reading inaccurate	Ensure if the airway is correctly connected. Carry out zero calibration after the sensor temperature is stabilized.
AG Replace Adapter	Replace adapter	Wait for the replacement is completed
AG Replace Oxygen Sensor	Replace oxygen sensor	Wait for the replacement is completed
AG Sample Pipe Off	AG sampling pipe off	Check the airway and eliminate the blocking.
AG Need Oxygen Calibrate	AG needs oxygen calibration	Perform the calibration operation
AG Need Oxygen Range Calibrate	AG requires oxygen range calibration	Perform the calibration operation
AG Sensor Software Error	AG module failure	Remove and reinsert the module or restart the monitor
AG Motor Speed Out of Bounds	AG motor speed overrun	Remove and reinsert the module or restart the monitor
AG Factory Calibrate Info Lost	AG factory calibration information is lost	Contact the manufacturer
AG Oxygen Sensor Error	AG oxygen sensor error	Contact the manufacturer
AG Oxygen Port Failure	AG oxygen port failure	Check AG oxygen port state or restart the monitor
AG N ₂ O Outside Accuracy Range	The module exceeds the accuracy range of normal working	Check the settings and re-measure
AG Oxygen Outside Accuracy range		
AG Agent Outside Accuracy Range		
AG Agent Info Unreliable	AG anesthetic gas information unreliable	Contact the manufacturer
AG Airway Adapter Off	Airway adapter is abnormal	Check the airway and eliminate the clogging
AG Pump Shut	AG air pump off	Check whether AG air pump is closed
AG Calibrate Error	AG calibration error	Re-calibrate
AG Command Send Error	AG command sending fails	Restart the monitor
AG Mixed Anesthetic Gas	AG has mixed anesthetic gases	/



Attention

- When different levels of alarms exist together, the alarm sound of the highest level will be heard.
- Under ' Alarm Pause ' state, the monitor will not process any alarm information.

-- The Blank Page --

Appendix D Factory Default Setup

D.1 Animal Demographics

Animal Demographics	Default Setup
Animal Cat.	>20kg
Paced	No

D.2 Alarm

Alarm Setup		Default Setup
Global	Alarm Volume	8
	Alarm Delay	5 s
	ST Alarm Delay	30 s
	Limit Display	On
Alarm Config	Pause Time	120 s
	Alarm Mode	Unlatch
	Silence Other Bed	On
	PAR.Flash	On
	Full Prohibiton	Off
	1st Forbid Time	3 min
	2nd Forbid Time	10 min
	Fatal Arrh.Off	Disable
	MIN Alarm Volume	2
	Reminder Tone	On
	Reminder Volume	5
	Reminder Interval	1 min
	Alarm Sound	ISO
	Alarm-H Interval	10 s
Alarm-M Interval	20 s	
Alarm-L Interval	20 s	

D.3 Alarm Limit

D.3.1 >20kg

		High	Low	Level	On/Off	Record
		HR/PR(bpm)	120	50	Mid	On
RR(rpm)	30	8	Mid	On	Off	
SpO ₂ (%)	100	90	Mid	On	Off	
NIBP-S(mmHg)	160	90	Mid	On	Off	
NIBP-D(mmHg)	90	50	Mid	On	Off	
NIBP-M(mmHg)	110	60	Mid	On	Off	
T1(°C)	39.0	36.0	Mid	On	Off	
T2(°C)	39.0	36.0	Mid	On	Off	
TD(°C)	0.2	/	Mid	On	Off	
TB(°C)	43.0	23	Mid	On	Off	
Art-S(mmHg)	160	90	Mid	On	Off	
Art-D(mmHg)	90	50	Mid	On	Off	
Art-M(mmHg)	110	70	Mid	On	Off	
CVP-M(cmH ₂ O)	13.6	0	Mid	On	Off	
EtCO ₂ (%)	6.6	2.0	Mid	On	Off	
FiCO ₂ (%)	0.5	/	Mid	On	Off	
awRR(rpm)	30	8	Mid	On	Off	
EtCO ₂ (AG)(%)	30	0	Mid	On	Off	
FiCO ₂ (AG)(%)	30	/	Mid	On	Off	
awRR(AG)(rpm)	30	8	Mid	On	Off	
FiAA1	/	/	Mid	Off	Off	
EtAA1	/	/	Mid	Off	Off	
FiAA2	/	/	Mid	Off	Off	
EtAA2	/	/	Mid	Off	Off	
FiO ₂ (%)	100	18.2	Mid	On	Off	
EtO ₂ (%)	87.9	18.2	Mid	On	Off	
FiN ₂ O	53	0	Mid	On	Off	
EtN ₂ O	55	0	Mid	On	Off	
ST Alarm	ST-X (mV)	0.2	-0.2	Mid	Off	Off

Attention: ' X ' represents Lead I , II , III, aVR, aVL, aVF, V, V1, V2, V3, V4, V5 or V6.

AA1/AA2 representative one of the five anesthetic gas such as Des (Desflurane), Iso (isoflurane) and Enf (enflurane), Sev (sevoflurane) and Hal (halothane)

D.3.2 10~20kg

		High	Low	Level	On/Off	Record	
Parameter Alarm	HR/PR(bpm)	160	75	Mid	On	Off	
	RR(rpm)	30	8	Mid	On	Off	
	SpO ₂ (%)	100	90	Mid	On	Off	
	NIBP-S(mmHg)	120	70	Mid	On	Off	
	NIBP-D(mmHg)	70	40	Mid	On	Off	
	NIBP-M(mmHg)	90	50	Mid	On	Off	
	T1(°C)	39.0	36.0	Mid	On	Off	
	T2(°C)	39.0	36.0	Mid	On	Off	
	TD(°C)	0.2	/	Mid	On	Off	
	Art-S(mmHg)	120	70	Mid	On	Off	
	Art-D(mmHg)	70	40	Mid	On	Off	
	Art-M(mmHg)	90	50	Mid	On	Off	
	CVP-M(cmH ₂ O)	5.4	0	Mid	On	Off	
	EtCO ₂ (%)	6.6	2.6	Mid	On	Off	
	FiCO ₂ (%)	0.5	/	Mid	On	Off	
	awRR(rpm)	30	8	Mid	On	Off	
	EtCO ₂ (AG) (%)	30	0	Mid	On	Off	
	FiCO ₂ (AG) (%)	30	/	Mid	On	Off	
	awRR (AG) (rpm)	30	8	Mid	On	Off	
	FiAA1	/	/	Mid	Off	Off	
	EtAA1	/	/	Mid	Off	Off	
	FiAA2	/	/	Mid	Off	Off	
	EtAA2	/	/	Mid	Off	Off	
	FiO ₂ (%)	100	18.2	Mid	On	Off	
	EtO ₂ (%)	87.9	18.2	Mid	On	Off	
	FiN ₂ O	53	0	Mid	On	Off	
	EtN ₂ O	55	0	Mid	On	Off	
	ST Alarm	ST-X(mV)	0.2	-0.2	Mid	On	Off

Attention: ' X ' represents Lead I , II , III, aVR, aVL, aVF, V, V1, V2, V3, V4, V5 or V6.

AA1/AA2 representative one of the five anesthetic gas such as Des (Desflurane), Iso (isoflurane) and Enf (enflurane), Sev (sevoflurane) and Hal (halothane)

D.3.3 <10 kg

Parameter Alarm		High	Low	Level	On/Off	Record
		HR/PR(bpm)	200	100	Mid	On
	RR(rpm)	100	30	Mid	On	Off
	SpO ₂ (%)	95	90	Mid	On	Off
	NIBP-S(mmHg)	90	40	Mid	On	Off
	NIBP-D(mmHg)	60	20	Mid	On	Off
	NIBP-M(mmHg)	70	25	Mid	On	Off
	T1(°C)	39.0	36.0	Mid	On	Off
	T2(°C)	39.0	36.0	Mid	On	Off
	TD(°C)	0.2	/	Mid	On	Off
	Art-S(mmHg)	90	55	Mid	On	Off
	Art-D(mmHg)	60	20	Mid	On	Off
	Art-M(mmHg)	70	35	Mid	On	Off
	CVP-M(cmH ₂ O)	5.4	0	Mid	On	Off
	EtCO ₂ (%)	5.9	3.9	Mid	On	Off
	FiCO ₂ (%)	0.5	/	Mid	On	Off
	awRR(rpm)	100	30	Mid	On	Off
	EtCO ₂ (AG) (%)	30	0	Mid	On	Off
	FiCO ₂ (AG) (%)	30	/	Mid	On	Off
	awRR (AG) (rpm)	100	30	Mid	On	Off
	FiAA1	/	/	Mid	Off	Off
	EtAA1	/	/	Mid	Off	Off
	FiAA2	/	/	Mid	Off	Off
	EtAA2	/	/	Mid	Off	Off
	FiO ₂ (%)	90	18.2	Mid	On	Off
	EtO ₂ (%)	87.9	18.2	Mid	On	Off
	FiN ₂ O	53	0	Mid	On	Off
	EtN ₂ O	55	0	Mid	On	Off

Attention: AA1/AA2 representative one of the five anesthetic gas such as Des (Desflurane), Iso (isoflurane) and Enf (enflurane), Sev (sevoflurane) and Hal (halothane)

D.4 Screen Setup

Screen Setup		Default Setup
Screen Config	Interface Type	Standard
	Screen Brightness	10
	Panel Backlight	Off
	Key Volume	2
	Minitrend Length	1 h
	Menu Help	On

D.5 User Maintain

User Maintain		Default Setup
Unit Setup	Height	cm
	Weight	kg
	CO ₂	%
	Blood Press	mmHg
	CVP	cmH ₂ O
	Temp	°C
	ST Voltage	mV
	O ₂	kPa
	TB	°C
	Show Unit	Disable
Other Setup	Notch Filter	50 Hz
	ECG Off Level	Low
	SpO ₂ Off Level	Low
	Tone Modulation	On
	While DC	Fan On
	Record Bold Curve	Off
	Curve Draw	Ladder
	Wave Lines	Thin
	Auto Screen Layout	On

D.6 ECG

ECG		Default Setup
ECG Setup	Filter	Diagnose
	ECG1	II
	ECG2	I
	ECG Gain	×1
	Sweep	25.0 mm/s
	Alarm Source	Auto
	QRS Volume	6
	Notch Filter	On
	Screen	Normal
	Lead Set	5-Lead

Appendix D Factory Default Setup

	Paced	No
	Save Curve	II
	ST Use	ST Point
	Smart Lead Off	On
ST Analysis	ST Analysis	Off
	ST Waves Setup	ST- II
Arrhythmia Threshold (Not applicable to < 10kg)	QRS Pause	2 s
	Cardiac Arrest	4 s
	VT	100 bpm
	Sustained VT	15 s
	VR	5
	PVCs/min	10
	Extreme VT-H	140 bpm
	Extreme VB-L	30 bpm

Arrhythmia Analysis	Alarm On/Off	Alarm Level	Alarm Record
Asystole	On	High	Off
VFib/VTac	On	High	Off
VTac	On	High	Off
VB	On	High	Off
Extreme-Tachy	Off	Mid	Off
Extreme-Brady	Off	Mid	Off
Non-Sustained VT	Off	Mid	Off
VR	Off	Mid	Off
Run PVCs > 2	Off	Mid	Off
Couplet	Off	Mid	Off
R on T	Off	Mid	Off
V-Bigeminy	Off	Mid	Off
V-Trigeminy	Off	Mid	Off
PVCs/min	Off	Mid	Off
Multiform	Off	Mid	Off
PVC	Off	Mid	Off
HeartBeat Pause	Off	Mid	Off
Missed Beats	Off	Mid	Off
PNC	Off	Mid	Off

PNP	Off	Mid	Off
Tachy	Off	Mid	Off
Brady	Off	Mid	Off
Irr.Rhythm	Off	Mid	Off

D.7 NIBP

NIBP Setup	Default Setup
Initial Pressure	>20 kg: 160 mmHg (21.3 kPa) 10~20 kg: 140 mmHg (18.6 kPa) <10 kg: 90 mmHg (12.0 kPa)
Measure Mode	Manual
Interval	5 min
Vein Puncture Pressure	>20 kg: 80 mmHg (10.6 kPa) 10~20 kg: 60 mmHg (8.0 kPa) <10 kg: 30 mmHg (4.0 kPa)

D.8 SpO₂

SpO ₂ Setup	Default Setup
NIBP Simul	Off
Sweep	25.0 mm/s
PR Source	Auto
Alarm Source	Auto
Pulse Volume	6
Sensitivity	Mid
	Normal (Only for Masimo SpO ₂)
Pump Show	On
Wave Fill	Off
Smart Tone Mode	Off (Only for Masimo SpO ₂)
Fast SAT Mode	Off (Only for Masimo SpO ₂)
SIQ View	Off (Only for Masimo SpO ₂)
Average Time	8 s (Only for Masimo SpO ₂)
Satseconds	10 (Only for Nellcor SpO ₂)

D.9 Resp

Resp Setup	Default Setup
Apnea Delay	10 s
Gain	×1
Sweep	12.5 mm/s
Read Lead	I
Detect.Mode	Auto

D.10 IBP

IBP Setup		Default Setup
Channel 1 Setup	Label	Art
	Scale	0~140
	Sweep	25.0 mm/s
	Filter	Normal
	Sensitivity	Mid
Channel 2 Setup	Label	CVP
	Scale	0~80
	Sweep	25.0 mm/s
	Filter	Normal
	Sensitivity	Mid

D.11 CO₂

CO₂ Setup	Default Setup
Apnea Delay	30 s
BTPS Compen	Off
O ₂ Compen	0%
N ₂ O Compen	0%
Des Compen	0%
Operate Mode	Measure
Flow Rate (For sidestream only)	50 ml/min
Wave Fill	Off
Scale	7.0
Sweep	12.5 mm/s
Pump Switch (For sidestream only)	On

D.12 C.O.

C.O. Setup	Default Setup
Alarm	On
Alm Lev	Med
Alm Rec	Off
BT High	39.0
BT Low	36.0
Comp. Const	0.542
Auto TI	Off
Manual TI	0.0
Temp Unit	°C
Interval	30

D.13 AG

AG Setup		Default Setup
AG Setup	Apnea Delay	20 s
	Operating Mode	Measure
	Pump Switch	On
	O2 Compen	0%
	CO2 Wave Fill	Off
	CO2 Scale	Off
	AA Scale	7.0
	N2O Scale	9.0
	O2 Scale	50.0
	Sweep	6.25 mm/s

D.14 PR

Other Setup	Default Setup
PR Source	Auto
Alarm Source	Auto
Pulse Volume	6

D.15 Other Setup

Other Setup		Default Setup
Output Setup	Analog Output	On
	Curve Select	II
Nurse Call Setup	Nurse Call	On
	Signal Type	Pulse Low
	Trigger Alarm Level	High, Medium, Low
	Trigger Type	Physiology, Technology
Trigger Manual Storage Waveform	Curve 1	I
	Curve 2	II
	Curve 3	Off

Appendix E EMC- Guidance and Manufacture's Declaration

E.1 Guidance and manufacture's declaration-electromagnetic emissions for all EQUIPMENT and SYSTEMS

Guidance and manufacturer's declaration – electromagnetic emission		
The Veterinary Monitor is intended for use in the electromagnetic environment specified below. The customer or the user of Veterinary Monitor should assure that it is used in such an environment.		
Emissions test	Compliance	Electromagnetic environment - guidance
RF emissions EN 55011	Group 1	The Veterinary Monitor uses RF energy only for its internal function. Therefore, its RF emissions are very low and are not likely to cause any interference in nearby electronic equipment.
RF emissions EN 55011	Class A	The Veterinary Monitor is not suitable for use in all establishments, including domestic establishments and those directly connected to the public low-voltage power supply network that supplies buildings used for domestic purposes.
Harmonic emissions EN 61000-3-2	Class A	
Voltage fluctuations / flicker emissions EN 61000-3-3	Complies	

E.2 Guidance and manufacture's declaration-electromagnetic immunity for all EQUIPMENT and SYSTEMS

Guidance and manufacturer's declaration – electromagnetic immunity			
The Veterinary Monitor is intended for use in the electromagnetic environment specified below. The customer or the user of the Veterinary Monitor should assure that it is used in such an environment.			
Immunity test	IEC 60601 test level	Compliance level	Electromagnetic environment - guidance
Electrostatic discharge (ESD) EN 61000-4-2	± 6 kV contact ± 8 kV air	± 6 kV contact ± 8 kV air	Floors should be wood, concrete or ceramic tile. If floors are covered with synthetic material, the relative humidity should be at least 30%.
Electrostatic transient / burst EN 61000-4-4	± 2 kV for power supply lines ± 1 kV for input/output lines	± 2 kV for power supply lines ± 1 kV for input/output line	Mains power quality should be that of a typical commercial or hospital environment.
Surge EN 61000-4-5	± 1 kV differential mode ± 2 kV common mode	± 1 kV differential mode ± 2 kV common mode	Mains power quality should be that of a typical commercial or hospital environment.
Voltage dips, short interruptions and voltage variations on power supply input lines EN 61000-4-11	< 5% UT (>95% dip in UT) for 0.5 cycle 40% UT (60% dip in UT) for 5 cycles 70% UT (30% dip in UT) for 25 cycles	< 5% UT (>95% dip in UT) for 0.5 cycle 40% UT (60% dip in UT) for 5 cycles 70% UT (30% dip in UT) for 25 cycles	Mains power quality should be that of a typical commercial or hospital environment. If the user of the Veterinary Monitor requires continued operation during power mains interruptions, it is recommended that the Veterinary Monitor be powered from an uninterruptible power supply or a battery.

	< 5% UT (>95% dip in UT) for 5 sec	< 5% UT (>95% dip in UT) for 5 sec	
Power frequency (50/60 Hz) magnetic field EN 61000-4-8	3 A/m	3 A/m	Power frequency magnetic fields should be at levels characteristic of a typical location in a typical commercial or hospital environment.
ATTENTION: UT is the a. c. mains voltage prior to application of the test level.			

E.3 Guidance and manufacture’s declaration-electromagnetic immunity for EQUIPMENT and SYSTEMS those are not LIFE-SUPPORTING

Guidance and manufacturer’s declaration – electromagnetic immunity			
The Veterinary Monitor is intended for use in the electromagnetic environment specified below. The customer or the user of the Veterinary Monitor should assure that it is used in such an environment.			
Immunity test	IEC 60601 test level	Compliance level	Electromagnetic environment - guidance
Conducted RF EN 61000-4-6	3 Vrms 150 kHz to 80 MHz	3 V	<p>Portable and mobile RF communications equipment should be used no closer to any part of the A100C Animal Doppler, including cables, than the recommended separation distance calculated from the equation applicable to the frequency of the transmitter.</p> <p>Recommended separation distance</p> $d = \left[\frac{3.5}{V_1} \right] \sqrt{P}$ $d = \left[\frac{3.5}{E_1} \right] \sqrt{P} \quad 80 \text{ MHz to } 800 \text{ MHz}$ $d = \left[\frac{7}{E_1} \right] \sqrt{P} \quad 800 \text{ MHz to } 2.5 \text{ GHz}$ <p>where p is the maximum output power rating of the transmitter in watts (W) according to the transmitter manufacturer and d is the recommended separation distance in metres (m).^b</p> <p>Field strengths from fixed RF transmitters, as determined by an electromagnetic site survey, ^a should be less than the compliance level in each frequency range.^b</p> <p>Interference may occur in the vicinity of equipment marked with the following symbol:</p> 
Radiated RF EN 61000-4-3	3 V/m 80 MHz to 2.5 GHz	3 V/m	
<p>ATTENTION 1 At 80 MHz and 800 MHz, the higher frequency range applies.</p> <p>ATTENTION 2 These guidelines may not apply in all situations. Electromagnetic is affected by absorption and reflection from structures, objects and people.</p>			

- a. Field strengths from fixed transmitters, such as base stations for radio (cellular/cordless) telephones and land mobile radios, amateur radio, AM and FM radio broadcast and TV broadcast cannot be predicted theoretically with accuracy. To assess the electromagnetic environment due to fixed RF transmitters, an electromagnetic site survey should be considered. If the measured field strength in the location in which the Veterinary Monitor is used exceeds the applicable RF compliance level above, the Veterinary Monitor should be observed to verify normal operation. If abnormal performance is observed, additional measures may be necessary, such as reorienting or relocating the Veterinary Monitor.
- b. Over the frequency range 150 kHz to 80 MHz, field strengths should be less than 3V/m.

E.4 Recommended separation distance between portable and mobile RF communications equipment and the EQUIPMENT or SYSTEM for EQUIPMENT or SYSTEM that are not LIFE-SUPPORTING

Recommended separation distances between portable and mobile RF communications equipment and the Veterinary Monitor			
The Veterinary Monitor is intended for use in an electromagnetic environment in which radiated RF disturbances are controlled. The customer or the user of the Veterinary Monitor can help prevent electromagnetic interference by maintaining a minimum distance between portable and mobile RF communications equipment (transmitters) and the Veterinary Monitor as recommended below, according to the maximum output power of the communications equipment			
Rated maximum output of transmitter W	Separation distance according to frequency of transmitter		
	150 kHz to 80 MHz $d = \left[\frac{3.5}{V_1} \right] \sqrt{P}$	80 MHz to 800 MHz $d = \left[\frac{3.5}{E_1} \right] \sqrt{P}$	800 MHz to 2.5 GHz $d = \left[\frac{7}{E_1} \right] \sqrt{P}$
0.01	0.12	0.12	0.23
0.1	0.38	0.38	0.73
1	1.2	1.2	2.3
10	3.8	3.8	7.3
100	12	12	23
For transmitters rated at a maximum output power not listed above the recommended separation distance d in metres (m) can be estimated using the equation applicable to the frequency of the transmitter, where P is the maximum output power rating of the transmitter in watts (W) according to the transmitter manufacturer.			
ATTENTION 1 At 80 MHz and 800 MHz, the separation distance for the higher frequency range applies.			
ATTENTION 2 These guidelines may not apply in all situations. Electromagnetic propagation is affected by absorption and reflection from structures, objects and people.			

-- The Blank Page --



Shenzhen Biocare Bio-Medical Equipment Co., Ltd.

Address: #16-1, Jinhui Road, Jinsha Community, Kengzi Sub-District,
Pingshan New District, 518122 Shenzhen, PEOPLE'S REPUBLIC OF CHINA

Tel: 86 -755 -33005899 Fax: 86-755-27960643

Website: <http://www.biocare.com.cn>